

# Washing Rack Solutions

for cGMP GEW Washers

# A comprehensive range

## – critical cleaning for your unique processing needs

The Getinge GEW Series of washer/dryers includes a variety of sizes to fit your needs. All models include a full traceability and validation package.



### GEW 888

#### A compact washer for small premises

For biotech/biopharmaceutical manufacturing or QC applications

The compact GEW 888 washer/dryer with an automatic vertical sliding door that does not require additional height above the washer is the ideal solution for space constraints. It can accommodate a broad range of items, from 50 L Nalgene bottles to small glassware. Service access can be configured from the front or side to accommodate your workflows.

- Single- or double-door models are available for single-side or pass-through operation
- Two independent wash levels deliver increased flexibility and throughput
- Low water consumption with only 40 liter (10,6 gal) per fill
- Chamber capacity: 469 L (17 ft<sup>3</sup>)
- Internal dimensions, W x H x D: 805 x 725 x 805 mm (31.8" x 28.5" x 31.8")
- Cross contamination barrier (CCB) available as option



### GEW 9109

#### Ideal for multipurpose applications

For biopharmaceutical manufacturing and QA/QC applications

The larger GEW 9109 washer/dryer is a multipurpose washer for cleaning glassware, filling line modules and equipment parts. Horizontal sliding doors minimize floor space needed for operation.

- Single- or double-door models are available for single-side or pass-through operation
- A two-port wash system allows for use of two level accessory racks thereby increasing productivity and reducing cycle costs
- Chamber capacity: 810 L (211.3 gal)
- Internal dimensions, W x H x D: 900 x 1000 x 900 mm (35.5" x 39.4" x 35.5")
- Cross contamination barrier (CCB) available as option



### GEW 101210 and GEW 131313

#### Designed for manufacturing

For biopharmaceutical manufacturing and bulk chemical/API production

These medium-sized washer/dryers include many standard features necessary for GMP compliance in cleaning of IBCs, carboys and equipment. A wide range of optional features are also available to make the models adaptable to a variety of applications. A variety of standard racks and an ergonomic transport trolley are available for common applications. Custom racks can also be designed and provided.

- Single- or double-door models are available for single-side or pass-through operation
- Glass doors are vertically hinged to save space
- Loading height: 710 mm (28")
- Chamber capacity:
  - GEW 101210: 1212 L (43 ft<sup>3</sup>) / GEW 131313: 2146 L (76 ft<sup>3</sup>)
- Internal dimensions, W x H x D:
  - GEW 101210: 1005 x 1200 x 1005 mm (39.6" x 47.2" x 39.5")
  - GEW 131313: 1300 x 1285 x 1285 mm (51" x 50.5" x 50.5")
- Cross contamination barrier (CCB) available as option



### GEW 131820

#### The largest, pit-mounted washer

For biopharmaceutical manufacturing and bulk chemical/API production

The GEW 131820 is the largest washer in the series. It is designed for pit mounting in a 500 mm (19.7") deep pit, allowing direct floor loading of large, heavy or bulky items. Where pit mounting is not possible, the machine may be floor mounted with a loading height of 500 mm (19.7"). Use for cleaning IBCs, bulk chemical containers, vessels, machine parts.

- Racks are application-specific to maximize throughput
- Single- or double-door models are available for single-side or pass-through operation
- Sliding doors save space and optimize ergonomics
- Chamber capacity: 4680 L (165 ft<sup>3</sup>)
- Internal dimensions, W x H x D: 1300 x 1800 x 2000 mm (51" x 70.9" x 78.7")
- Cross contamination barrier (CCB) available as option

Model	Configuration doors	Overall dimensions* W x H x D
GEW 888-1	Single	2003 x 2170 x 1076 mm (78.7" x 85.4" x 42.4")
GEW 888-2	Double	2003 x 2170 x 1170 mm (78.7" x 85.4" x 46.1")
GEW 888-1	Single (with SPFR option)	2365 x 2686 x 1125 mm ( 93.1" x 105.7" x 44.3")
GEW 888-2	Double (with SPFR option)	2365 x 2686 x 1170 mm ( 93.1" x 105.7" x 46.1")
GEW 9109-1	Single	2350 x 2243 x 1185 mm (92.5" x 88.3" x 46.6")
GEW 9109-2	Double	2350 x 2243 x 1320 mm (92.5" x 88.3" x 52")
GEW 9109-1	Single (with SPFR option)	2593 x 2243 x 1260 mm (102.1" x 88.3" x 49.6")
GEW 9109-2	Double (with SPFR option)	2593 x 2243 x 1320 mm (102.1" x 88.3" x 52")
GEW 101210-1	Single	2190 x 2485 x 1266 mm (86.2" x 97.8" x 49.8")
GEW 101210-2	Double	2190 x 2485 x 1345 mm (86.2" x 97.8" x 53")
GEW 101210-1	Single (with SPFR option)	2350 x 2485 x 1266 mm (92.5" x 97.8" x 49.8")
GEW 101210-2	Double (with SPFR option)	2350 x 2485 x 1345 mm (92.5" x 97.8" x 53")
GEW 131313-1	Single	2439 x 2604 x 1716 mm (96" x 102.5" x 67.6")
GEW 131313-2	Double	2439 x 2604 x 1947 mm (96" x 102.5" x 76.6")
GEW 131313-1	Single (with SPFR option)	2678 x 2604 x 1716 mm (105.4" x 102.5" x 67.6")
GEW 131313-2	Double (with SPFR option)	2678 x 2604 x 1947 mm (105.4" x 102.5" x 76.6")
GEW 131820-1	Single	3053 x 2850 x 2300 mm (120.2" x 112.2" x 90.6")
GEW 131820-2	Double	3053 x 2850 x 2600 mm (120.2" x 112.5" x 102.4")

\*Subject to modifications due to technical development



# GMP Washers Loading Equipment

– ensure cleaning efficacy with flexible loading solutions

Standard and customizable wash rack solutions for efficient loading of components and equipment used in biopharmaceutical production processes.

Smooth, uninterrupted production requires that the right components and equipment are available and

ready for use. You need the correct, ergonomically friendly loading equipment to ensure efficient use of chamber space and reliable cleaning efficacy. Getinge supports you with standard and customizable rack options for GEW GMP washer-dryers to accommodate a wide variety of loads.

Technical Data	
<b>Materials</b>	
Material 316 L	<input checked="" type="checkbox"/>
PFTE USP ClassVI & FDA approved	<input checked="" type="checkbox"/>
Surfaces electropolished	<input checked="" type="checkbox"/>
<b>Surface Finish</b>	
Material	0,8 µm
Weld seams	4 µm
Mechanical brushing of welds	<input type="checkbox"/>
<b>Documentation / Verification certificates / Services</b>	
Material certificate from Getinge Quality Assurance	<input checked="" type="checkbox"/>
Inspection certificate 3.1 as per EN 10204	<input type="checkbox"/>
Welding book	<input type="checkbox"/>
Weld inspection report with pictures	<input type="checkbox"/>

/  Standard / optional features  
Subject to change without notice.



# Basic Racks

Grid racks for glassware or machinery parts which do not require direct injection.

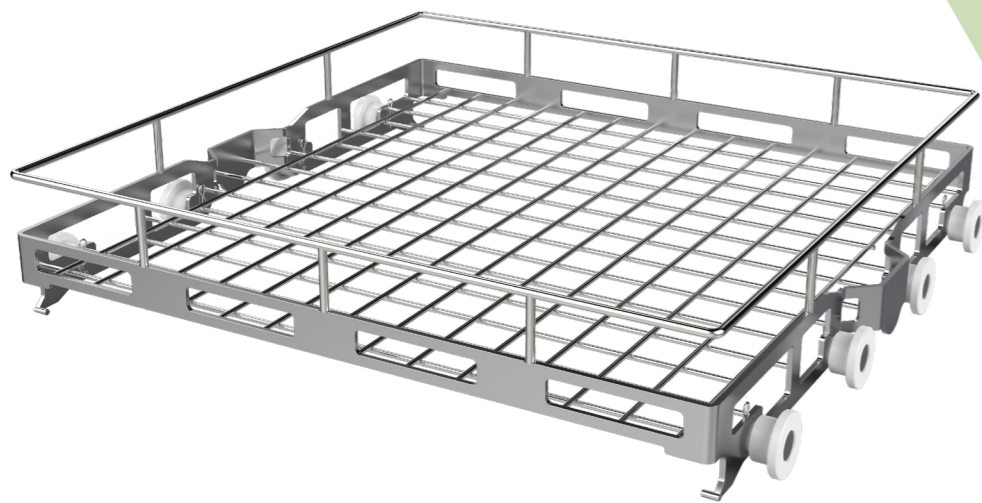

## Basic rack

Grid rack (50x50mm) allows loading of mesh baskets and miscellaneous accessories to wash large neck items

- Model 888 – Part Number:** 02300003
- Model 9109- Part Number:** 02270004
- Model 101210 – Part Number:** 02270004
- Model 131313 – Part Number:** 02280004

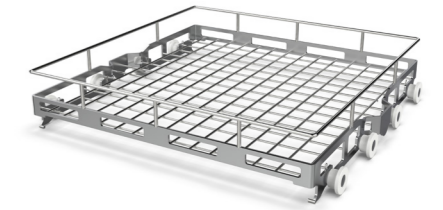

## Standard two level rack incl. basic + 1 ps type rack with spray arm

Grid rack (50x50mm) on two levels allows loading of mesh baskets and miscellaneous accessories to wash large neck items

- Model 101210 – Part Number:** AA02280021
- Model 9109- Part Number:** 02270015
- Model 131313 – Part Number:** AA02260023



## PSB basic rack with spray arm

Allows for mesh basket 50 x 50mm and miscellaneous accessories on upper level.

- Model 888 – Part Number:** 023000071



## WASH LOAD CONFIGURATIONS

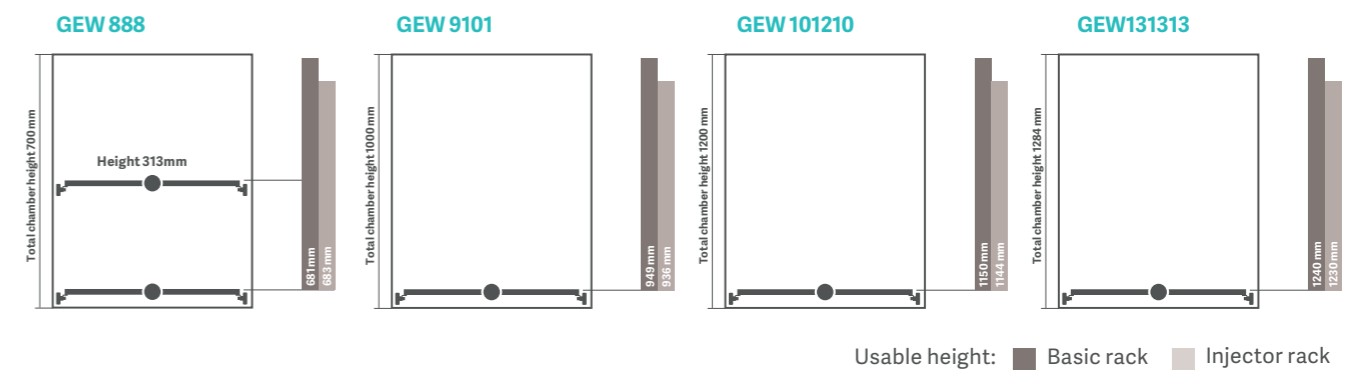

## Usable dimensions on rack

	GEW 888	GEW 9101	GEW 101210	GEW 131313
Injector rack frame inside	705x705 (27.75" x 27.75")	800x800 (31.5" x 31.5")	907x907 (35.7" x 35.7")	1200x1200 (47.24" x 47.24")
Basic rack frame inside	705x705 (27.75" x 27.75")	800x800 (31.5" x 31.5")	907x907 (35.7" x 35.7")	1200x1200 (47.24" x 47.24")



# Standard Racks – Glassware

Injector rack that offer great flexibility, different shapes and sizes can be treated easily and efficiently at the same time.

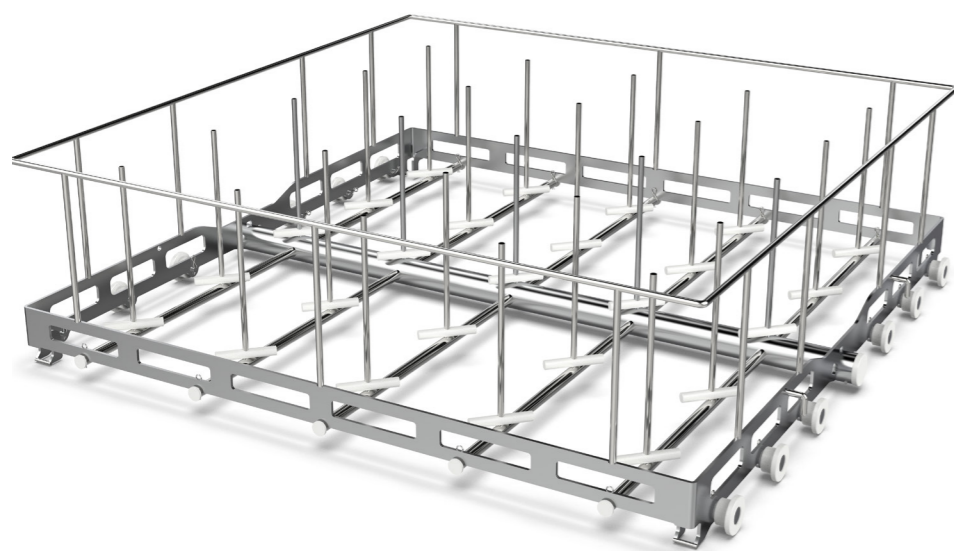

## 1 IXL Injector racks

PTFE holder with one injector including spray ball.  
Application – big volume carboys.

**Model 9109 – Part Number:** 02270005  
**Model 101210 – Part Number:** 02280005  
**Model 131313 – Part Number:** 02260003  
**Model 888 – Part Number:** AA02300010



## 2 IXL Injector racks

2 PTFE holder with one injector including spray ball.  
Application – big volume carboys.

**Model 131313 – Part Number:** 02260004  
Other models available upon request.



## 4 IXL Injector racks

4 PTFE holder with one injector including spray ball.  
Application – big volume carboys.

**Model 888 – Part Number:** AA02300015  
**Model 9109 – Part Number:** 02270006  
**Model 101210 – Part Number:** 02280006  
**Model 131313 – Part Number:** 02260005

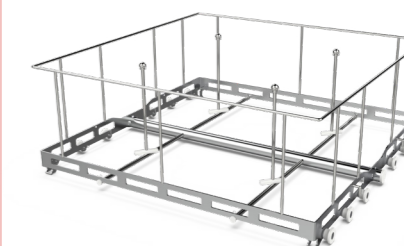

## 5 IXL Injector racks

5 PTFE holder with one injector including spray ball.  
Application – big volume carboys.

**Model 888 – Part Number:** AA02300011  
**Model 9109 – Part Number:** 02270007  
**Model 101210 – Part Number:** 02280006  
**Model 131313 – Part Number:** 02260006



## 9 IXL Injector racks

9 PTFE holder with one injector including spray ball.  
Application – carboys, stainless steel balls, bowls, bottles.

**Model 888 – Part Number:** AA02300016  
**Model 9109 – Part Number:** 02270008  
**Model 101210 – Part Number:** 02280008  
**Model 131313 – Part Number:** 02260007

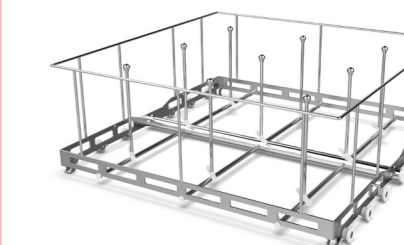

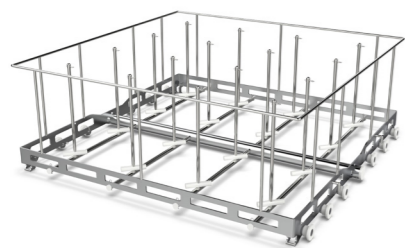

### 16 IXL Injector racks

PFTE holder with injector nozzle.  
Application – carboys, stainless steel balls, bowls, bottles.

**Model 888 – Part Number:** AA02300017

**Model 9109 – Part Number:** 02270009

**Model 101210 – Part Number:** 02280009

**Model 131313 – Part Number:** 02260008



### 25 IXL Injector racks

PFTE holder with injector nozzle.  
Application – carboys, stainless steel balls, bowls, bottles.

**Model 888 – Part Number:** AA02300012

**Model 9109 – Part Number:** 02270010

**Model 101210 – Part Number:** 02280010

**Model 131313 – Part Number:** 02260009



### 36 IXL Injector racks

PFTE holder with injector nozzle.  
Application – carboys, stainless steel balls, bowls, bottles.

**Model 888 – Part Number:** AA02300018

**Model 9109 – Part Number:** 02270011

**Model 101210 – Part Number:** 02280011

**Model 131313 – Part Number:** 02260010



### 49 IXL Injector racks

PFTE holder with injector nozzle.  
Application – carboys, stainless steel balls, bowls, bottles.

**Model 888 – Part Number:** AA02300013

**Model 9109 – Part Number:** 02270012

**Model 101210 – Part Number:** 02280012

**Model 131313 – Part Number:** 02260011

### 64 IXL Injector racks

PFTE holder with injector nozzle.  
Application – small size glassware.

**Model 9109 – Part Number:** 02270013

Other models available upon request.

#### DISTANCE BETWEEN INJECTORS - STANDARD GLASSWARE RACKS

	GEW 888	GEW 9101	GEW 101210	GEW 131313
1 IXL	705mm (27.75")	800mm (31.5")	907mm (35.7")	1200mm (47.24")
2 IXL				700mm (27.55")
4 IXL	352.5mm (13.88")	400mm (15.75")	453.5mm (17.85")	600mm (23.62")
5 IXL	292mm (11.49")	330.5mm (13")	375.5mm (14.78")	497mm (19.57")
9 IXL	235mm (9.25")	266mm (10.47")	301mm (11.85")	400mm (15.75")
16 IXL	176mm (6.93")	200mm (7.87")	225mm (8.86")	300mm (11.81")
25 IXL	141mm (5.55")	160mm (6.3")	179mm (7.05")	240mm (9.45")
36 IXL	117.5mm (4.62")	133mm (5.24")	148.5mm (5.85")	200mm (7.87")
49 IXL	100.5mm (3.96")	114mm (4.49")	130mm (5.12")	171mm (6.73")
64 IXL	88 mm (3.46")	100 mm (3.4")	113 mm (4.45")	

# Custom Racks – Glassware

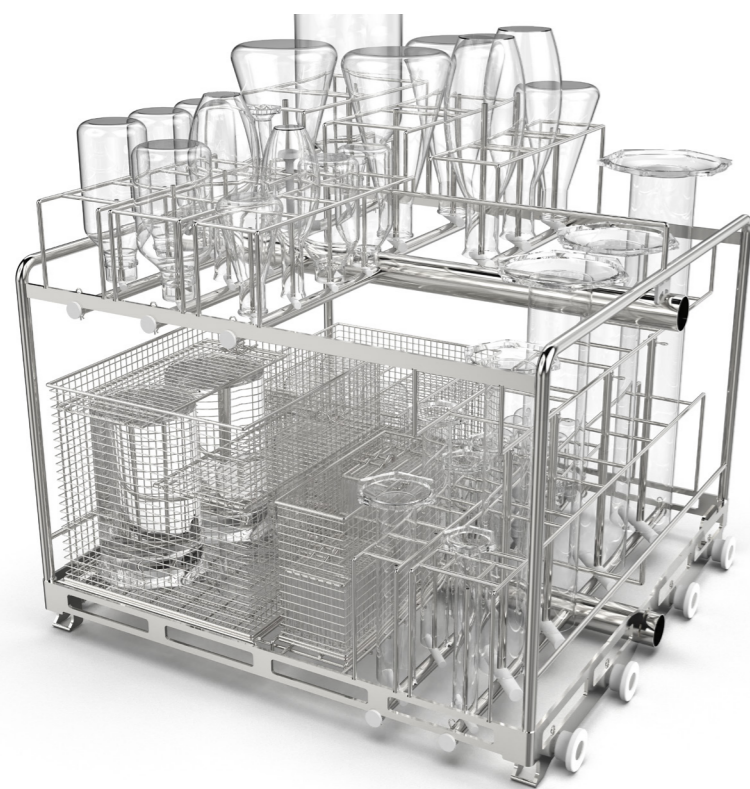

## Custom Rack for glassware

Including empty MTC basket, 3 injectors with spray balls, 12 injectors standard.  
 Customized basket will be adjusted washer chamber dimensions.

**Part Number:** 99702076

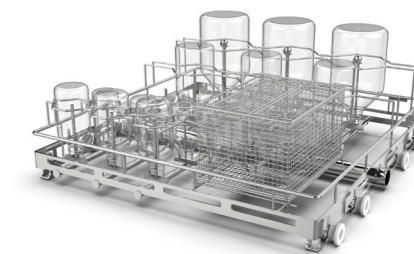

## Custom Rack for glassware

Including empty MTC basket, 5 injectors with spray balls, 11 standard injectors, and 6 perforated angled injectors used for measuring cylinders.

Customized basket will be adjusted washer chamber dimensions.

**Part Number:** 99702083



## Custom 2 level Rack for glassware

Down level: Grid measure 50 x 50, 3 MTC baskets 1/3.  
 Upper level: 31 Injectors with nozzles, 19 standard injectors.

Customized basket will be adjusted washer chamber dimensions.

**Part Number:** 99702168

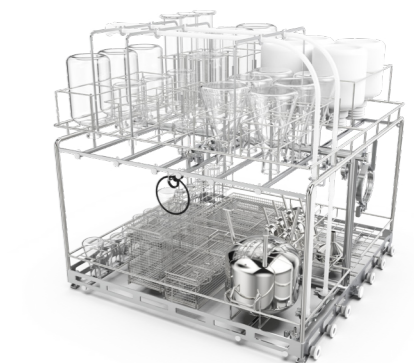

## Custom 2 level Rack for glassware

Down level: mech Grid 50 x 50, 3 MTC baskets + 18 standard injectors  
 Upper level: 18 standard injectors.

Customized basket will be adjusted washer chamber dimensions.

**Part Number:** 99702076





# Custom Racks – Containers

Special designed racks for large volume items.  
Optimal layout and perfect cleaning results.

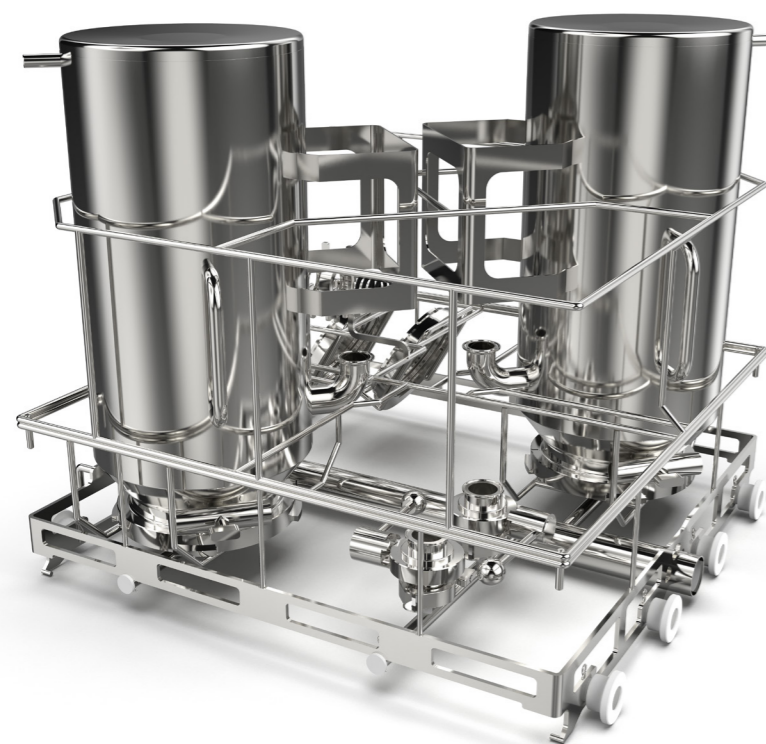

## Special rack for containers and filling line parts

9 injectors, 1 injector with flexible hoses.

**Part Number:** 99701659



## Special rack for 6 carboys

6 injectors with spray ball, two custom MTC baskets with spray arm.

**Part Number:** 99701849



## Custom made bioreactor rack

4 injectors, 2 with spray balls, 2 with clamps and spray arms.

**Part Number:** 99702001



## Special rack for larger containers

4 injectors with spray balls and removable support for stabilizing items in the rack.

**Part Number:** 99702016



## Nalgene rack

4 standard injector with fixed support for stabilizing items in the rack and adjustable cross grid.

**Part Number:** 99702074



# Custom Racks – Hoses

Special designed racks for different hoses

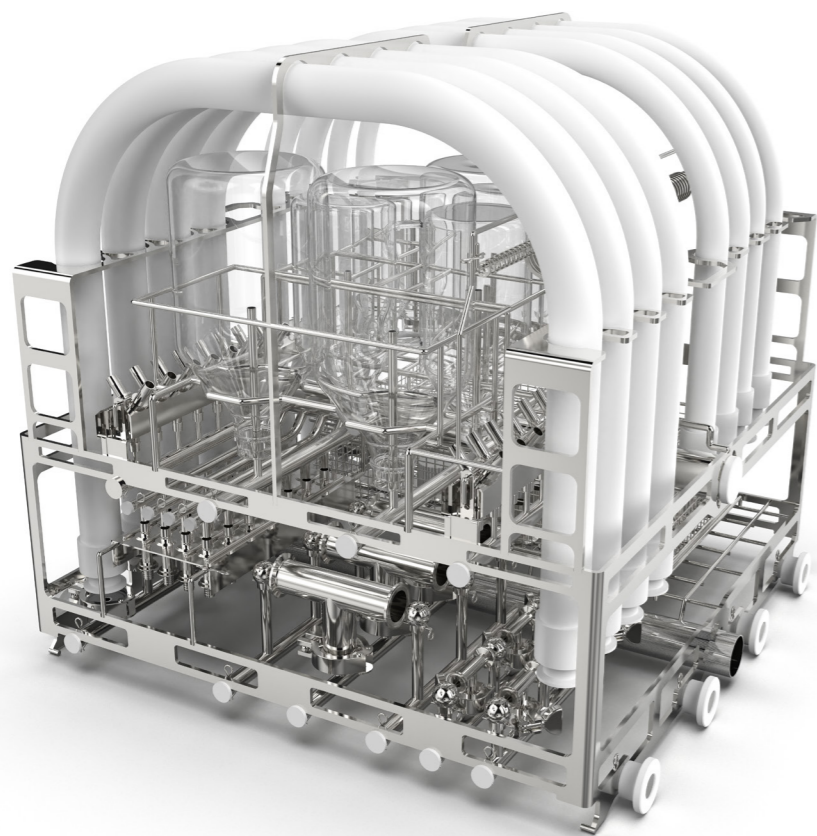

## Special hose rack

Tubes can be inserted to 14 clamp injector connections. 7 clamp injectors for tubes.

Maximal diameter for tubes are 25.4 mm

**Part Number:** 99702167



## Special hose rack

7 clamp connection for optimal water pressure to clean hoses (rewrite).

Maximal diameter for tubes are 25.4 mm

**Part Number:** 99702167

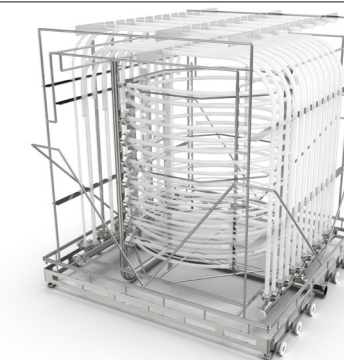

## Special hose rack

5 clamp connections and 6 standard injectors. Including a PPM 80 BASKET.

**Part Number:** 99702153

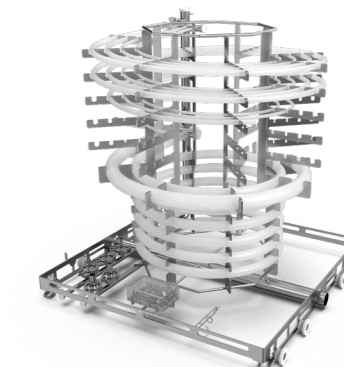

## Special hose rack

Down level: 8 clamp connections, 20 standard injectors and mtc basket mech Grid 50 x 50mm.

Upper level 47 standard injectors with different diameters.

**Part Number:** 99701848

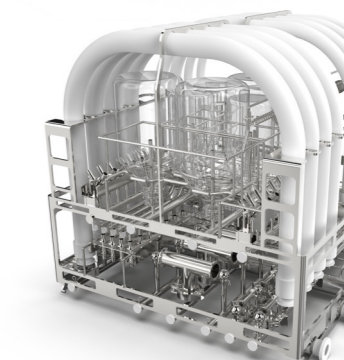

## Special hose rack

15 clamp connection for hoses and 26 standard injectors some with spray ball.

**Part Number:** 99701889





# Custom Racks – Machinery parts

Customized racks for perfect cleaning for complex and in product contacted parts.

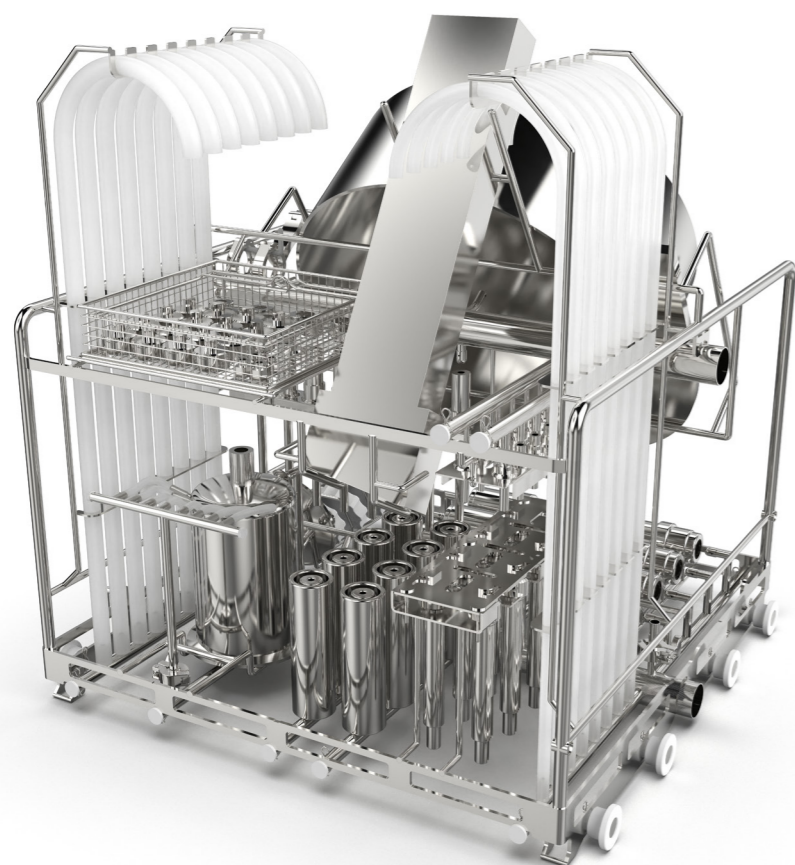

## Filling line rack

Half of the rack comes with mesh grid 50x50 mm + mtc basket  
Other half: 4 injectors with clamps for hoses, 5 standard injectors

**Part Number:** 99702089

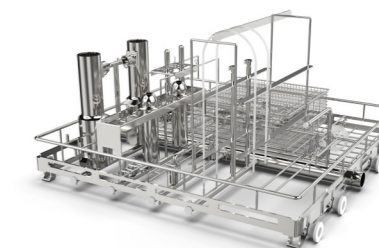

## Filter housing rack

3 clamp injectors and 32 standard injectors some with spray balls and nozzles.

**Part Number:** 99702144



## Filter housing rack

Standard injectors some with spray balls and some with clamps.  
Mech grid below of safety of items. (so they do not fall through - rewrite)

**Part Number:** 99702149

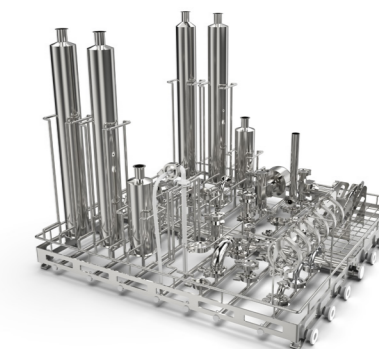

## Filling level rack

Down level: Standard injectors and mtc basket  
Upper level: Standard injector for hoses or needles.

**Part Number:** 99702172

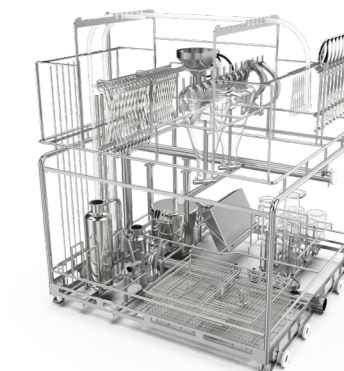

## Filling line rack

78 standard injectors and 25 clamp connection for filter housings.  
Customized mtc basket.

**Part Number:** 99702173

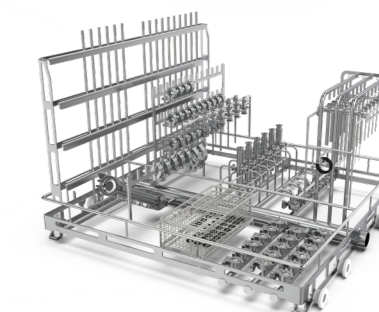



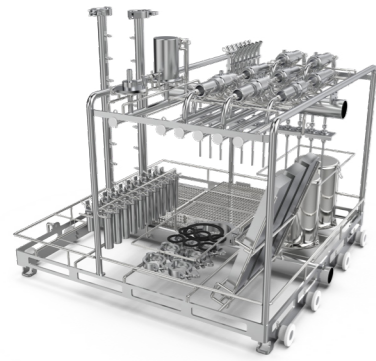

**Filling line rack**

Down level: 1/3 rack mech grid 50x50 mm with 3 small baskets.  
3 injectors with clamps.  
Upper level: 40 standard injectors some with nozzles.

**Part Number:** 99701373

**Various rack**

1 injector with spray ball, 2 injectors with clamps and rotating spray balls.  
Mech grid. Application rack within transfer line.

**Part Number:** 99701892

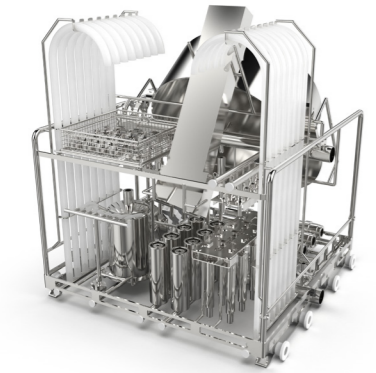
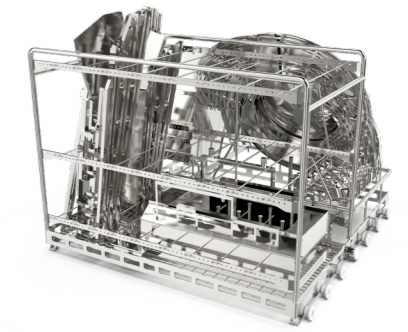

**Filling line rack**

Down level: 40 standard injectors, 2 clamp injector for hoses.  
Upper level: 1 clamp injector, 36 standard injectors some with nozzles and rotating spray ball.

**Part Number:** 99701520

**Various rack**

Customized mtc rack with 34 injectors clamp connection for hoses.  
Application: Hoses and manifolds.

**Part Number:** 99701925

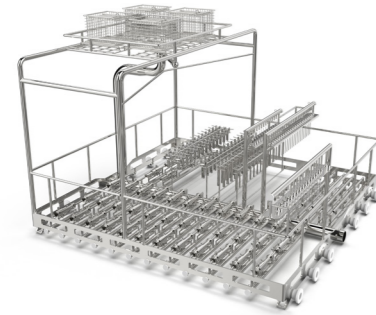
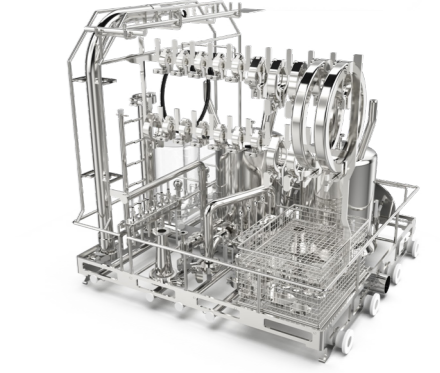

**Filling line rack**

Down level: 94 small injectors  
Upper level 36 standard injectors some with mech grid and spray arms.

**Part Number:** 99701567

**Valve and filter housing rack**

29 standard injectors 1/4 spray arm.

**Part Number:** 99701997

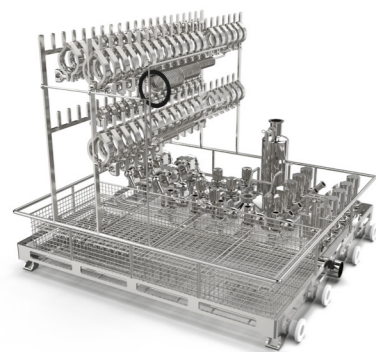
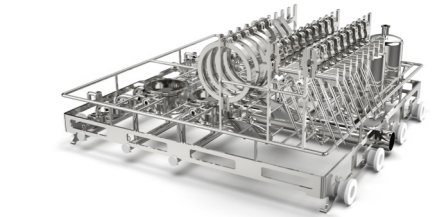

**Fittings and valves rack**

Down level: 1/3 mech grid 50x50 mm, 2/3 customized mtc baskets.  
Upper level: 1/2 rack injectors with nozzles and ptfе connections.

**Part Number:** 99701801

**Cosmetic filling line rack**

1 flexible injector, 2 injectors with clamp connection, 1 small standard injector, 16 standard injectors with spray balls and nozzles.

**Part Number:** 99701999

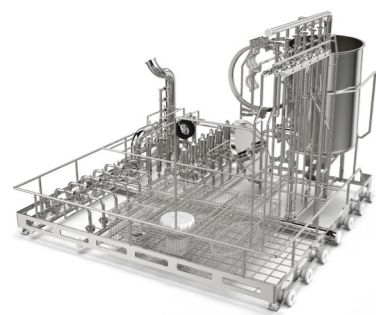
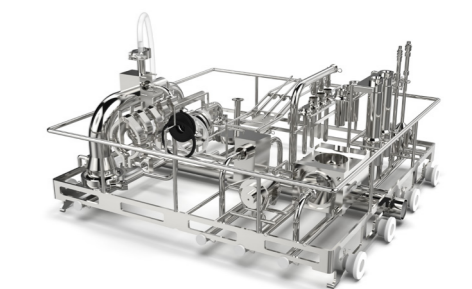

**Filing line rack**

1/3 mesh grid 50x50 mm and 2/3 45 standard injectors some with spray balls and nozzles.

**Part Number:** 99701839

**Special rack for bowls**

Mech grid + 4 standard injectors, 3 injectors with rotating spray ball.

**Part Number:** 99701974

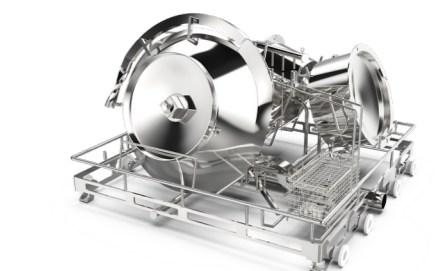

# Accessories

A variety of solutions for cleaning of small parts.



## Mesh basket MTC 1/3 with cover

1/3 mesh basket to be put on a basic rack to be washed without direct injection. Dimensions 162x454x100 mm (6.38" x 17.87" x 3.94")

**Part Number:** 02000018



## Mesh basket MTC

Small mesh basket to be put on a basic rack to be washed without direct injection. Dimensions 162x162x100 mm (6.38" x 6.38" x 3.94")

**Part Number:** 02100017



## Removable adjustable injector grid

**Model GEW 888 Part Number:** AA02300020

**Model GEW 9109 Part Number:** AA02270019

**Model GEW 101210 Part Number:** AA02280022

**Model GEW 131313 Part Number:** AA02260024



## Removable fixed grid for injector rack model 131313

Available for all models upon request.

**Part Number:** 02260013

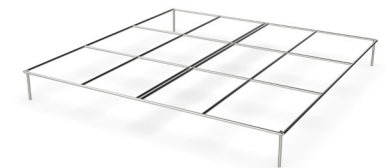

## Removable fixed grid for injector rack model 131313

Available for all models upon request.

**Part Number:** 02260012





# Transfer carts and storage cabinets

Transfer cart allows an easy loading.  
Transfer cart is connected to the machine by docking device.



## 2 Level trolley for model 888

For loading and unloading, multi directional for ease of use.



**TN 888 GMP. Part Number:** AA0230021

## 1 level trolley for all models except (888)

Walk in Trolley for loading and unloading, multi directional for ease of use.



**NB 9109 GMP. Part Number:** AA0227020  
**NB 101210 GMP. Part Number:** AA0228023  
**NB 131313 GMP. Part Number:** AA0226025  
**NB 131820 GMP. Part Number:** 02290002





**Storage cabinet model 9109**

Storage cabinets of 3 empty racks.

**Part Number:** 02270003



**Storage cabinet model 121012**

Storage cabinets of 3 empty racks.

**Part Number:** 02280003



**Storage cabinet model 888**

Storage of 3 racks.

**Part Number:** 02300005



**Storage cabinet model 131313**

One level storage for one rack

**Part Number:** 02260015





With a firm belief that every person and community should have access to the best possible care, Getinge provides hospitals and life science institutions with products and solutions aiming to improve clinical results and optimize workflows. The offering includes products and solutions for intensive care, cardiovascular procedures, operating rooms, sterile reprocessing and life science. Getinge employs over 10,000 people worldwide and the products are sold in more than 135 countries.

Getinge Infection Control AB · PO Box 69 · SE-305 05 Getinge · Sweden · +46 10 335 00 00 · [info@getinge.com](mailto:info@getinge.com)

[www.getinge.com](http://www.getinge.com)