





# TABLE OF CONTENTS

|           |                                    |  |     |
|-----------|------------------------------------|--|-----|
| <b>1</b>  | Introduction                       |  | 5   |
| <b>2</b>  | System Overview                    |  | 15  |
| <b>3</b>  | Operation overview                 |  | 37  |
| <b>4</b>  | Displaying and saving data         |  | 47  |
| <b>5</b>  | Ventilation modes and therapies    |  | 63  |
| <b>6</b>  | Ventilatory settings and functions |  | 107 |
| <b>7</b>  | Alarm handling                     |  | 145 |
| <b>8</b>  | Service & Settings                 |  | 163 |
| <b>9</b>  | Technical data                     |  | 171 |
| <b>10</b> | Index                              |  | 213 |





# 1 Introduction

## Table of contents

|     |                            |  |    |
|-----|----------------------------|--|----|
| 1.1 | Device description         |  | 6  |
| 1.2 | Safety guidelines          |  | 8  |
| 1.3 | Version and Configurations |  | 13 |

## 1.1 Device description

### 1.1.1 Device components

The ventilator system consists of:

1. a user interface for setting ventilation modes and therapies, displaying data and indicating alarms
2. a patient unit for mixing gases and controlling gas delivery
3. a patient circuit for delivering and exchanging gases

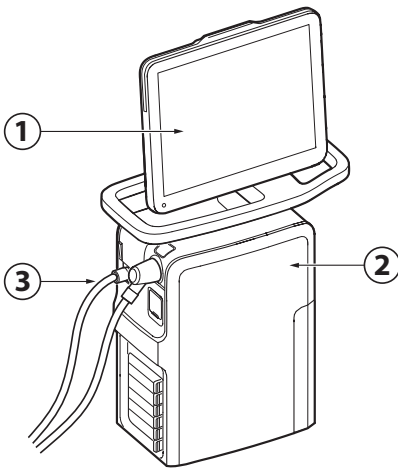

### 1.1.2 Intended use

The SERVO-U ventilator system is:

- intended for respiratory support, monitoring and treatment of neonatal, pediatric and adult patients
- to be used only by healthcare providers
- to be used only in professional healthcare facilities and for transport within these facilities

For NAVA and Edi monitoring, it is in addition intended:

- to provide monitoring of the patient's breathing drive
- to improve synchrony between the ventilator system and patient when the electrical signal from the brain to the diaphragm is active
- for use on all patients with no contraindication for insertion/exchange of a nasogastric tube

### 1.1.3 User's Manual

This manual summarizes the functions and safety features of the ventilator system. It is not all-inclusive and should not be seen as a substitute for training.

#### 1.1.4 Servicing Guidelines

##### CAUTIONS:

- **Regular service:** The ventilator system must be serviced at regular intervals by Maquet authorized personnel who have received specialized training.
- **Complete service records:** All service performed on the ventilator system must be recorded in a service log in accordance with hospital procedures and local and national regulations.
- **Service contract:** It is strongly recommended that all service on the ventilator system should be performed as part of a service contract with Maquet.

**Note:** Modifications of the ventilator system during the actual service life require an evaluation of the requirements of the IEC 60601-1 standard.

### 1.1.5 Disclaimers

#### **Non-professional servicing:**

Maquet has no responsibility for the safe operation of the ventilator system if installation, service or repairs are performed by persons other than Maquet authorized personnel.

## 1.2 Safety guidelines

Follow these safety guidelines. Additional warnings appear in context throughout this document.

Information is highlighted with Warning, Caution, Important or Note, where:

**WARNING!** Indicates critical information about a potential serious outcome to the patient or the user.

**CAUTION:** Indicates instructions that must be followed in order to ensure the proper operation of the equipment.

**Important:** Indicates information intended as help to operate the equipment or its connected devices easily and conveniently.

**Note:** Indicates information requiring special attention.

### 1.2.1 General

#### **WARNINGS!**

- The ventilator system may be operated only by authorized personnel who are properly trained in its use. It must be operated according to the instructions in this User's Manual.
- After unpacking, perform a routine cleaning and a pre-use check.
- Always perform a pre-use check before connecting the ventilator system to a patient.
- Secure all tubing and cables to avoid the risk of unwanted movement of the equipment.
- If any of the following occurs, discontinue use of the ventilator system and contact a service technician:
  - unfamiliar pop-up windows on the screen
  - unfamiliar sounds
  - any unfamiliar or unexplained event
  - alarms that cannot be resolved
- Make sure that a resuscitator is readily available.
- Positive pressure ventilation can be associated with the following adverse events: barotrauma, hypoventilation, hyperventilation or circulatory impairment.
- Ventilation must be started manually when a patient is connected to the ventilator system.
- The inspiratory channel may be contaminated if the safety valve is opened when the patient is coughing.
- Keep the patient unit upright during use.

- Do not cover the ventilator system in any way, since the functioning of the equipment may be adversely affected.
- Do not modify or remove any original parts.
- The ventilator system must not be used during radiotherapy, since this may cause system malfunction.
- The ventilator system must not be used in a hyperbaric chamber.
- The ventilator system must be kept away from magnetic resonance imaging (MRI) equipment.
- When the ventilator system is used with MCare Remote Services, use only network equipment that is safe and complies with the relevant electrical and EMC standards such as IEC 60950.  
**Note:** The network cable is excluded from this requirement.
- Only accessories, supplies, and auxiliary equipment recommended by Maquet should be used with the ventilator system. Use of any other accessories, spare parts or auxiliary equipment may cause degraded system performance and safety.
- Use only the Maquet approved active humidifiers. Use of non-approved active humidifiers may result in higher gas temperatures and increase resistance in filters.
- During humidification, carefully monitor the airway pressure. Increased airway pressure could result from a clogged filter. Replace the filter if the expiratory resistance increases or according to the instructions for the filter, whichever comes first.

- Service, repair and installation may only be performed by Maquet authorized personnel.

#### CAUTIONS:

- Never leave the patient unattended when connected to the ventilator system.
- Before use, make sure the system version displayed under *SYSTEM STATUS/General* corresponds to the system version described in the User's Manual.
- Maquet has no responsibility for the safe operation of the ventilator system if the requirements specified in Intended use on page 6 are not followed.
- When lifting or moving the ventilator system or parts of the system, follow established ergonomic guidelines, ask for assistance, and take appropriate safety precautions. The weight is specified on the ventilator system.
- The expiratory channel and expired gas from the exhaust port may be contaminated.
- If a scavenging system (i.e. gas evacuation) is connected to the ventilator system, it must conform to ISO 80601-2-13 guidelines for subatmospheric pressure and induced flow.
- During operation any water traps must be checked regularly and if necessary emptied.
- All technical documentation is available for use by Maquet authorized personnel.

- When using the MCare Remote Services function, install the network cable so that there is no risk of anyone tripping over it.

- Use an inspiratory filter when ventilating a highly infectious patient.
- All excess fluids must be disposed of according to hospital routines.

**Important:**

- Portable and mobile radio frequency (RF) communications equipment can affect medical electrical equipment.
- The ventilator system must be installed and put into service according to the EMC declaration.
- Securely attach all cables, etc, to minimize the risk of unintentional disconnection.
- While the ventilator system is in use, the wheels of the mobile cart must be locked and the mobile cart must be in a horizontal position.
- When the ventilator system is connected to a patient:
  - Do not lift or disconnect the expiratory cassette.
  - Continuously monitor the settings and measurements displayed on the screen.
- Always use a heat and moisture exchanger (HME) or an active humidifier to prevent dehydration of lung tissue.
- If a heated patient circuit is not used in the system, a water trap must be used on the expiratory tube to avoid condensation in the system when an active humidifier is used. During operation the water traps must be checked regularly and if necessary emptied.

**Notes:**

- In USA, Federal law restricts this device to sale by or on the order of a physician.
- Do not simultaneously touch the patient and any accessible connector contacts.
- Do not solely rely on the use of an external monitor to determine the status of the patient and the ventilator system.
- Extra care should be taken when handling tubes, connectors and other components of the patient circuit. The use of a support arm to relieve the patient from the weight of the tubing system is recommended.
- Contact a Maquet representative regarding decommissioning of the equipment.

## 1.2.2 Power supply

### WARNINGS!

- The power cord must be connected only to an AC mains power outlet with protective earth to avoid the risk of electric shock.
- The power supply cord must be plugged directly into the mains power outlet without the use of any multiple socket outlets. If a multiple socket outlet is used together with other products, total leakage current might be exceeded in the event of a fault in the protective earth.

### CAUTIONS:

- Do NOT use antistatic or electrically conductive tubing with this system.
- Avoid contact with external electrical connector pins.
- Unused module compartments should always contain a dummy module to protect the electrical connector pins from spillage and dust.

**Important:** In case of total loss of power during ventilation, an alarm will sound for 2 minutes. When power is restored, the ventilator system will start in the same state and with the same settings as before the power loss.

### Notes:

- When the system is connected to an external power supply, all connected battery modules are being recharged. This does not affect ventilation.

- Batteries can be added to available slots during operation.

## Battery

### WARNINGS!

- To guarantee reliable battery backup, two fully charged battery modules must be connected at all times.
- Dispose of batteries according to local regulations and not with ordinary waste.

### Important:

- If a battery status message is displayed on the screen, go to *SYSTEM STATUS/Batteries* for detailed information. If no action is taken, the battery operation time may be unreliable.
- Always replace batteries when the ventilator system provides notification of imminent expiration or of diminished operating capacity.
- Do not disconnect and store battery modules over long periods of time because this will degrade their capacity. If battery modules need to be stored for short periods of time (up to one week), then store them fully charged.
- Check battery in *SYSTEM STATUS/Batteries* window to ensure safe battery operation. Always charge the battery before use.
- When not in use, the ventilator system should always be connected to the mains power to ensure fully charged batteries.

### 1.2.3 Fire hazard

#### **WARNINGS!**

- Keep all sources of ignition away from the ventilator system and the oxygen hoses.
- Do not use a ventilator system with worn or frayed gas supply hoses or hoses that have been contaminated by combustible materials such as grease or oil.
- Oxygen-enriched gas is extremely flammable: if a burning odor is detected, disconnect the oxygen supply and mains power and remove the batteries.
- Make sure that both the mains power outlet and the power supply connector are accessible.

### 1.2.4 Gases

**WARNING!** The ventilator system must not be used with helium.

Refer to section Ventilator system on page 175.

### 1.2.5 Auxiliary equipment

#### **CAUTION:**

Measurements of numerical values that have been processed by auxiliary equipment:

- may be inaccurate if equipment not authorized by Maquet is used
- should be disregarded if they conflict with information on the ventilator screen
- must not be used as a substitute for therapeutic or diagnostic decisions.

#### **Note:**

Accessories, supplies, and auxiliary equipment used with the ventilator system should:

- be recommended by Maquet
- meet IEC 60601-1 standards
- meet IEC standards as a whole system



## 1.3 Version and Configurations

This manual applies to version 2.1 of the SERVO-U ventilator system.

The ventilator system has a number of patient categories and ventilation modes available, both for invasive and non invasive ventilation.

The standard configuration includes adult and pediatric patient category, while the neonatal patient category is an option.

### 1.3.1 Available modes and functions

| Modes/Functions            | Patient category |           |       |
|----------------------------|------------------|-----------|-------|
|                            | Neonatal         | Pediatric | Adult |
| PC                         | X                | X         | X     |
| PRVC                       | X                | X         | X     |
| VC                         | —                | X         | X     |
| Bi-Vent/APRV               | X                | X         | X     |
| PS/CPAP                    | X                | X         | X     |
| VS                         | X                | X         | X     |
| NAVA *                     | X                | X         | X     |
| Automode                   |                  |           |       |
| • PC ⇄ PS                  | O                | O         | O     |
| • PRVC ⇄ VS                | O                | O         | O     |
| • VC ⇄ VS                  | —                | O         | O     |
| SIMV                       |                  |           |       |
| • (PC) + PS                | X                | X         | X     |
| • (PRVC) + PS              | X                | X         | X     |
| • (VC) + PS                | —                | X         | X     |
| NIV PC                     | O                | O         | O     |
| NIV PS                     | —                | O         | O     |
| NIV NAVA *                 | O                | O         | O     |
| Nasal CPAP                 | O                | O         | —     |
| High Flow therapy          | O                | O         | O     |
| Y sensor *                 | O                | O         | —     |
| CO <sub>2</sub> analyzer * | O                | O         | O     |
| SERVO COMPASS              | O                | O         | O     |
| Nebulizer                  | X                | X         | X     |
| Alarm output connection    | O                | O         | O     |

\* excluding module

X = standard

— = not applicable

O = option

## 2 System Overview

### Table of contents

|     |                |  |    |
|-----|----------------|--|----|
| 2.1 | Ventilator     |  | 16 |
| 2.2 | Patient unit   |  | 18 |
| 2.3 | User interface |  | 27 |
| 2.4 | Transport      |  | 35 |

## 2.1 Ventilator

The ventilator consists of a user interface and a patient unit.

Air and O<sub>2</sub> may be supplied by a medical pipeline system, a compressor, or by gas cylinders.

Ensure that the patient unit is firmly fixed to the mobile cart via the clamps and locking clamp.

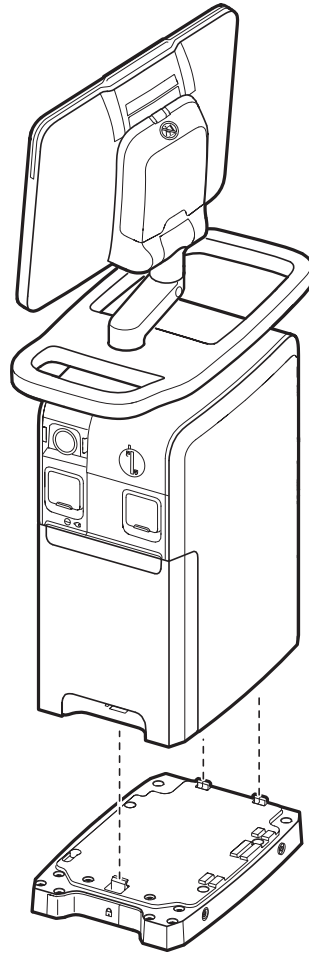

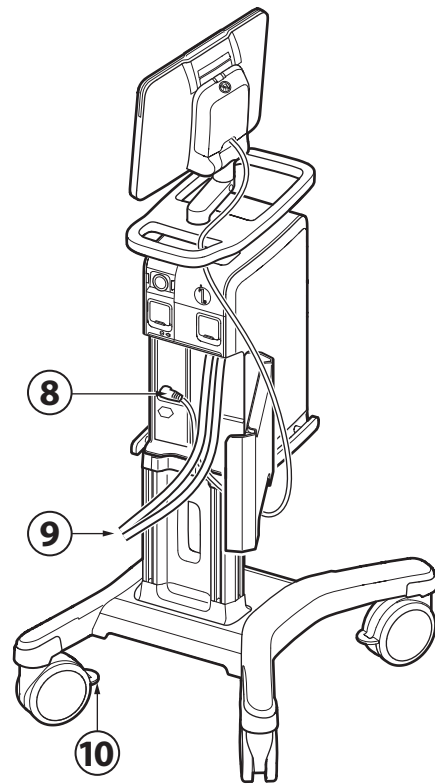
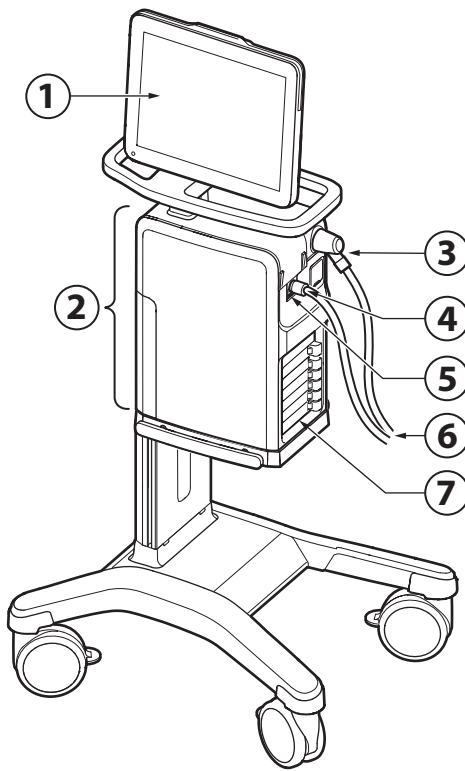

1. User interface
2. Patient unit
3. Expiratory inlet
4. Inspiratory outlet
5. Emergency air intake
6. Patient circuit
7. Module compartment
8. User interface control cable
9. Air and O<sub>2</sub> supply
10. Wheel lock

**WARNING!** For safety reasons, ensure that user interface control cable is securely fastened by tightening the locking nuts on the connectors properly.

**CAUTIONS:**

- The emergency air intake must not be blocked or covered.
- Lock the wheels if the ventilator system is not to be used during transportation.

## 2.2 Patient unit

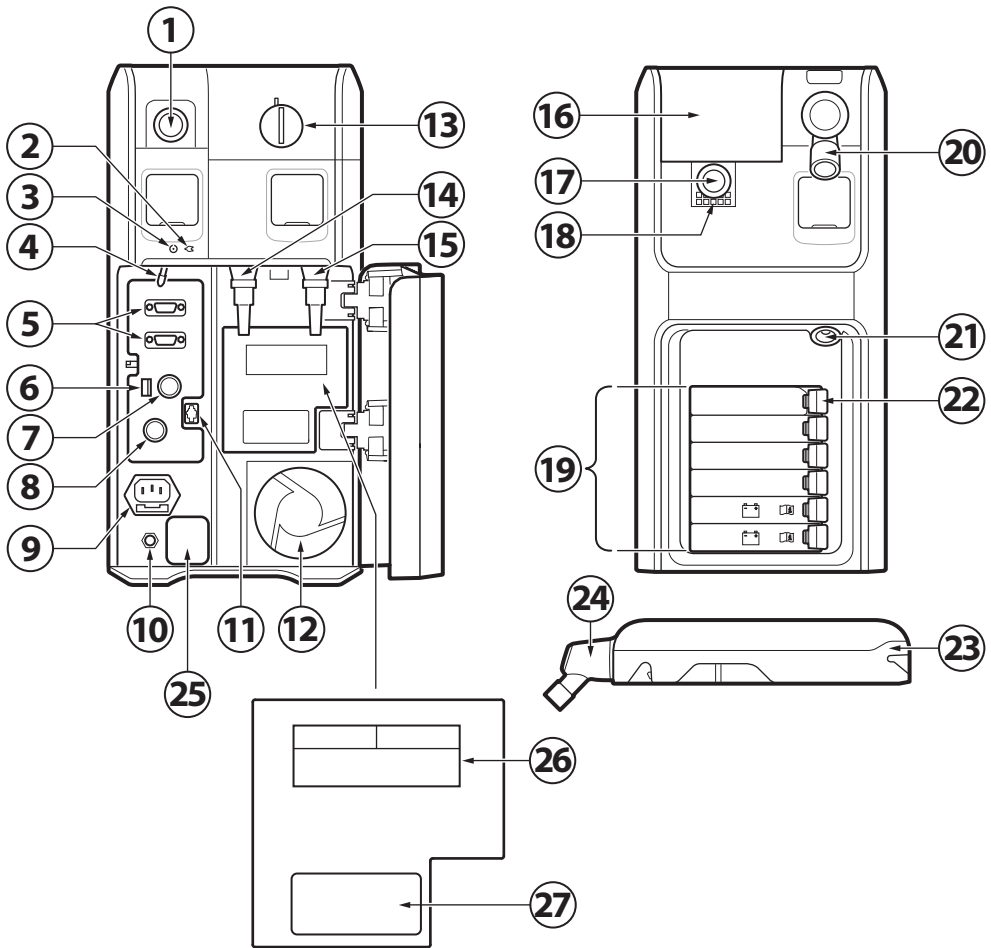

1. Expiratory outlet
2. AC mains power LED, blue
3. Power on LED, green
4. On/Off switch  
The switch must be pulled downwards before it can be switched.
5. RS-232 connectors
6. Fuse for external DC power
7. External +12V DC inlet
8. User interface control cable connector
9. AC mains power source connector with fuse
10. Potential equalization terminal
11. Alarm output connection
12. Cooling fan with filter
13. Lock for inspiratory channel cover
14. Gas inlet for air
15. Gas inlet for O<sub>2</sub>
16. Inspiratory channel cover
17. Inspiratory outlet
18. Emergency air intake
19. Module compartment
20. Expiratory inlet
21. Nebulizer connector
22. Module release levers
23. Expiratory cassette
24. Expiratory inlet with moisture trap
25. Fuse, power label
  - Fuse label
  - AC mains power voltage
  - Potential equalization terminal information
26. Gases and gas inlet pressure label
  - Air
  - O<sub>2</sub>
  - Allowed gas inlet pressures

27. Serial number label

### 2.2.1 Handling modules

Insert a module into the patient unit. Ensure that the module is fully inserted so that the release button returns to a completely closed position.

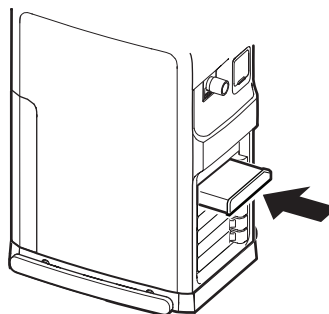





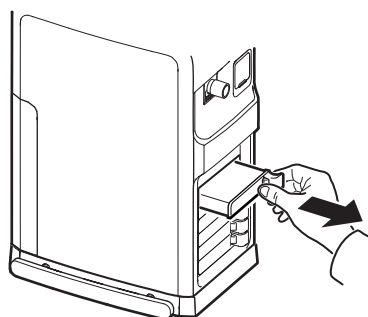

























To remove a module:

- Pull the lever slightly and press the release button while continuing to pull the lever until the module is released from the ventilator system.
- Remove the module from the ventilator system.



## 2.2.2 Symbols on patient unit

| Symbol  | Description   |
|---|---|
|    | CE label—indicates compliance with the requirements of the Medical Device Directive 93/42/EEC |
|    | CSA label—Indicates compliance with Canadian and US standards                                 |
|    | Type B—indicates classification according to IEC 60601-1                                      |
|    | Type BF applied part — indicates classification according to IEC 60601-1                      |
|    | Potential equalization terminal   |
|    | Nebulizer connector   |
|    | RS232/Serial port - connector for data communication  |
|    | Ingress protection, IP21  |
|    | User interface connector  |
|    | Fuse for external 12V DC  |
|   | External 12V DC input   |
|  | Battery   |
|  | Expiratory gas flow from the patient  |
|  | Inpiratory gas flow to patient  |
|  | Mains power On/Off  |
|  | Mains connected, batteries charging   |
|  | Gas exhaust port—exhaust gas flow from ventilator system                                      |
|  | Alarm output connection   |
|  | Special waste   |
|  | Caution   |
|  | Consult instructions for use  |

| Symbol  | Description  |
|---|--|
|  | Consult accompanying documentation   |
|  | Press to close/open  |
|  | Lock   |
|  | Unlock   |
|  | Serial number  |
|  | Order number   |
|  | Weight of patient unit with user interface and ventilator including its safe working load. |
|  | UDI Label - Unique Device Identification. See technical specifications, page 208.          |
|  | MR Unsafe - keep away from magnetic resonance imaging (MRI) equipment.                     |



**Notes:**

- **Special waste.** This product contains electronic and electrical components. Discard disposable, replaced and left-over parts in accordance with appropriate industrial and environmental standards.
- **Potential equalization terminal.** The potential equalization terminal is designed for the connection of a potential equalization conductor according to DIN 42 801 and IEC 60601-1. The function of the potential equalization terminal is to equalize potentials between the ventilator system and other medical devices that can be touched simultaneously. The potential equalization terminal must not be used for a protective earth connection.

### 2.2.3 Gas flow through the Patient unit

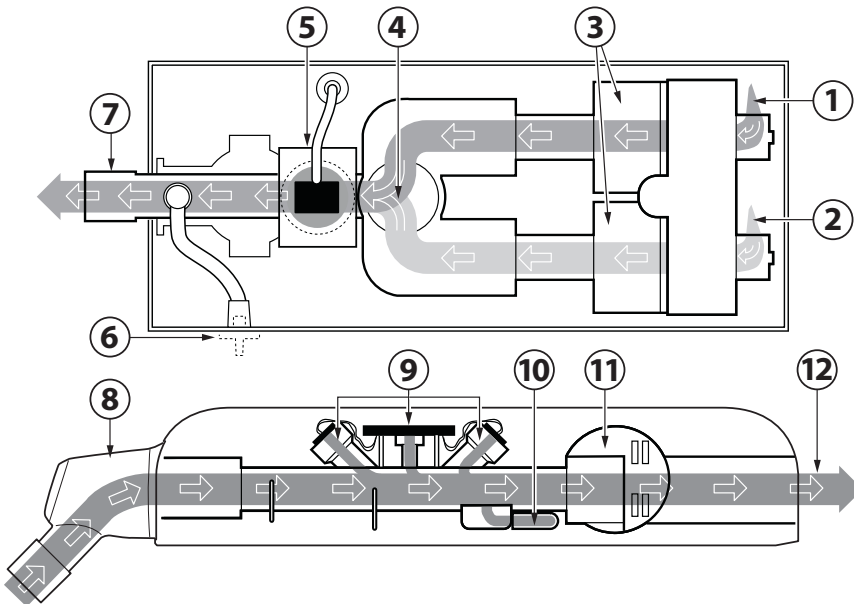

1. Gas inlet for O<sub>2</sub>
2. Gas inlet for air
3. The gas flow is regulated by the gas modules for air and O<sub>2</sub>.
4. The gases are mixed in the inspiratory mixing section.
5. The oxygen concentration can be measured with an O<sub>2</sub> sensor or an O<sub>2</sub> cell. The O<sub>2</sub> cell is protected by a bacterial/viral filter.
6. The pressure of the mixed gas delivered to the patient is measured by the inspiratory pressure transducer. The transducer is protected by a bacterial filter.
7. The inspiratory channel delivers the mixed gas to the patient circuit inspiratory tubing and contains a safety valve.
8. Expiratory inlet, which contains a moisture trap.
9. The gas flow through the expiratory channel is measured by ultrasonic transducers.
10. The pressure of the gas delivered to the patient is measured by the expiratory pressure transducer. The transducer is protected by a bacterial filter.
11. The expiratory valve regulates the pressure in the patient circuit.
12. The gas flow from the patient circuit leaves the ventilator system via the exhaust port.

**Note:** The expiratory cassette can be exchanged between different ventilator systems. Always perform a pre-use check after exchanging an expiratory cassette.

## 2.2.4 Patient circuit

Refer to System Flow Chart, Ventilation, Patient Connection for information regarding patient circuit configurations to be used with the ventilator system.

### 15 - 22 mm Ø patient circuit, reusable

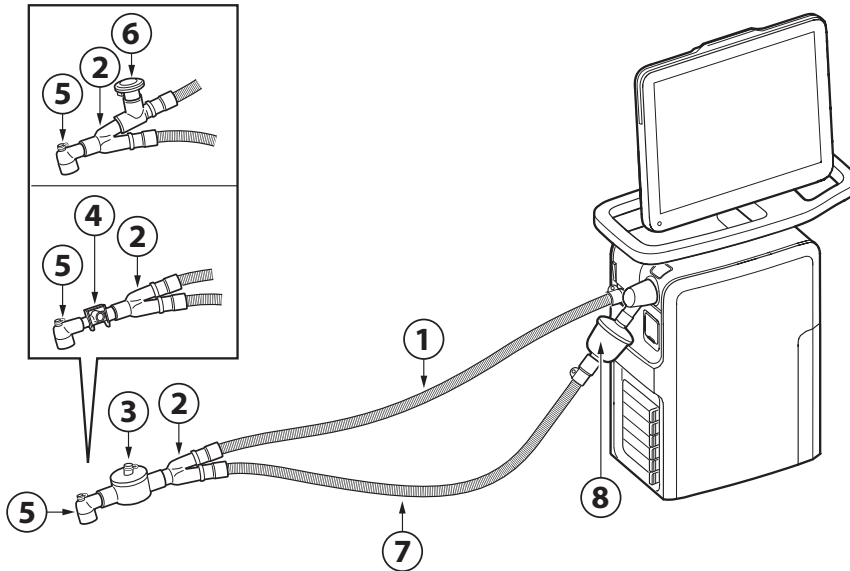

1. Inspiratory patient tube
2. Y piece
3. Heat and moisture exchanger (HME)
4. CO<sub>2</sub> airway adapter
5. Angled adapter for endotracheal tube
6. Aerogen Pro
7. Expiratory patient tube
8. Expiratory filter

#### Notes:

- HME disconnection is mandatory during nebulization.
- Expiratory filter connection is mandatory during nebulization.

## 22 mm Ø patient circuit, dual heat disposable

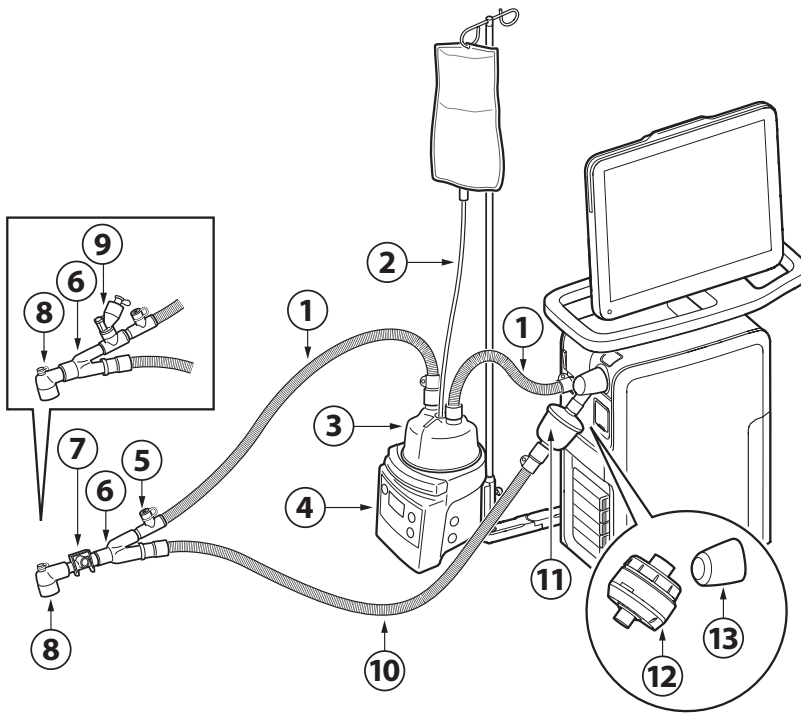

1. Inspiratory patient tube
2. Water autofill
3. Humidification chamber
4. Active humidifier
5. Cuff with temperature port
6. Y piece
7. CO<sub>2</sub> airway adapter
8. Angled adapter for endotracheal tube
9. Aerogen Solo
10. Expiratory patient tube
11. Expiratory filter
12. Expiratory heater Servo Duo Guard
13. Thermoshell, expiratory cassette

### Notes:

- Turn off the active humidifier during nebulization.
- Expiratory filter connection is mandatory during nebulization.
- Thermoshell, expiratory cassette must be used when using heated expiratory tubing or Expiratory heater Servo Duo Guard.

## 10 mm Ø patient circuit, single heat reusable

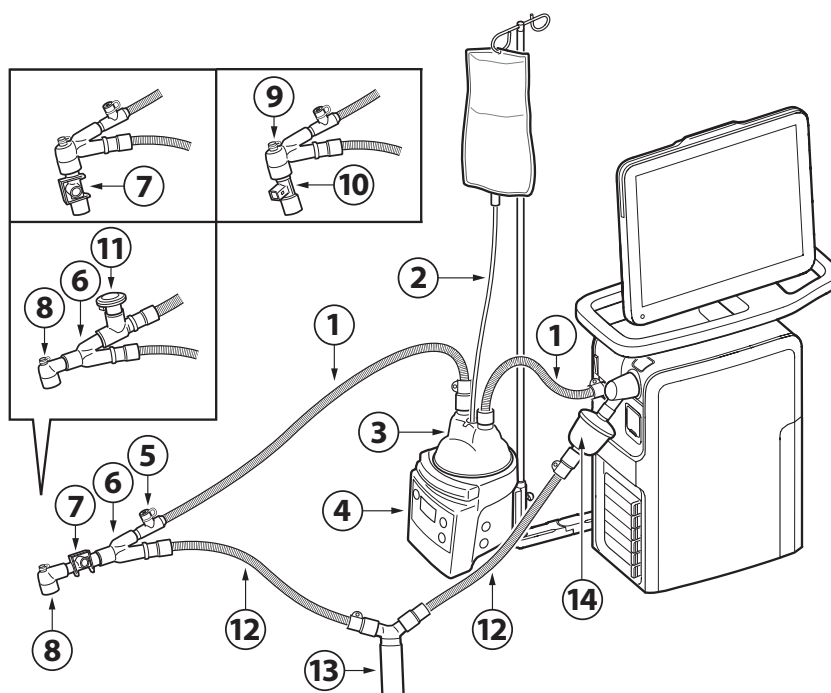

1. Inspiratory patient tube
2. Water autofill
3. Humidification chamber
4. Active humidifier
5. Cuff with temperature port
6. Y piece
7. CO<sub>2</sub> airway adapter
8. Angled adapter for endotracheal tube
9. Pressure line connection port
10. Y sensor
11. Aerogen Pro
12. Expiratory patient tube
13. Water trap
14. Expiratory filter

### Notes:

- Turn off the active humidifier during nebulization.
- Expiratory filter connection is mandatory during nebulization.
- A water trap is recommended if a single heated patient circuit is used.

## 10 mm Ø patient circuit, dual heat disposable

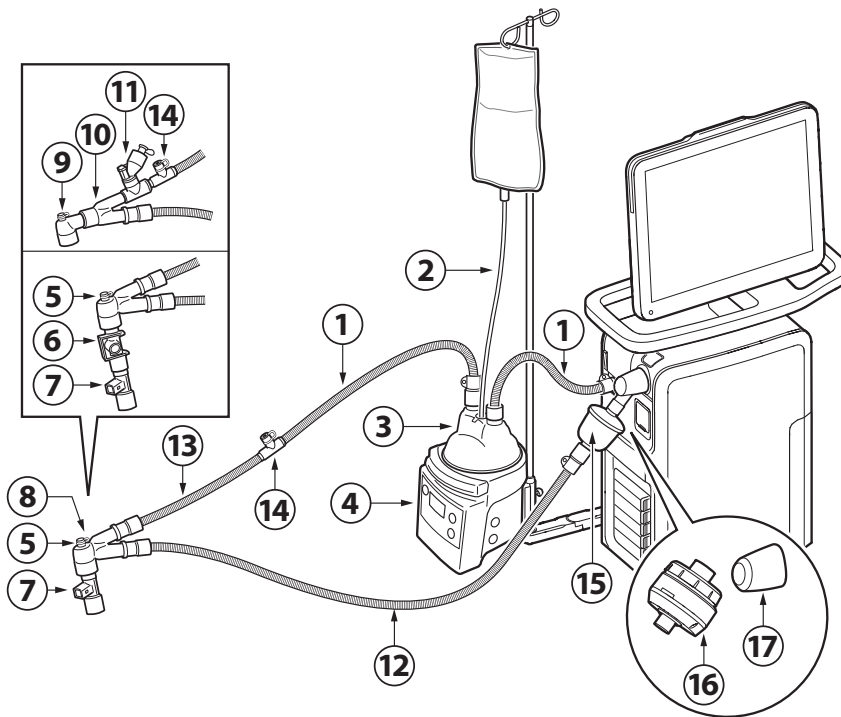

1. Inspiratory patient tube
2. Water autofill
3. Humidification chamber
4. Active humidifier
5. Angled Y piece
6. CO<sub>2</sub> airway adapter
7. Y sensor
8. Pressure line connection port
9. Angled adapter for endotracheal tube
10. Y piece
11. Aerogen Solo
12. Expiratory patient tube
13. Extension tube for incubator use
14. Cuff with temperature port
15. Expiratory filter
16. Expiratory heater Servo Duo Guard
17. Thermoshell, expiratory cassette

### Notes:

- Turn off the active humidifier during nebulization.
- Expiratory filter connection is mandatory during nebulization.
- Thermoshell, expiratory cassette must be used when using heated expiratory tubing or Expiratory heater Servo Duo Guard.

## 2.3 User interface

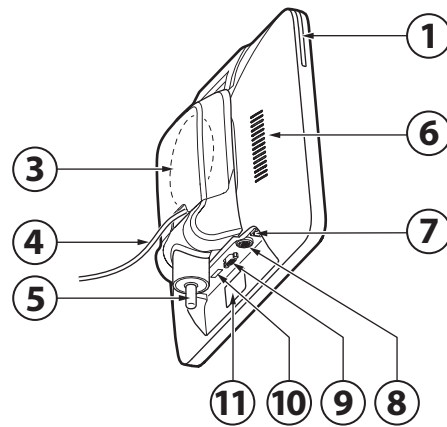
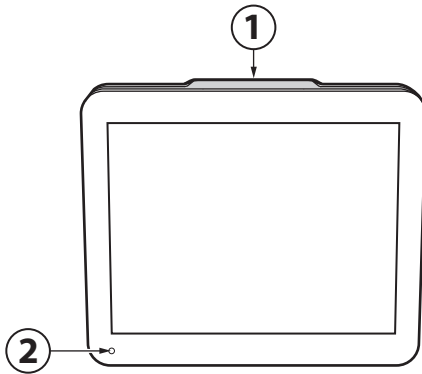

1. Alarm indicator, light frame
2. Ambient light sensor for automatic adjustment of screen brightness
3. Cable reel for the user interface control cable
4. Control cable (2.9 m long)
5. User interface stand
6. Loudspeaker
7. Network cable port
8. User interface control cable port
9. VGA port
10. USB port
11. Serial number label

**WARNING!** For safety reasons, ensure that user interface control cable is securely fastened by tightening the locking nuts on the connectors properly.

**CAUTION:** External monitors or similar devices connected to the VGA port of the system must be powered via a medical grade isolation transformer. No other use is allowed.

**Important:** Only a USB memory stick may be connected to the USB port.

### 2.3.1 Interactive Areas of the user interface

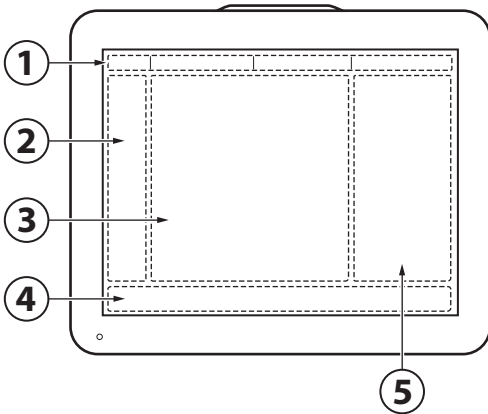

The user interface is completely touch based and is divided into the following areas:

1. Status bar
2. Quick menu/extended menu
3. Display area
4. Direct access bar
5. Numerical values

**Important:**

- Do not use sharp tools on the screen.
- Fluid on the screen can disturb touch functionality.

### 2.3.2 Navigating the User Interface

To navigate the user interface, adjust settings and get support:

- Tap
- Tap and hold
- Scroll vertically or horizontally
- Drag and drop

### 2.3.3 User support

The user is supported by the following:

- Alarm management
- Safety scales
- Dynamic images
- Information texts
- Pre-use check instructions
- Shortcuts
- Prompts

**Note:**

The following colors are used for settings:

- Red — not recommended
- Yellow — use with caution
- Green — normal

### Alarm management

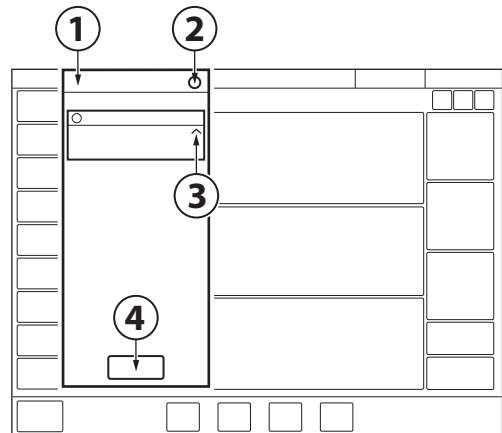

1. Alarm list
2. Number of active alarms
3. Alarm management checklist
4. Alarm history

Refer to chapter Alarm handling on page 145.



## Safety scales

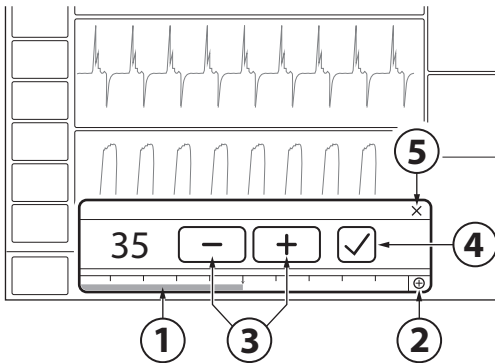

1. Slide bar
2. Full settings range
3. Increase/decrease setting
4. Accept
5. Cancel

Refer to section Safety scales on page 42.

## Dynamic images

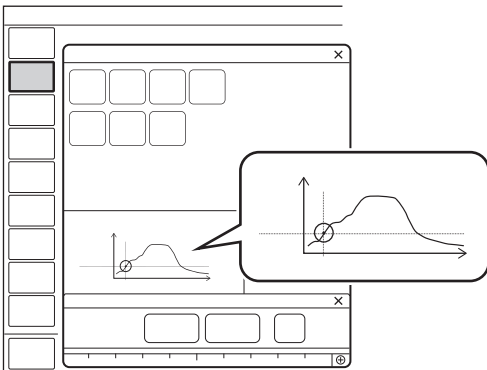

The dynamic image illustrates the effects of the changes made to selected ventilation settings.

## Information texts

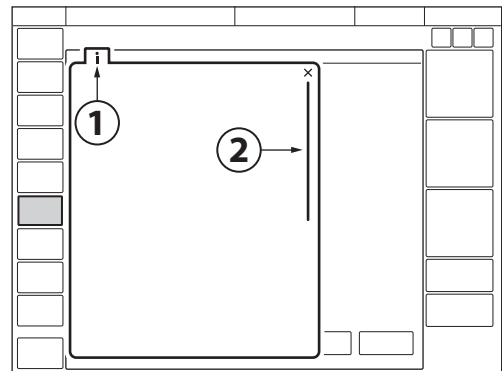

1. Information text is available.
2. Indication that more information is available by scrolling vertically in the middle of the information window.

## Pre-Use Check instructions

Refer to section Pre-use check on page 38.

## Shortcuts

Some frequently used functions can be accessed via a shortcut. There are shortcuts to the following windows:

- Alarm limits
- Patient data
- Battery status
- Leakage compensation deactivation
- Circuit compensation deactivation
- Edi catheter positioning
- Y sensor status
- Nebulization shortcut

## Prompts

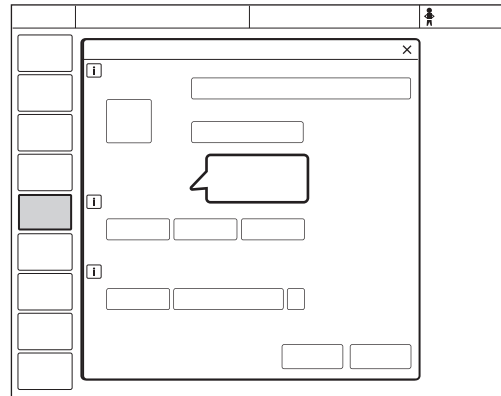

Prompts indicate that input is required.

### 2.3.4 Symbols on User Interface

| Symbol | Description   |
|--------|---|
|        | Extended menu/quick menu toggle                                 |
|        | Extended menu show/extended menu hide                           |
|        | Start ventilation   |
|        | Stop ventilation/Standby  |
|        | Alarm limits/Alarm limits shortcut                              |
|        | Audio pause   |
|        | Audio paused  |
|        | Audio off   |
|        | Audio pause - all alarms, active and inactive are pre-silenced. |
|        | Alarm on  |
|        | Alarm off   |
|        | Check alarms  |
|        | Alarm sound level   |
|        | Adult/patient data shortcut                                     |
|        | Pediatric/patient data shortcut                                 |
|        | Neonatal/patient data shortcut                                  |
|        | AC mains power  |
|        | Battery capacity/Battery status shortcut                        |
|        | External 12V DC power   |
|        | Backup on   |
|        | Backup off  |
|        | Reference marking, CO <sub>2</sub> calibration                  |
|        | Zero marking, CO <sub>2</sub> calibration                       |

| Symbol | Description   |
|--------|---|
|        | Edi catheter positioning arrows                                     |
|        | Edi catheter positioning shortcut                                   |
|        | Circuit compensation on/Circuit compensation deactivation shortcut  |
|        | Circuit compensation off  |
|        | Invasive ventilation adult  |
|        | Invasive ventilation neonatal/pediatric                             |
|        | Non invasive ventilation adult                                      |
|        | Non invasive ventilation neonatal/pediatric                         |
|        | High Flow therapy   |
|        | Leakage compensation on/ Leakage compensation deactivation shortcut |
|        | Leakage compensation off  |
|        | Two overlay loops on  |
|        | Two overlay loops off   |
|        | Reference loop on   |
|        | Reference loop off  |
|        | Loop grid on  |
|        | Loop grid off   |
|        | SERVO COMPASS on  |

| Symbol | Description                                   |
|--------|---|
|        | SERVO COMPASS off                             |
|        | SERVO COMPASS reference measurement on        |
|        | SERVO COMPASS reference measurement off       |
|        | Calibration & tests                           |
|        | Compensation                                  |
|        | Configuration                                 |
|        | NAVA  |
|        | Maneuvers                                     |
|        | Media   |
|        | Modes   |
|        | Patient data                                  |
|        | System status                                 |
|        | Trends & logs                                 |
|        | Views   |
|        | Screen layout                                 |
|        | Disconnection/Suction                         |
|        | Service & Settings                            |
|        | Biomed  |
|        | Service                                       |
|        | Remote services                               |
|        | Exit  |
|        | Nebulization period/Nebulization shortcut     |
|        | Continuous nebulization/Nebulization shortcut |
|        | O <sub>2</sub> boost locked to 100 %          |

















| Symbol | Description   |
|--------|---|
|        | Y sensor measuring enabled/Y sensor status shortcut |
|        | Y sensor measuring disabled                         |
|        | Edi trigger   |
|        | Pneumatic trigger, pressure/flow                    |
|        | Organize  |
|        | Panel locked  |
|        | Panel unlocked                                      |
|        | Progress  |
|        | Extended settings range                             |
|        | Normal settings range                               |
|        | Recorder  |
|        | Recording waveforms 30 seconds                      |
|        | Recording waveforms in progress                     |
|        | Camera for taking screenshots                       |
|        | Freeze ECG  |
|        | Value not within range                              |
|        | Uncertain value                                     |
|        | Test failed (red)                                   |
|        | Test not performed (yellow)                         |
|        | Test passed (green)                                 |
|        | Accept  |
|        | Decrease  |
|        | Increase  |
|        | Information text                                    |
|        | Cancel (red)<br>Close (green)                       |

| Symbol | Description   |
|--------|---|
|        | Switch between main/backup modes                                      |
|        | Volume Control with flow adaptation                                   |
|        | Volume Control without flow adaptation                                |
|        | Additional values & settings hide/Additional values & settings show   |
|        | Do not push the user interface as the ventilator system may tip over. |
|        | Consult instructions for use  |
|        | User interface connector  |
|        | Network connection  |
|        | USB connection  |
|        | VGA connection  |
|        | Serial number   |
|        | Manufacturing number  |
|        | Order number  |
|        | Warning   |
|        | Special waste   |

**Note: Special waste.** This product contains electronic and electrical components. Discard disposable, replaced and left-over parts in accordance with appropriate industrial and environmental standards.

### 2.3.5 Symbols on accessories and packaging

| Symbol     | Explanation   |
|------------|---|
|            | CE label—indicates compliance with the requirements of the Medical Device Directive 93/42/EEC                           |
| 0123       |   |
|            | Order number  |
|            | Number to identify the production batch   |
| <b>QTY</b> | Quantity  |
|            | Outer diameter in mm  |
|            | Inner diameter in mm  |
|            | Indicates the inner diameter of the endotracheal tube   |
| Fr/cm      | Circumference/length  |
|            | Use by date   |
|            | Do not re-use. Single use only.   |
|            | Do not use if packaging is damaged  |
|            | Consult accompanying documentation  |
|            | Keep away from sunlight   |
|            | Method of sterilization using irradiation   |
|            | Manufacturer  |
|            | Manufacturing date  |
|            | In USA, Federal law restricts this device to sale by or on the order of a physician.                                    |
|            | Recyclable material. Recycling must be performed in accordance with appropriate industrial and environmental standards. |
|            | Special waste to be disposed of in accordance with appropriate industrial and environmental standards                   |
| <b>Pb</b>  |   |

| Symbol  | Explanation   |
|---|---|
|    | Gas cylinder  |
|    | Defibrillation proof Type CF applied part - indicates classification according to IEC 60601-1 |
|    | Type BF applied part — indicates classification according to IEC 60601-1                      |
|    | Type B—indicates classification according to IEC 60601-1                                      |
|    | Humidity limitation   |
|    | Temperature limitation  |
|    | Fragile — handle with care  |
|    | Keep away from water  |
|    | This way up — indicates correct upright position of the transport package                     |
|  | Atmospheric pressure limitation   |
|  | Do not expose to heat or fire.  |
|  | Do not expose to mechanical force.  |
|  | Do not dismantle, open or shred.  |
|  | The support arm must be folded during transport.  |
|  | Lock  |
|  | Unlock  |

| Symbol  | Explanation                  |
|---|------------------------------|
|  | Consult instructions for use |

## 2.4 Transport

### 2.4.1 Before Intrahospital transport

Before transporting the ventilator system with or without a patient connected, follow facility guidelines and:

- Be sure that the patient unit and the user interface are securely attached and locked.
- Be sure that all accessories such as modules, gas cylinders, and humidifier are securely attached and locked.
- Be sure that the gas cylinders are connected and have sufficient gas.
- Be sure that the straps are firmly wrapped across the center of the gas cylinders so that the cylinders do not move during transport.
- Be sure that the batteries are fully charged.

**Important:** At least two batteries must be connected during transport.

- Inspect the resuscitator.
- Inspect the mobile cart for damage.
- Be sure that the support arm is folded before transport.

### 2.4.2 During Intrahospital transport

While transporting the ventilator system with or without a patient connected, follow facility guidelines and:

- Use the handles on the mobile cart.
- Transport the bed and the ventilator system slowly, and watch the patient connection carefully to see that no pulling or other movement occurs.
- If triggering problems occur during intrahospital transport because of extreme vibrations then Pressure Control mode is recommended.
- Be careful not to tip the mobile cart when crossing an obstacle like a threshold.
- On arrival, connect the ventilator system to mains power.

**CAUTION:** Do not load the ventilator equipment asymmetrically on the ventilator system to avoid instability.





## 3 Operation overview

### Table of contents

|      |                         |  |    |
|------|-------------------------|--|----|
| 3.1  | Workflow summary        |  | 38 |
| 3.2  | Pre-use check           |  | 38 |
| 3.3  | Patient circuit test    |  | 40 |
| 3.4  | Calibration & tests     |  | 40 |
| 3.5  | Select patient category |  | 41 |
| 3.6  | Select ventilation type |  | 41 |
| 3.7  | Set ventilation mode    |  | 42 |
| 3.8  | Set alarm limits        |  | 43 |
| 3.9  | Enter patient data      |  | 45 |
| 3.10 | Start ventilation       |  | 45 |
| 3.11 | Stop ventilation        |  | 45 |

### 3.1 Workflow summary

- Turn on the ventilator system, prepare the patient circuit to be used and perform a pre-use check.
- Select patient category.
- Select invasive or non invasive ventilation.
- Set the ventilation mode or therapy.
- Check, and if necessary, adjust the alarm limits.
- Enter data for the new patient, including height, weight, and gender (optional).
- Start ventilation and connect ventilator system to patient.
- Adjust alarm limits if necessary.

Stop ventilation, when desired.

### 3.2 Pre-use check

The pre-use check contains a number of tests that the ventilator system automatically performs.

Refer to section Pre-use check tests on page 183.

Each test starts automatically when the previous test is completed.

To ensure correct system functionality, optimal performance and patient safety, a pre-use check must be performed.

#### **WARNINGS!**

- Always perform a pre-use check before connecting the ventilator system to a patient.
- Do not connect the ventilator system to a patient while a malfunction persists.

**Important:**

- When the pre-use check is completed, all sources of alarm signals and alarm conditions have been verified and the alarm system operates correctly.
- The volume of the patient circuit used during pre-use check should be the same as during ventilation.

If the patient circuit is changed after the pre-use check is completed, perform a new pre-use check or a patient circuit test.

- Do not disconnect the expiratory cassette while the ventilator system is in operation; if necessary, disconnect the cassette while in *STANDBY*.

Malfunctions detected during the start-up procedure.

Refer to section System messages on page 153 for more information.

**3.2.1 Start pre-use check**

- Connect the ventilator system to a mains power outlet.

**Note:** Ensure that the user interface control cable is never disconnected while the ventilator system is powered on.

- Connect the ventilator system to gas supplies.
- Turn the ventilator system on. Refer to section Patient unit on page 18.
- Tap *PRE-USE CHECK* in *STANDBY*.
- Tap *Yes* in the *PRE-USE CHECK* window to start, and follow on-screen instructions.

**3.2.2 Complete pre-use check**

A symbol and a color marking appear on screen for each pre-use check test, as appropriate: *Passed*, *Failed* and *Not performed*.

- Tap *OK* to confirm or tap *Redo test* to restart the pre-use check.

The ventilator system returns to *STANDBY* when the pre-use check is completed.

**Notes:**

- The status of the two latest pre-use checks and patient circuit tests is displayed under *SYSTEM STATUS/General*.
- The status of the latest pre-use check and patient circuit test is also displayed in *STANDBY*.

### 3.3 Patient circuit test

In Standby, the patient circuit test may be performed separately from the pre-use check.

**CAUTION:** The patient circuit test must be performed with a complete patient circuit, including all accessories (e.g. active humidifier filled with water, filter, CO<sub>2</sub> analyzer, Y sensor and nebulizer), that is to be used with the patient.

The patient circuit test measures resistance and compliance in the patient circuit. If the patient circuit is changed and no new patient circuit test is performed, the ventilator will compensate incorrectly based on the measurements of the previous patient circuit.

If the correct circuit is not tested, the following risks may arise:

- In volume-based modes, the volume delivered to the patient will be incorrect.
- In pressure-based modes, the volume measured will be incorrect.

Tap *PATIENT CIRCUIT TEST* and follow on-screen instructions.

The result from the patient circuit test is displayed in *PATIENT CIRCUIT TEST* in *STANDBY*. Detailed result are displayed in the *SYSTEM STATUS/General* window.

**Important:** The patient circuit test does not replace the pre-use check.

### 3.4 Calibration & tests

The following calibration and test procedures should be performed as appropriate:

- **Edi module test**  
Refer to section *Edi module test* on page 84.
- **CO<sub>2</sub> analyzer calibration and adjustment**  
Refer to section *CO<sub>2</sub> analyzer calibration* on page 137.
- **Y sensor calibration**  
Refer to section *Y sensor calibration* on page 142.
- **O<sub>2</sub> cell adjustment**  
Refer to section *Adjust the O<sub>2</sub> cell* on page 143.

## 3.5 Select patient category

- Tap patient category in *STANDBY*. All available patient categories appear.
- Select the appropriate patient category. The patient data shortcut in the status bar changes accordingly.

**Important:** Always check the alarm settings after changing the patient category.

### Notes:

- Changing the patient category affects the following settings:
  - default values for alarm limits
  - allowed ranges for alarm limits
  - default values for ventilatory settings
  - allowed ranges for ventilatory settings
  - pressure and flow regulation
  - scaling
- The default values may have been changed by a previous user.

### 3.5.1 Change patient category

To change the patient category during ventilation:

- Tap the patient data shortcut in the status bar or tap *PATIENT DATA* in the quick menu.
- Select the appropriate patient category.
- Follow on-screen instructions.

## 3.6 Select ventilation type

- Select invasive or non invasive ventilation in *STANDBY*.

**Note:** The default values may have been changed by a previous user.

### 3.7 Set ventilation mode

- Tap *MODES* in *STANDBY* to open the *MODES* window.
- Select mode.

**Note:** Tap and hold the tile to access more information about the selected mode.

- When a ventilation mode has been selected, all parameters can be set in the mode settings window.
- Tap a parameter to adjust its value.
- Tap *Accept* to confirm, or *Cancel* to cancel the settings.

#### 3.7.1 Safety scales

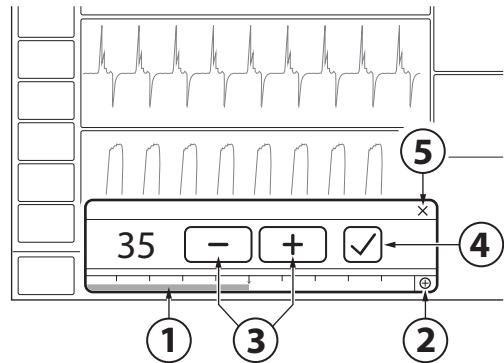

1. Slide the bar to the right or left to increase or decrease the settings. The bar displays the safety scale, that is the range that is safe to use for most patients.
2. The safety scale can be overridden by tapping here. This gives access to the full settings range.
3. Tap to incrementally increase or decrease the setting. Tap and hold to rapidly increase or decrease the setting.
4. Confirm the setting by tapping *Accept*.
5. Exit settings without changing by tapping *cancel*.

### 3.8 Set alarm limits

- Tap *ALARM LIMITS* in the quick menu.
- The limits are set in the alarm limit bars in the *ALARM LIMITS* window.

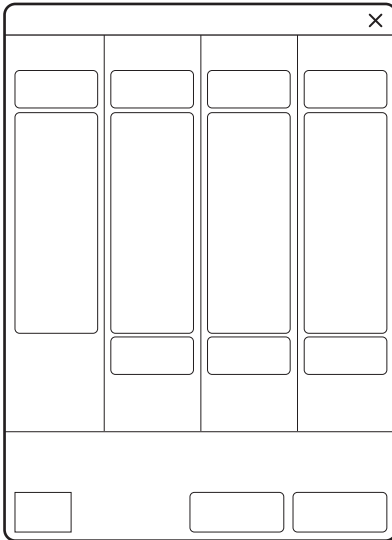

- Tap the upper or lower value in the selected alarm limit bar.
- A scale appears, tap plus or minus or slide the bar to set the value.

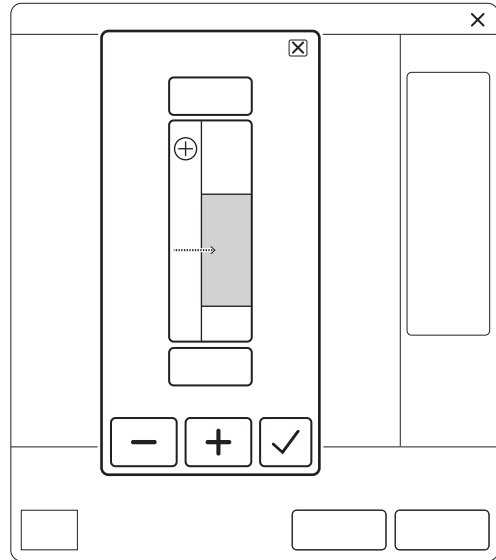

- Confirm each setting by tapping *Accept*.
- Tap *Autoset all alarms*, if desired, to get alarm limit proposals for the following modes:
  - VC
  - PC
  - PRVC

**Important:** Before accepting *Autoset all alarms* values, make sure they are appropriate for the patient. If not, enter settings manually.

- To activate the new alarm limits tap *Accept*.

**Notes:**

- VC is not available in the neonatal patient category.
- *Autoset all alarms* is not available in supported or *NIV* modes or in *STANDBY* because the ventilator system requires patient values in order to propose alarm limits.

A minimum alarm sound level can be set in *SERVICE & SETTINGS/STARTUP CONFIGURATION/ALARMS*. The alarm sound level that is set in the *ALARM LIMITS* window cannot be set at a lower level than set minimum alarm sound level.

### 3.8.1 Set alarm sound level

**WARNING!** The ambient sound needs to be taken into consideration when setting the alarm sound level.

- Tap *ALARM LIMITS* in the quick menu.
- Tap alarm sound level.

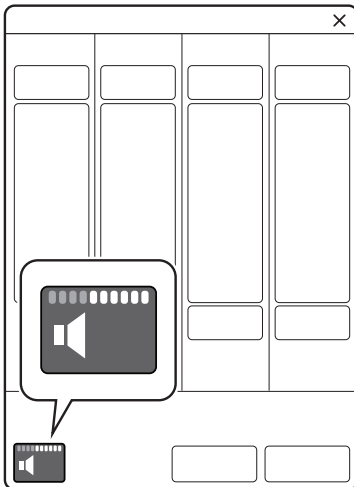

- Tap the sound level bar to set appropriate alarm sound level.
- Tap *Accept*.



### 3.9 Enter patient data

- Tap the patient data shortcut in the status bar or tap *PATIENT DATA* in the quick menu.
- Tap in the selected input field to open a keyboard or keypad.
- Tap Accept to confirm new data.
- Enter/edit the following data:
  - *Patient category*
  - *Name*
  - *Date of birth / ID*
  - *Gender*
  - *Height*
  - *Weight*

**Note:** If gender, height and weight have been entered, predicted body weight will be automatically displayed.

Refer to section Settings-related information on page 116.

**Note:** The gender and height entered will effect the displayed data in SERVO COMPASS.

- Tap *Done* when entry is complete.

### 3.10 Start ventilation

Tap *START VENTILATION* in *STANDBY* or *START* in the quick menu to start ventilation.

**WARNING!** Ventilation must be started manually when a patient is connected to the ventilator system.

### 3.11 Stop ventilation

To disconnect and stop ventilation:

- Physically disconnect the patient from the ventilator system.
- Tap *STANDBY* in the quick menu.
- Tap and hold *STOP VENTILATION* to stop ventilation.



## 4 Displaying and saving data

### Table of contents

|     |                          |  |    |
|-----|--------------------------|--|----|
| 4.1 | Views                    |  | 48 |
| 4.2 | SERVO COMPASS            |  | 54 |
| 4.3 | Trends, Logs & Media     |  | 56 |
| 4.4 | Ventilator configuration |  | 60 |
| 4.5 | System status            |  | 60 |

## 4.1 Views

The ventilator system offers different views to suit different needs. They are accessed via the quick menu during ventilation.

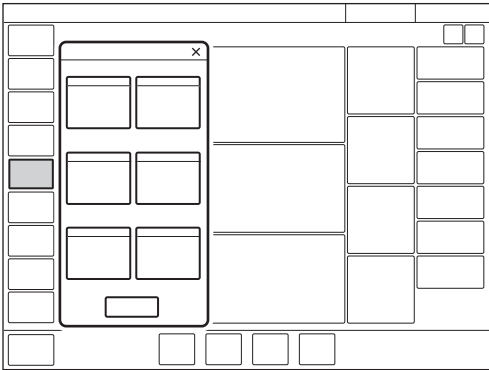

### 4.1.1 Basic view

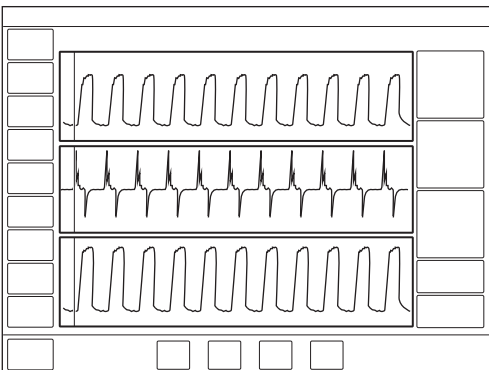

The view consists of:

- two or three waveforms – pressure and flow waveforms are always present, together with the volume waveform, if desired
- a single column of numerical values

#### Notes:

- The *BASIC* view is not available if an Edi or CO<sub>2</sub> module is connected.
- All non invasive ventilation modes except NIV NAVA start in the *BASIC* view.

It is possible to adjust the layout by tapping either *SCREEN LAYOUT* in the extended menu or *VIEWS/Screen layout* in the quick menu.

Refer to section *Adapting the waveform display* on page 52.

This makes it possible to show or hide the volume waveform.

It is also possible to adjust the scaling, sweep speed, appearance of the waveforms and user interface brightness in the *SCREEN LAYOUT* window.

If an Edi module and/or a CO<sub>2</sub> module are connected, the view will automatically switch to *ADVANCED*.

## High Flow therapy

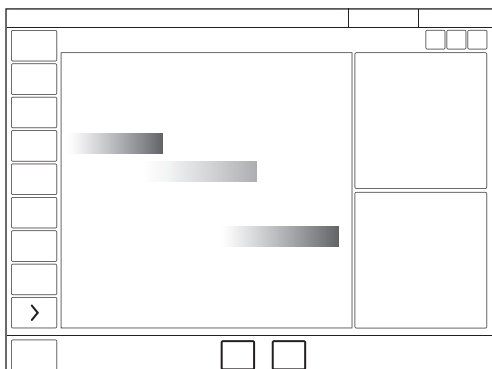

- The High Flow basic view contains two measured values: Inspiratory flow and  $\text{FiO}_2$ .
- To illustrate the flow, a flow animation is shown.
- If an Edi module is connected, the Edi waveform, the  $\text{Edi}_{\text{peak}}$  and  $\text{Edi}_{\text{min}}$  measured values and up to 24 hours trends will be displayed.

### 4.1.2 Advanced view

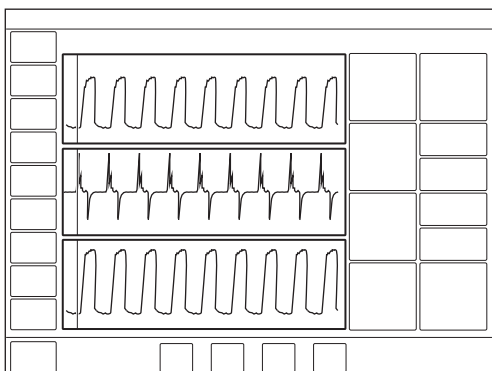

The view consists of:

- two to five waveforms – pressure and flow waveforms are always present, together with the volume waveform, if desired, and the Edi and  $\text{CO}_2$  waveforms, if available
- two columns of numerical values

The SERVO COMPASS can be included in the **ADVANCED** view.

Refer to section SERVO COMPASS on page 54.

#### Notes:

- The **ADVANCED** view is not available in Nasal CPAP.
- All invasive ventilation modes start in the **ADVANCED** view.

It is possible to adjust the layout by tapping either **SCREEN LAYOUT** in the extended menu or **VIEWS/Screen layout** in the quick menu.

Refer to section Adapting the waveform display on page 52.

This makes it possible to show or hide the volume waveform and the Edi or  $\text{CO}_2$  waveforms, if relevant modules or SERVO COMPASS are connected.

Refer to section SERVO COMPASS on page 54

It is also possible to adjust the scaling, sweep speed, appearance of the waveforms and user interface brightness in the **SCREEN LAYOUT** window.

## High Flow therapy

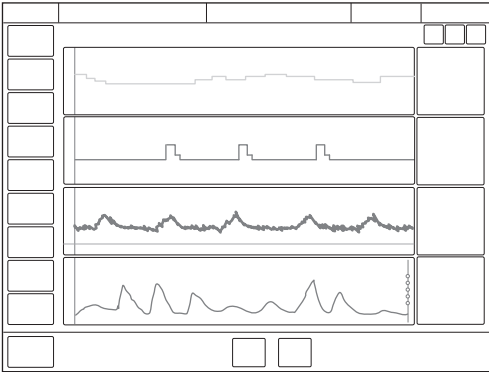

- The advanced view is a combination of currently measured values and trends.
- Advanced view includes up to 24 hours of measured inspiratory flow and FiO<sub>2</sub>.
- If an Edi module is connected, the Edi waveform, the Edi<sub>peak</sub> and Edi<sub>min</sub> measured values and up to 24 hours trends will be displayed.

### 4.1.3 Loops view

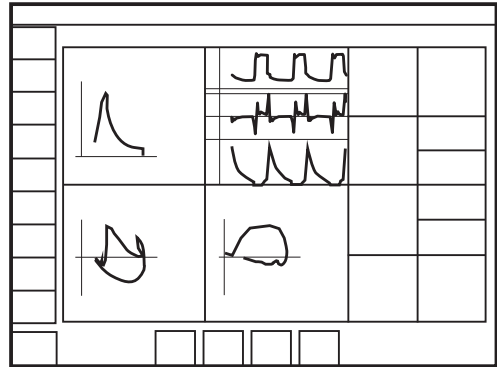

This view provides a graphical representation of the relationship between pressure-flow, pressure-volume and volume-flow.

The view consists of:

- up to three loops – pressure-flow, pressure-volume and volume-flow
- two to five waveforms – pressure and flow waveforms are always present, together with the volume waveform, if desired, and the Edi and CO<sub>2</sub> waveforms, if available
- two columns of numerical values

The SERVO COMPASS can be included in the LOOPS view.

Refer to section SERVO COMPASS on page 54.

**Note:** The *LOOPS* view is not available in non invasive modes.

It is possible to adjust the layout by tapping either *SCREEN LAYOUT* in the extended menu or *VIEWS/Screen layout* in the quick menu.

This makes it possible to show or hide the volume waveform and the Edi or CO<sub>2</sub> waveforms, if relevant modules connected.

It is also possible to adjust the scaling, sweep speed, appearance of the waveforms and user interface brightness in the *SCREEN LAYOUT* window.

Refer to section *Adapting the waveform display* on page 52.

In addition, all loops can be shown or hidden. The maximum number of loops displayed is three, in which case no more than three waveforms may be displayed. When only three waveforms can be displayed the Edi waveform will, if available, automatically replace both volume and CO<sub>2</sub> waveforms. The loops may also be displayed with or without a loop grid by tapping *Loop grid*.

To retain a reference loop (1) or see two overlaid loops simultaneously (2):

1. Tap the reference loop symbol. A reference loop will then be displayed together with a time stamp.
2. Tap the two overlay loops symbol to display the two previous loops.

#### 4.1.4 Distance view

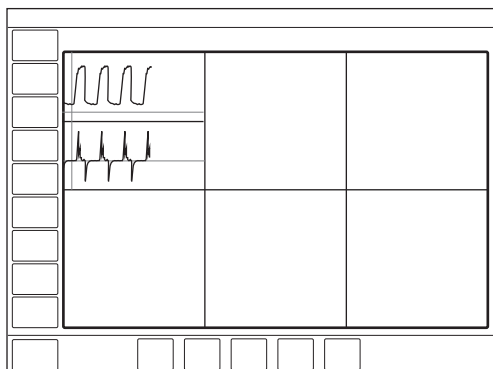

The view is designed for optimal readability from a distance. Information displayed includes numerical values and waveforms.

There are six large tiles displaying:

- five enlarged numerical values
- the pressure and flow waveforms, as well as the Edi waveform, if available

The *SERVO COMPASS* can be included in the *DISTANCE* view.

Refer to section *SERVO COMPASS* on page 54.

The screen layout cannot be adjusted.

#### 4.1.5 Family view

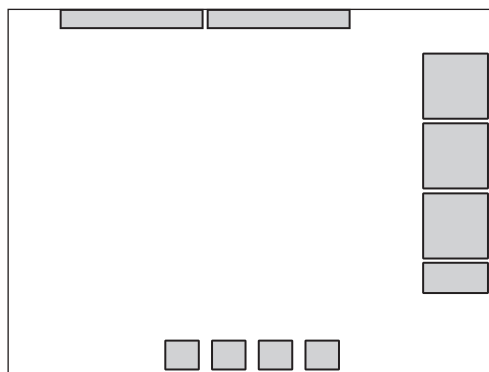

The view has a neutral background image and may be used during family visits to hide the standard user interface.

Displayed information is minimized to:

- one column of numerical values
- the direct access bar
- alarms and messages in the status bar
- a dynamic representation (moving bubbles) showing that ventilation is in progress.

The screen layout cannot be adjusted.

Tap anywhere on the screen for rapid access to the most recently used view.

### 4.1.6 Displaying waveforms

The ventilator system can display up to five waveforms depending on the view selected.

The waveforms displayed on the user interface are:

- pressure – (yellow)
- flow – (green)
- volume – depending on view selected and layout adjustments (blue)
- CO<sub>2</sub> concentration – available when a module is connected (light yellow)
- Edi – available when a module is connected (pink)

### Adapting the waveform display

It is possible to adapt the waveform display via the scaling function.

- Tap and hold a displayed waveform.
- In the window that opens, adjust the scaling function manually or use *Auto* to scale automatically.
- To close the window, tap anywhere on the screen other than the opened window.

Alternatively:

- Adjust the layout by tapping either *SCREEN LAYOUT* in the extended menu or *IEWS/Screen layout* in the quick menu.
- Tap the tile shown in the figure directly to the left of each waveform name.

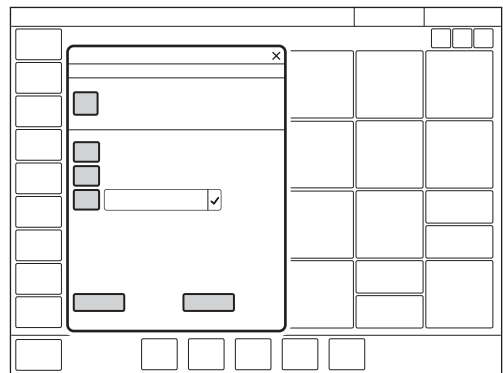

It is also possible to show or hide non-mandatory waveforms in the *SCREEN LAYOUT* window.

The sweep speed can also be adjusted by tapping *Sweep speed* and selecting 5, 10 or 20 mm/s.

In addition, there is a choice under *Appearance* between filled and unfilled waveforms.



## Estimated pressure ( $P_{est}$ ) waveform

When an Edi module and an Edi catheter are connected, the pressure waveform will by default be adapted so that the  $P_{est}$  waveform (gray) is displayed simultaneously with the standard pressure waveform. The waveform heading will change to Pressure/ $P_{est}$ .

Refer to section Position Edi catheter and set NAVA level on page 85 and section Edi monitoring on page 121.

To make changes:

- Tap and hold either the pressure waveform or the Edi waveform, if available.
- Tap the  $P_{est}$  tile that is present in the window if the Edi signal is being monitored.
- If the  $P_{est}$  waveform is already present, tapping the tile will hide it.
- Tapping it again will restore the  $P_{est}$  waveform if it was removed.

## 4.1.7 Displaying numerical values

During ventilation, numerical values (measured or calculated) are displayed on the right side of the screen.

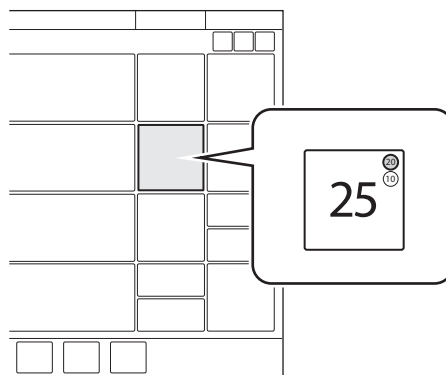

- Alarm limits (if applicable) are displayed in small digits for each numerical value.
- Values that are off the scale are replaced by three asterisks.
- Values that are uncertain are indicated by a single asterisk.

Depending on the view selected, one or three columns of numerical values are displayed, including ADVANCED view and SERVO COMPASS.

To access additional values, tap the arrow at the right edge of the screen to display all numerical values.

## 4.2 SERVO COMPASS

### 4.2.1 Displaying SERVO COMPASS

SERVO COMPASS visualizes volume and pressure in relation to set targets in invasive modes.

To set and monitor the volume target, PBW must first be calculated.

Refer to section Predicted body weight (PBW) on page 116.

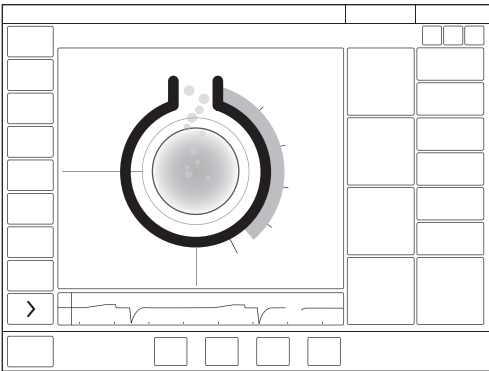

The SERVO COMPASS consists of:

- two columns of numerical values
- one or two waveforms - flow together with the Edi, if available
- the SERVO COMPASS - a graphical representation of actual numerical values for volume and pressure

#### Notes:

- The SERVO COMPASS can be included in *ADVANCED*, *LOOPS* and *DISTANCE* views.
- It is possible to adjust the layout by tapping either *SCREEN LAYOUT* in the extended menu or *VIEWS/Screen layout* in the quick menu.
- SERVO COMPASS is not available in non invasive modes.

### 4.2.2 Ventilation targets

#### Volume (VT/PBW):

The set volume target is compared with the actual value. If there is a deviation of 20% or more, the volume animation changes color from blue to orange to indicate that ventilation is suboptimal and adjustments should be considered.

#### Pressure (cmH<sub>2</sub>O)

The set target is to remain below the set pressure limit. The limit may be set on:

- total pressure i.e. end-inspiratory pressure
- driving pressure i.e. end-inspiratory pressure minus positive end-expiratory pressure

If the actual driving or total pressure exceeds the pressure limit, the pressure animation will change color to indicate that ventilation is suboptimal and adjustments should be considered.

$P_{drive}$  is displayed in following ventilation modes:

- VC
- PC
- PRVC

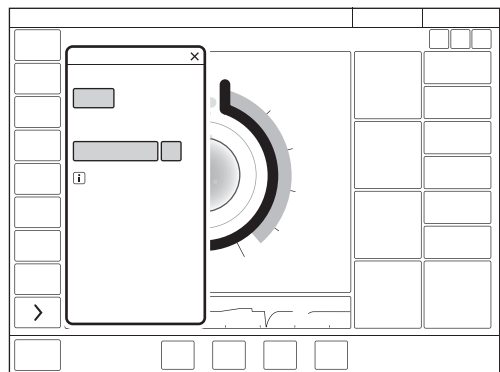

Tap in the SERVO COMPASS view near the set targets to open the *VENTILATION TARGETS* window.

To store a reference measurement:  
Tap the SERVO COMPASS reference measurement symbol. The reference measurements will be indicated by blue lines in SERVO COMPASS together with a time stamp under the symbol.

### 4.2.3 Advanced view

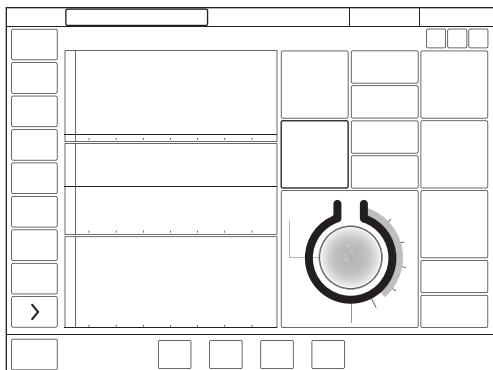

The view consists of:

- two to five waveforms – pressure and flow waveforms are always present, together with the volume waveform, if desired, and the Edi and CO<sub>2</sub> waveforms, if available
- three columns of numerical values

When SERVO COMPASS is activated in the *ADVANCED* view, the graphical representation is illustrated in the numerical values.

### 4.2.4 Loops view

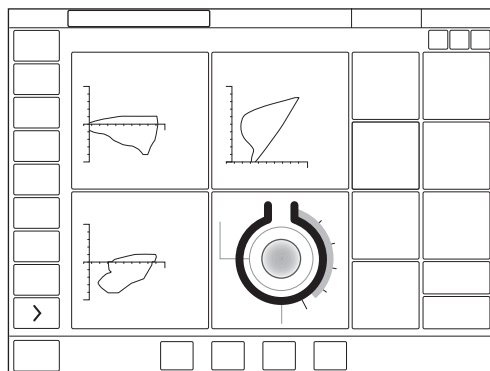

The view consists of:

- up to three loops – pressure-flow, pressure-volume and volume-flow
  - SERVO COMPASS
  - up to five waveforms – pressure and flow waveforms are always present, together with the volume waveform, if desired, and the Edi and CO<sub>2</sub> waveforms, if available
- The waveforms cannot be shown if three loops and SERVO COMPASS are displayed.
- two columns of numerical values

### 4.2.5 Distance view

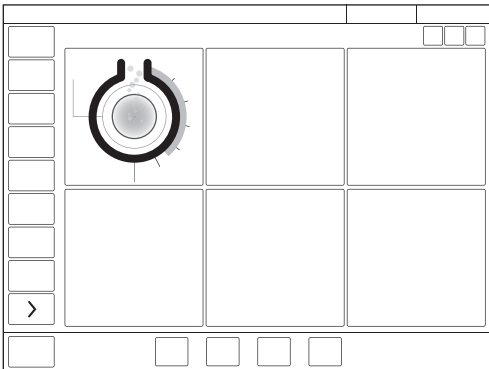

There are six large tiles displaying:

- five enlarged numerical values
- SERVO COMPASS

## 4.3 Trends, Logs & Media

*TRENDS&LOGS* in the extended menu includes *TRENDS*, *LOGS*, *MEDIA* and *EXPORT FILES*.

### 4.3.1 Trends

Trend values are stored every 60 seconds and retained for a maximum of 72 hours. Stored events and system changes are also displayed here.

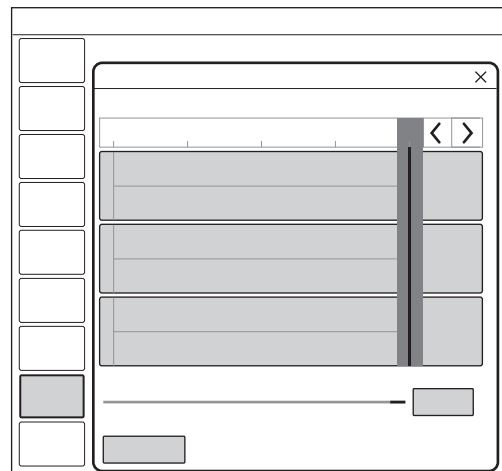

To view trends:

- In the extended menu, tap *TRENDS & LOGS /TRENDS*.
- Scroll between the different trended values.
- To adjust the time resolution, tap the number of hours displayed at bottom right.
- To scroll along the time axis, activate the cursor and move it back and forth or use the arrows in the upper right part of the window.
- The time valid for the cursor position is displayed. If events have been stored, their number is displayed in the circle shown in the figure and an explanation appears to the left of this circle.

- If a recording is saved at a time corresponding to the cursor position, a recorder is displayed. To view the recording, tap this recorder.
- Tap *Organize* in the *TRENDS* window to place the trends in the desired order by dragging and dropping the different trended values presented.

Refer to section Trends on page 195.

### 4.3.2 Logs

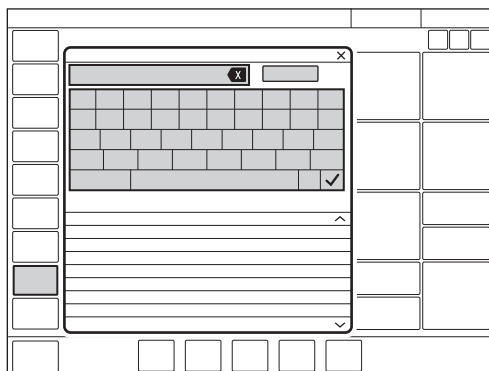

To view the event log:

- In the extended menu, tap *TRENDS & LOGS /LOGS*.
- Scroll among all the events listed.
- The *LOGS* window offers a search function. Tap the text field to open the keyboard and enter a search word. To display only log items that contain the search word entered, tap *Filter*. Tap again to deactivate the filter.
- Use the backspace arrow to delete the search word.

Each event includes the event time and date. The event log is cleared when a new patient is admitted.

Refer to section Event log on page 196.

### 4.3.3 Media

The screenshots and recordings are stored under *TRENDS & LOGS/MEDIA*, which is accessed via the extended menu.

Data can be saved in a number of ways:

- as screenshots
- as recordings
- as files for export including event log, trends and both the above.

Data can later be exported to a USB memory stick.

#### Saving screenshots

To save a screenshot, tap the camera in the status bar.

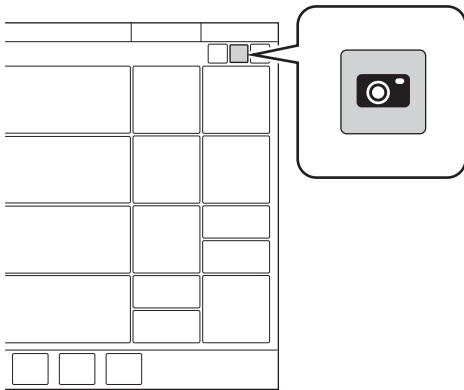

The screenshot will be stamped with the date and time it was taken and saved under the *Saved screens* tab in the *MEDIA* window.

There is space for 40 screenshots under this tab. When the memory is full, it can be erased or oldest screenshot can be erased.

#### Viewing saved screens

To view screenshots, tap *TRENDS & LOGS/MEDIA /Saved screens* in the extended menu. Choose the relevant screenshot displayed at the bottom of the window. If there are more than ten screens saved, scroll to the right to find more.

#### Recording waveforms

To make a recording, tap the recorder (not available in Standby) in the status bar.

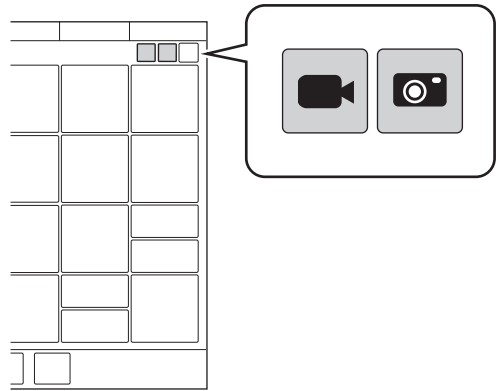

A 30 second long recording will be made starting 15 seconds before, and lasting until 15 seconds after the time the recording was initiated. A blue progress bar will be displayed under the recorder while the recording is being made.

The recording will be stamped with the date and time that it was initiated and will be saved under the *Recordings* tab in the *MEDIA* window. All settings applying at the time the recording is initiated will also be saved.

There is space for 40 recordings under this tab. When the space is full, the next recording made will erase the oldest one.

## Viewing recordings

To view recordings, tap *TRENDS & LOGS/MEDIA /Recordings* in the extended menu. Choose the relevant recording displayed at the bottom of the window. If more than ten recordings have been saved, scroll to the right to find more.

The cursor (pale green) is positioned on the dotted line indicating the middle point of the recording. It is activated by moving it or by pressing the arrows to the right of the recorder seen above the dotted line. The values at the cursor position are displayed in digits to the right of the waveform name in the recording window.

When viewing a recording, it is also possible to view the settings by tapping *Settings* at the bottom left of the window. This will open a list of the actual parameter settings in use at the time the recording was initiated.

## Exporting and deleting data

To export or delete screenshots or recordings, tap *TRENDS & LOGS/MEDIA /Export & Delete* in the extended menu.

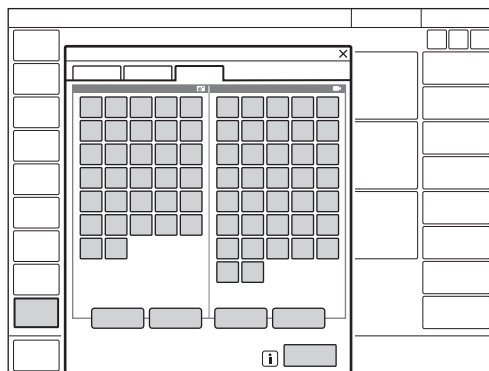

Both screenshots and recordings can be selected for export or deletion.

The following data will be exported to a USB memory stick:

- Event log
- Trends
- Saved screens & recordings

**Important:** Only a USB memory stick may be connected to the USB port.

### 4.3.4 Export files

To export all files to a USB memory stick, tap *TRENDS & LOGS/EXPORT FILES*, in the extended menu.

## 4.4 Ventilator configuration

The ventilator system will always start up with the stored configuration settings.

To view the stored configuration settings, tap *CONFIGURATION* in the extended menu:

The following configurations can be viewed:

- *Alarms*
- *General*
- *Units*
- *Startup configuration*

The alarms configuration can be viewed for each of the patient categories. The other configurations do not vary with patient category.

**Note:** No editing can be done under *CONFIGURATION*.

Refer to chapter *Service & Settings* on page 163.

## 4.5 System status

To view the current status of the ventilator system:

- Tap *SYSTEM STATUS* in the quick menu in Standby.
- Tap *SYSTEM STATUS* in the extended menu during ventilation.

The *SYSTEM STATUS* window that opens contains:

1. *Installed options*
2. *General*
3. *Batteries*
4. *Expiratory cassette*
5. *Modules* – (if connected) *CO<sub>2</sub> module*, *Y sensor module*, *Edi module*
6. *Pre-use check*
7. *O<sub>2</sub> cell/O<sub>2</sub> sensor*
8. *Patient circuit*



### 4.5.1 Battery status

Detailed information about batteries is accessed via *SYSTEM STATUS/Batteries*. There is also an indication in the status bar showing the power supply currently being used by the ventilator system.

If the ventilator system is running on battery power, the battery symbol turns yellow and the mains power symbol disappears. The estimated remaining battery time in minutes is always displayed, regardless of the power supply in use.

This also functions as a shortcut to the window otherwise accessed via *SYSTEM STATUS/Batteries*.

The following information is displayed under *Batteries* in *SYSTEM STATUS* for each connected battery module:

- *BATTERY CAPACITY* – usable backup time in minutes

**Note:** The total usable backup time is the sum of the estimated operation time displayed for each battery module minus 10 minutes.

- Slot number
- Serial number
- Remaining operation time in minutes
- Notification – may be displayed close to the remaining operation time in minutes:

| Notification           | Response   |
|------------------------|--|
| <i>Expires soon</i>    | Order a new battery module.                                |
| <i>Replace battery</i> | The battery is no longer reliable; replace it immediately. |

- Charge indicator, where
  - 0 boxes filled = < 10 % relative charge
  - 1 box filled = 10-25 % relative charge
  - 2 boxes filled = 26-50 % relative charge
  - 3 boxes filled = 51-75 % relative charge
  - 4 boxes filled = 76-100 % relative charge

#### **Important:**

- If *Replace battery* is displayed, the battery is unreliable, regardless of the operating time displayed under *Batteries*. In this situation, replace the battery even when the *STATUS* window indicates that significant operating time remains.
- When using an external 12V DC supply, two battery modules must be installed to ensure proper operation.



## 5 Ventilation modes and therapies

### Table of contents

|      |  |  |     |
|------|--|--|-----|
| 5.1  | Introduction                             |  | 64  |
| 5.2  | Pressure Control (PC)                    |  | 65  |
| 5.3  | Pressure Regulated Volume Control (PRVC) |  | 67  |
| 5.4  | Volume Control (VC)                      |  | 69  |
| 5.5  | Bi-Vent/APRV                             |  | 73  |
| 5.6  | Pressure Support (PS)/CPAP               |  | 75  |
| 5.7  | Volume Support (VS)                      |  | 78  |
| 5.8  | NAVA                                     |  | 81  |
| 5.9  | Automode                                 |  | 90  |
| 5.10 | SIMV                                     |  | 93  |
| 5.11 | Non Invasive Ventilation (NIV)           |  | 96  |
| 5.12 | NIV Pressure Control (NIV PC)            |  | 99  |
| 5.13 | NIV Pressure Support (NIV PS)            |  | 100 |
| 5.14 | NIV NAVA                                 |  | 101 |
| 5.15 | Nasal CPAP                               |  | 102 |
| 5.16 | High Flow therapy                        |  | 104 |

## 5.1 Introduction

### 5.1.1 Safety guidelines

Not all safety guidelines apply to all modes and therapies.

#### **WARNINGS!**

- Self-triggering should be avoided. Do not set the trigger level too low.
- The following warnings apply to non invasive ventilation (NIV) modes only:
  - Avoid high inspiratory pressure as it may lead to gastric overdistension and risk of aspiration. It may also cause excessive leakage.
  - Ensure adequate external monitoring for Nasal CPAP and High Flow therapy.

#### **Important:**

- Be sure to set alarm limits as appropriate for each mode, especially those for:
  - expired minute volume
  - apnea time
  - airway pressure
- To protect the patient's lungs from excessive pressure it is important to set the upper pressure limit to a suitable value.
- It is important to avoid leakage so as to ensure the proper functioning of modes such as:
  - PRVC
  - VS
  - Automode PRVC ⇔ VS
  - SIMV (PRVC) + PS

- In the neonatal patient category, there is a leakage compensation function available in all invasive modes except Bi-Vent/APRV. Refer to section Leakage compensation on page 119.
- The circuit compensation function should be used – it is important to make sure that the compressible volume of the patient circuit is **not** changed after the pre-use check/patient circuit test has been performed (e.g. filling an active humidifier with water or connecting a filter after the test has been performed).
- For the neonatal patient category, the ventilator system has a volume restriction. This means that the alarm limit set for VT<sub>i</sub> restricts volume delivery, so that a higher volume than set by this limit will not be delivered. This applies in:
  - PC
  - PS
  - Automode PC ⇔ PS
  - all SIMV modes

#### **Note:**

The ventilator system is delivered preset with the following configuration options:

- Ventilatory settings are based on either minute volume or tidal volume.
- Ventilatory settings are based on either I:E ratio or inspiration time.

## 5.2 Pressure Control (PC)

PC:

- delivers a constant pressure over a preset inspiratory time and at a preset respiratory rate;
- delivers the inspiration with a decelerating flow;
- changes in lung or thorax resistance or compliance will affect the volume delivered.

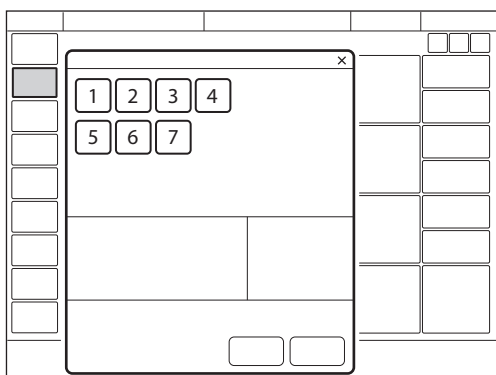

The following parameters are set:

1. Oxygen concentration (%)
2. PEEP (cmH<sub>2</sub>O)
3. Respiratory rate (b/min)
4. PC above PEEP (cmH<sub>2</sub>O)
5. I:E ratio or Inspiration time (s)
6. Inspiratory rise time (% or s)
7. Trigger

Refer to section Important settings on page 108.

The delivered volume is dependent on the pressure above PEEP, lung compliance and resistance in the patient circuit and airways. This means that the tidal volume can vary.

The flow during inspiration is decelerating. The patient can trigger extra breaths. As the delivered tidal volume can vary, it is very important to set alarm limits for the minute volume to adequate levels.

PC ventilation is often preferred when there is leakage in the patient circuit, e.g. due to an uncuffed endotracheal tube, or in situations where the maximum airway pressure must be controlled.

If a patient tries to exhale during inspiration, pressure increases. When it increases 3 cmH<sub>2</sub>O above the set inspiratory pressure level, the active expiratory valve opens and regulates the pressure down to the set inspiratory pressure level. If the pressure increases to the set upper pressure limit, e.g. if the patient is coughing, the expiratory valve opens and the ventilator system switches to expiration.

### 5.2.1 Pressure Control in detail

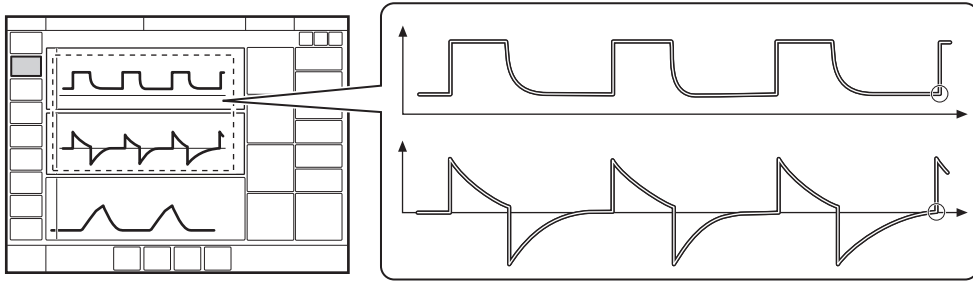

The circles in the figure indicate patient triggering.

- PC ensures that the preset inspiratory pressure level is constant throughout inspiration. Breaths are delivered in accordance with the preset respiratory rate, inspiration time and inspiratory pressure level, resulting in a decelerating flow.
- The preset pressure level is controlled by the ventilator system. The resulting volume depends on the set pressure level, the inspiration time and the mechanical properties of the patient's lungs during each breath.
- Inspiration starts in accordance with the preset respiratory rate or when the patient triggers.

#### Expiration starts:

- After the termination of the preset inspiration time.
- If the upper pressure limit is exceeded.

### 5.3 Pressure Regulated Volume Control (PRVC)

PRVC:

- combines the advantages of Volume Control and Pressure Control by delivering a preset tidal volume with a decelerating inspiratory flow at a preset respiratory rate;
- maintains the lowest possible constant pressure throughout inspiration;
- the inspiratory pressure of a breath will not exceed 5 cmH<sub>2</sub>O below the upper pressure limit.

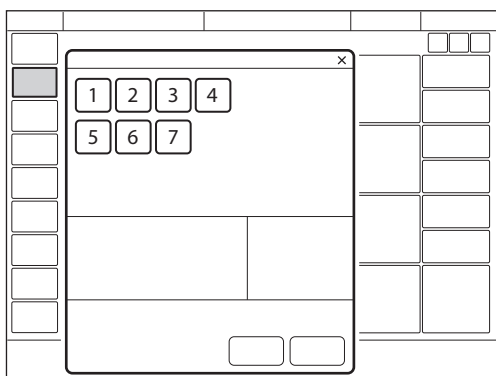

The ventilator system can be configured so that either tidal volume or minute volume is set.

The following parameters are set:

1. Oxygen concentration (%)
2. PEEP (cmH<sub>2</sub>O)
3. Respiratory rate (b/min)
4. Tidal volume (ml) or minute volume (l/min)
5. I:E ratio or Inspiration time (s)
6. Inspiratory rise time (% or s)
7. Trigger

Refer to section Important settings on page 108.

The ventilator system delivers a preset tidal volume. The pressure is automatically regulated to deliver this volume but limited to 5 cmH<sub>2</sub>O below the set upper pressure limit.

The flow during inspiration is decelerating. The patient can trigger extra breaths.

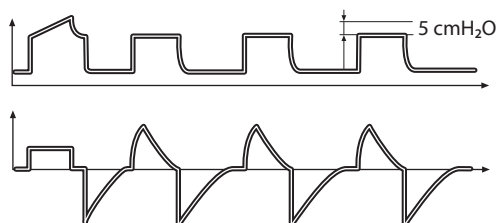

The first breath is a volume controlled test breath with the pause time set to 10 %. The measured pause pressure of this breath is then used as the pressure level for the following breath.

For the neonatal patient category when leakage compensation is activated in PRVC, the first breath is a pressure controlled breath given with 5 cmH<sub>2</sub>O above PEEP.

Following the initial breath, the ventilator system calculates and continuously regulates the pressure needed to deliver the preset tidal volume.

An alarm is activated if the set target volume cannot be delivered due to the fact that the pressure required to deliver it is higher than 5 cmH<sub>2</sub>O below the set upper pressure limit.

**Note:** For the neonatal patient category, activated leakage compensation ensures volume delivery at the level set.

Refer to section Leakage compensation on page 119.

### 5.3.1 PRVC in detail

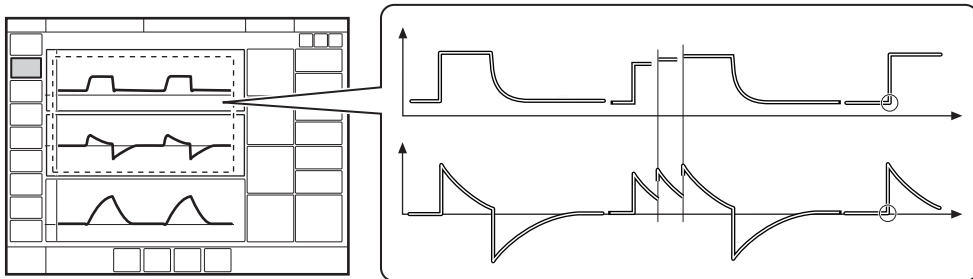

The circles in the figure indicate patient triggering.

- PRVC ensures a set target minute ventilation to the patient. The target volume is based on settings for tidal volume, respiratory rate and inspiration time.
- The inspiratory pressure level is constant during each breath, but automatically adapts in small increments on a breath-by-breath basis to match the mechanical properties of the patient's lungs, thus ensuring delivery of the target volume.
- Inspiration starts in accordance with the preset respiratory rate or when the patient triggers.

#### Expiration starts:

- After the termination of the preset inspiration time.
- If the upper pressure limit is exceeded.



## 5.4 Volume Control (VC)

**Note:** VC is not available in the neonatal patient category.

VC:

- delivers a preset tidal or minute volume over a preset inspiratory time and at a preset respiratory rate, regardless of changes in lung or thorax resistance or compliance;
- maintains a set flow with varying peak pressure.

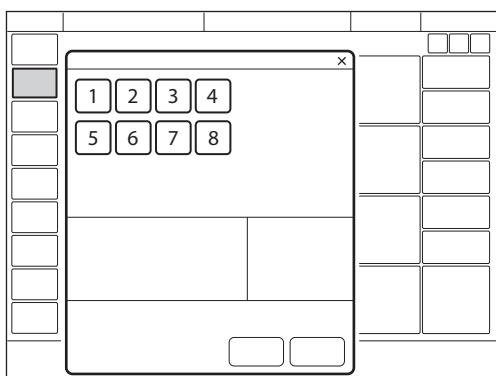

The ventilator system can be configured so that either tidal volume or minute volume is set.

The following parameters are set:

1. Oxygen concentration (%)
2. PEEP (cmH<sub>2</sub>O)
3. Respiratory rate (b/min)
4. Tidal volume (ml) or minute volume (l/min)
5. I:E ratio or Inspiration time (s)
6. Pause time (% or s)
7. Inspiratory rise time (% or s)
8. Trigger

Refer to section Important settings on page 108.

The airway pressure is dependent on the tidal volume, the inspiration time and the resistance and compliance of the respiratory system. The set tidal volume will always be delivered. An increase in resistance and decrease in compliance will lead to an increased airway pressure. The delivered pressure can vary, so in order to protect the patient's lungs from excessive pressure, it is very important to set the upper pressure limit to a suitable value.

Patients may trigger extra breaths if they can overcome the set trigger level.

### 5.4.1 Flow adaptation

Patient inspiratory efforts can also result in a higher inspiratory flow and tidal volume than were preset.

Thus, if the patient demands a higher flow than the calculated constant flow, the system will sense any sudden pressure drop of  $> 3$  cmH<sub>2</sub>O and temporarily enables PS to deliver a higher flow adapted to patient demand.

#### Flow adaptation setting

The flow adaptation can be set to:

- Volume Control with flow adaptation  
The function is described in section Flow adaptation.
- Volume Control without flow adaptation  
Breathing frequency instead of flow may increase during inspiration for a patient who needs more ventilation.

**Note:** Set trigger sensitivity at an adequate level. A patient who needs more ventilation may increase the breathing frequency instead of increasing the flow during inspiration.

The flow adaptation setting may be enabled or disabled in *SERVICE & SETTINGS/BIOMED/CONFIGURATION/STARTUP CONFIGURATION*.

Refer to section Startup Configuration on page 166.

When enabled, the flow adaptation can be activated/deactivated in the *VOLUME CONTROL* window.

### 5.4.2 Decelerating flow

VC delivers a constant flow or a decelerating flow with a set flow pattern.

The flow pattern describes the end inspiratory flow in relation to the peak inspiratory flow.

#### Flow pattern setting

The flow pattern can be set between 0-100 %.

- A flow pattern setting of 100% equals constant flow.
- A flow pattern setting below 100% delivers a decelerating flow with greater deceleration the lower the setting.

Flow adaptation is not available if the flow pattern is set to a decelerating flow.

The flow pattern setting may be enabled or disabled in *SERVICE & SETTINGS/BIOMED/CONFIGURATION/STARTUP CONFIGURATION*.

Refer to section Startup Configuration on page 166.

When enabled, the flow pattern can be set in the *VOLUME CONTROL* window.

## Flow-time waveform

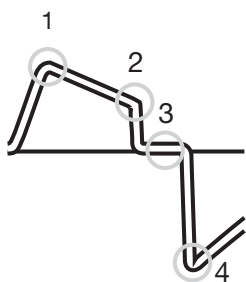

1. Peak inspiratory flow
2. End inspiratory flow
3. Zero flow phase
4. Peak expiratory flow

### 5.4.3 Volume Control in detail

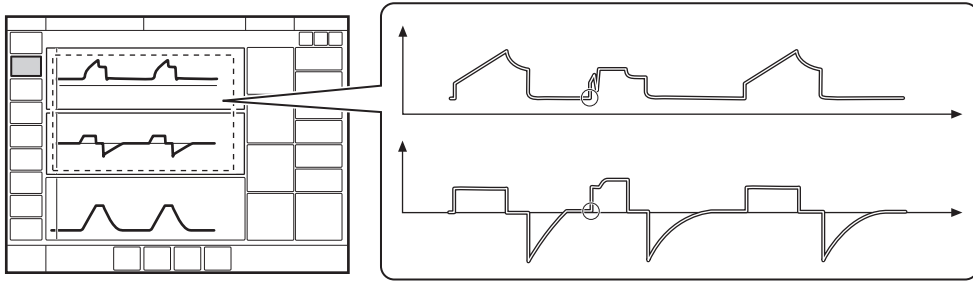

The circles in the figure indicate patient triggering.

- VC ensures a preset tidal volume during a preset inspiratory time at a preset respiratory rate.
  - The inspiratory flow is constant or linearly decelerating and depends on the ventilatory settings.
  - Inspiration starts in accordance with the preset respiratory rate or when the patient triggers.
  - If the patient makes an inspiratory effort during the inspiratory period, when flow adaptation is enabled and flow pattern is 100%, the ventilator system will switch to PS to satisfy the patient's flow demand, as shown in the second breath in the figure.
- Expiration starts:**
- When the preset tidal volume is delivered and after the preset pause time.
  - When the flow returns to the set value after the preset tidal volume is delivered and after the preset pause time (flow adaptation). The patient is however always guaranteed an expiration time corresponding to at least 20 % of the total breath.
  - If the upper pressure limit is exceeded.

## 5.5 Bi-Vent/APRV

### Bi-Vent:

- is a time-cycled, pressure-limited mode that allows spontaneous breathing throughout the entire ventilatory cycle;
- has two time-cycled pressure levels and switches between these two levels. The patient can breathe spontaneously at both these levels and it is possible to give Pressure Support at both levels.

### APRV:

- stands for Airway Pressure Release Ventilation;
- is a time-cycled, pressure-limited mode that allows spontaneous breathing throughout the entire ventilatory cycle;
- alternates between two levels of positive airway pressure, with the main time on the high level and a brief expiratory release to facilitate ventilation;
- differs from Bi-Vent in that it uses an inverse I:E ratio.

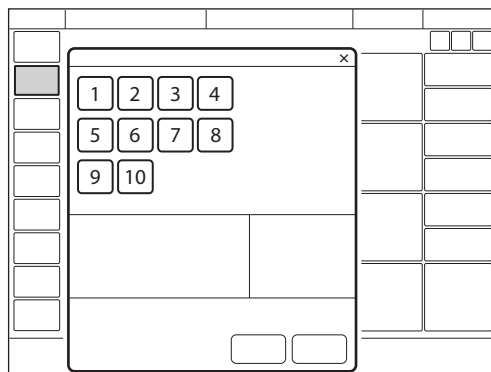

The following parameters are set:

1. Oxygen concentration (%)
2. Pressure at the lower pressure level (PEEP)
3. Pressure at the higher pressure level ( $P_{high}$ ) ( $cmH_2O$ )
4. Time at the higher pressure level ( $T_{high}$ ) (s)
5. Time at the lower pressure level ( $T_{PEEP}$ ) (s)
6. PS above  $P_{high}$  ( $cmH_2O$ )
7. PS above PEEP ( $cmH_2O$ )
8. End inspiration (%)
9. Inspiratory rise time (s)
10. Trigger

Refer to section Important settings on page 108.

### 5.5.1 Bi-Vent/APRV in detail

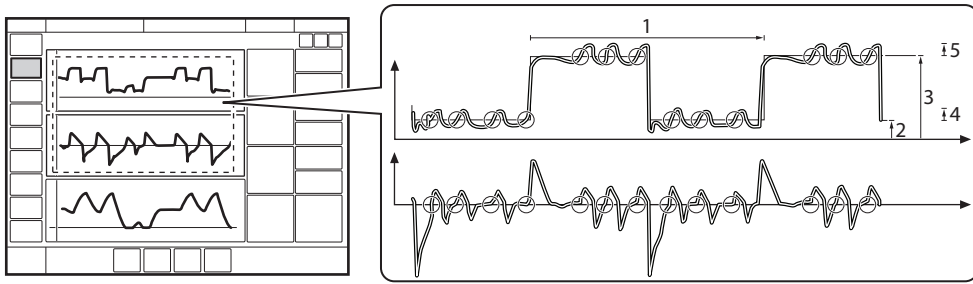

The circles in the figure indicate patient triggering.

1. Bi-Vent/APRV cycle =  $T_{high} + T_{PEEP}$
2. PEEP
3.  $P_{high}$
4. PS above PEEP
5. PS above  $P_{high}$

Each Bi-Vent/APRV cycle is regarded as autonomous and therefore most of the measured values are updated every cycle, i.e. minute volume, respiratory rate, mean pressure and end expiratory pressure. Associated alarms are also handled for every cycle.

Bi-Vent/APRV allows for spontaneous breathing/PS ventilation at two different pressure levels. These basic levels are individually set, as well as the time in seconds at each level. The ventilator system always tries to synchronize with the patient's breathing. The main difference between Bi-Vent and APRV is the inverse I:E ratio in APRV.

At extreme settings, the update of measured values and alarms will show a mandatory frequency dependence even in the face of preserved spontaneous breathing.

Since Bi-Vent/APRV is basically a controlled mode of ventilation, apnea alarm and backup ventilation are not available. It is also very important to set the lower and upper alarm limit for expired minute volume.

As a result of switching between two different pressure levels, the tidal volumes may vary significantly between different breaths. This may also be the case for  $etCO_2$  (end tidal  $CO_2$ ) concentration.

## 5.6 Pressure Support (PS)/CPAP

PS:

- is initiated by the patient, who controls the respiratory rate and tidal volume;
- delivers ventilator support using the preset pressure level and with a decelerating flow;
- provides backup (PC) ventilation in case of apnea.

Continuous Positive Airway Pressure (CPAP):

- is initiated by the patient and works exactly like PS except that the Pressure Support level is set to zero;
- maintains positive pressure in the airways at all times;
- is effectively a spontaneous breathing mode with continuous positive pressure to keep the airways open.

PS is thus a patient-initiated breathing mode in which the ventilator system supports the patient with a set constant pressure.

The ventilator system provides this constant preset pressure when activated by patient effort. The patient determines the frequency and duration of the breaths, which have a decelerating flow pattern. Duration of inspiration can be adjusted with the help of the *End inspiration* setting.

CPAP may be seen as a special case of PS in which the inspiratory pressure level is set to zero and is used when the patient is breathing spontaneously.

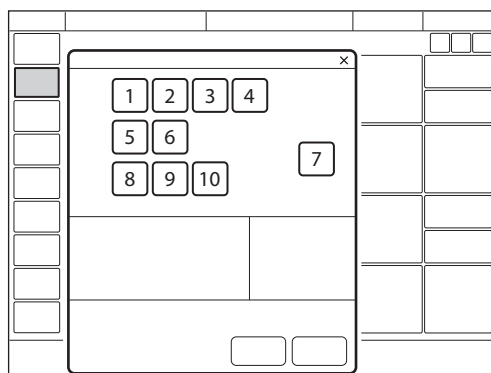

The following parameters are set:

1. Oxygen concentration (%)
2. PEEP (cmH<sub>2</sub>O)
3. PS above PEEP (cmH<sub>2</sub>O) (PS level)
4. End inspiration (%)
5. Inspiratory rise time (s)
6. Trigger
7. Apnea time (s)
8. Backup respiratory rate (b/min)
9. Backup PC above PEEP (cmH<sub>2</sub>O)
10. Backup I:E or Ti (s)

Refer to section Important settings on page 108.

The higher the preset inspiratory pressure level from the ventilator system, the more gas flows into the patient. As the patient becomes more active, the PS level may be gradually reduced.

Always set the apnea time that is appropriate to the individual patient situation. If the apnea alarm limit is reached, the ventilator system will automatically switch to backup ventilation (PC).

The alarm should alert staff to take action by either returning to a supported mode or changing to a controlled mode of ventilation.

It is also very important to set the lower and upper alarm limits for expired minute volume.

The inspiratory rise time should be set to a comfortable value for the patient. In PS, the inspiratory rise time should normally be increased.

The *End inspiration* setting is important to patient comfort and ventilator synchronization with the patient. If the patient's expiratory resistance is high, the *End inspiration* setting should be raised to guarantee enough time for expiration.

It is important to monitor how this affects the tidal volume.



### 5.6.1 PS/CPAP in detail

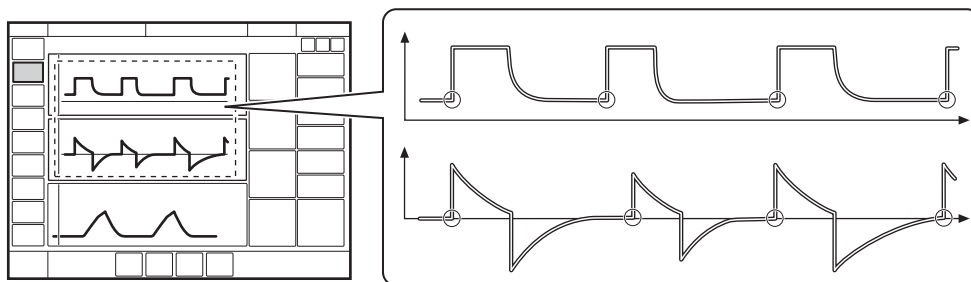

The circles in the figure indicate patient triggering.

- PS ensures that a preset inspiratory pressure level is constantly maintained in response to patient effort.
  - The preset pressure level is controlled by the ventilator system, while the patient determines the respiratory rate and inspiration time.
  - Inspiration starts when the patient triggers a breath and gas flows into the lungs at a constant pressure. Since the pressure provided by the ventilator system is constant, the flow will decrease until the level set for *End inspiration* is reached.
  - For CPAP, inspiration starts upon patient effort.
- Expiration starts:**
- When the inspiratory flow decreases below a preset fraction of the peak inspiratory flow (*End inspiration*)
  - If the upper pressure limit is exceeded
  - If the maximum time for inspiration is exceeded
- Refer to section Functions in ventilation modes on page 193.
- If the flow drops to a range between 25 % of peak flow and the lower limit for *End inspiration*, and remains within the range for a period longer than 50% of the time elapsing between inspiration start and the point when the range was entered.

## 5.7 Volume Support (VS)

VS:

- is initiated by the patient, who controls the respiratory rate;
- delivers ventilator support with a variable peak pressure and decelerating flow to guarantee the preset tidal volume;
- the inspiratory pressure of a breath will not exceed 5 cmH<sub>2</sub>O below the upper pressure limit;
- provides backup (PRVC) ventilation in case of apnea.

A patient-adapted constant inspiratory support is supplied when activated by patient effort. The resulting volume is continuously monitored and the constant inspiratory pressure automatically adjusts to the required level. The patient determines the frequency and duration of the breaths which have a decelerating flow pattern.

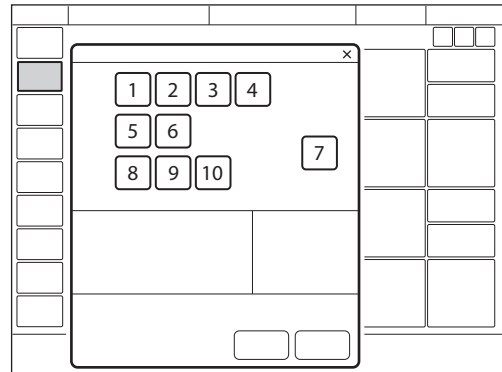

The following parameters are set:

1. Oxygen concentration (%)
2. PEEP (cmH<sub>2</sub>O)
3. Tidal volume (ml)
4. End inspiration (%)
5. Inspiratory rise time (s)
6. Trigger
7. Apnea time (s)
8. Backup respiratory rate (b/min)
9. Backup tidal volume (ml)
10. Backup I:E or Ti (s)

Refer to section Important settings on page 108.

If patient activity increases, the inspiratory support will decrease provided that the set tidal volume is maintained. If the patient breathes below the set tidal volume, the inspiratory support will increase.

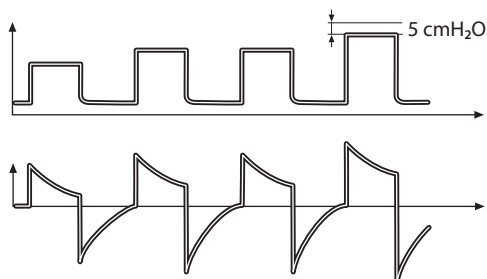

The initial breath provides support with 5 cmH<sub>2</sub>O.

Following this breath, the ventilator system calculates and continuously regulates the pressure needed to deliver the preset tidal volume.

An alarm is activated if the set target volume cannot be delivered due to the fact that the pressure required to deliver it is higher than 5 cmH<sub>2</sub>O below the set upper pressure limit.

In this mode it is also important to set the apnea time that is appropriate to the individual patient's situation. If this time is reached, the ventilator system will automatically switch to backup ventilation.

**Note:** For the neonatal patient category, activated leakage compensation ensures volume delivery at the level set.

Refer to section Leakage compensation on page 119.

### 5.7.1 Volume Support in detail

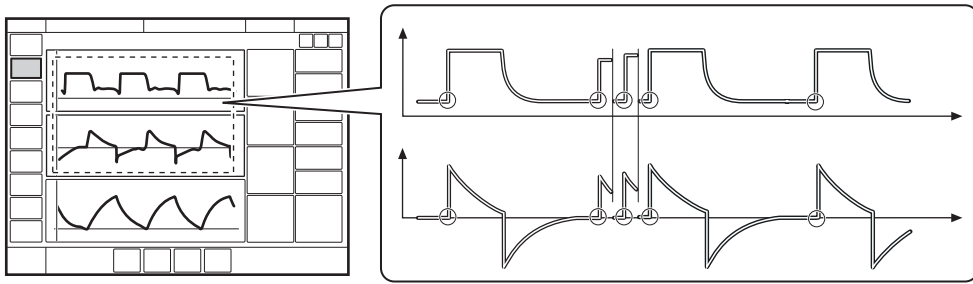

The circles in the figure indicate patient triggering.

- VS ensures delivery of a set target tidal volume following patient effort by providing inspiratory pressure support that is adapted to the patient.
- The inspiratory pressure level is constant during each breath, but alters in small increments, on a breath-by-breath basis, to match the patient's breathing ability and the mechanical properties of the lungs.
- Inspiration starts when the patient triggers.

#### Expiration starts:

- When the inspiratory flow decreases below a preset fraction of the peak inspiratory flow (*End inspiration*)
- If the upper pressure limit is exceeded
- If the maximum time for inspiration is exceeded  
Refer to section Functions in ventilation modes on page 193.
- If the flow drops to a range between 25 % of peak flow and the lower limit for End inspiration, and remains within the range for a period longer than 50% of the time elapsing between inspiration start and the point when the range was entered.

## 5.8 NAVA

### 5.8.1 Introduction

Neurally Adjusted Ventilatory Assist (NAVA) is a supported mode of ventilation based on the electrical activity of the diaphragm (Edi). NAVA is available for both invasive and non invasive use.

NAVA delivers assist in proportion to and synchronized with patient breathing efforts.

Refer to section NIV NAVA on page 101.

NAVA requires the insertion of an Edi catheter which monitors the Edi in all modes and in Standby.

The Edi catheter is a single-use feeding tube with measuring electrodes positioned in the esophagus so that the measuring electrodes span the movement of the diaphragm.

Refer to section NIV NAVA on page 101.

### 5.8.2 Before use

The following safety guidelines apply both to NAVA and NIV NAVA, unless otherwise stated.

#### **WARNINGS!**

- The Edi catheter and guide wire are for single use only. Reprocessing will degrade biocompatibility and/or cleanliness. Each Edi catheter may be used for up to 5 days.
- The Edi catheter must be removed from the patient before an MR examination. Due to the metallic electrodes:
  - The strong magnetic and RF fields could generate heat in the electrodes.
  - Artifacts (distortions) may appear in the MR images.

#### **Important:**

- In order for NAVA to be used, the patient must have an active respiratory drive. The drive can be inhibited by hyperventilation, sedation and muscle relaxants and thereby prevent NAVA ventilation.
- If the respiratory drive does become inhibited, the Edi catheter can stay in place for Edi monitoring until the Edi signal is re-established and it is again possible to ventilate with NAVA.
- Ensure that the electrical connector on the Edi catheter does not get wet. This may result in degradation of the function.
- The feeding lumen of the Edi catheter is slightly smaller compared to the feeding lumen of a standard feeding tube of the same size; this must be taken into consideration especially for 6 and 8 Fr Edi catheters.

- When ventilating patients weighing less than 3 kg in NIV NAVA ensure adequate external monitoring (e.g. SpO<sub>2</sub> or CO<sub>2</sub> monitoring).
- In NIV NAVA, small tidal volumes in combination with high leakage reduce the accuracy of expiratory measurements.

**Notes:**

- External equipment (e.g. heating blankets) may cause disturbances in the Edi signal.
- Continuous movement of the Edi catheter (e.g. against another person's body when holding a baby in kangaroo position) may cause disturbances in the Edi signal.
- When ventilating with NAVA be observant of patients with indwelling electrical devices, such as pacemakers or implanted defibrillators, as they may interfere with the Edi signal.
- When using a defibrillator this may interfere with the Edi signal.
- All disposable parts must be discarded according to hospital routines and in an environmentally safe way.

**5.8.3 System overview**

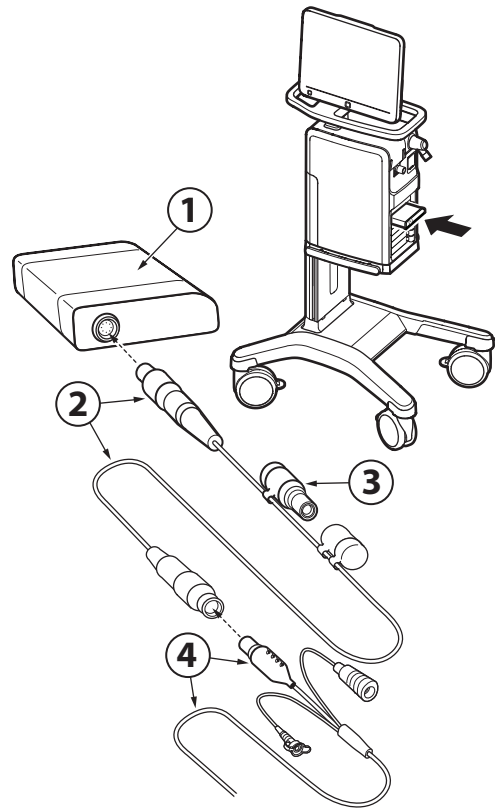

1. Edi module: the interchangeable plug-in Edi module slots into the module compartment in the ventilator system.
2. Edi cable and connector
3. Edi test plug
4. Edi catheter and connector

### 5.8.4 Workflow

#### Notes:

- Always perform a visual inspection of the equipment before use.
  - The procedure described here applies when switching to NAVA from another ventilation mode.
- Insert the Edi module and Edi cable into the ventilator system.
  - Test the Edi module and Edi cable with the test plug.
  - Select appropriate Edi catheter size for the patient according to the package labelling or as shown in the window opened by tapping *NAVA/CALCULATION TOOL*.
  - Estimate the length of Edi catheter to be inserted into the patient or follow the instructions in the *CALCULATION TOOL* window.
  - Dip the Edi catheter in water for a few seconds.
  - Insert the Edi catheter into the patient to the estimated length.
  - Plug the Edi catheter cable connector into the Edi cable.
  - Position the Edi catheter according to the procedure described on page 85.
  - Check the position of the Edi catheter as a feeding tube according to hospital routines and secure it to the patient.
  - Set the initial NAVA level.
  - Select NAVA or NIV NAVA, set all parameters, adjust the alarm limits and start NAVA or NIV NAVA ventilation.
  - Check that the cables are safely positioned.

### Insert Edi module into patient unit

**Important:** If the Edi module is dropped on the floor, contact a service technician to perform a leakage current check.

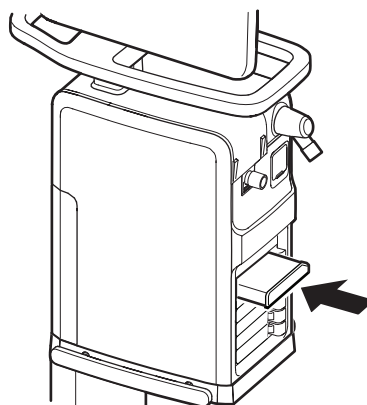

**Note:** Do not insert two Edi modules at the same time. The ventilator system can only handle one Edi module at a time.

Insert the Edi module into a free slot in the module compartment on the patient unit. Make sure it clicks into place.

## Edi module test

- Connect the Edi cable to the Edi module: hold the ribbed part of the connector (with the white marks to the right) and insert into the port.

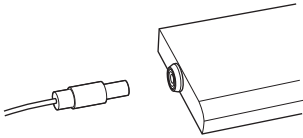

- Remove the cap from the test plug and connect the test plug to the other end of the Edi cable. The *Edi MODULETEST* will then start automatically.
- Wait until the dialog *Edi module test passed* is displayed on the screen.  
If the test fails, replace the Edi cable and/or Edi module and re-run the test.  
To remove the Edi cable, hold the ribbed part of the connector and pull gently to release.
- Tap *OK*, remove the test plug and replace the cap.

## Before inserting Edi catheter

**Important:** Always use the appropriate Edi catheter size for the patient as electrode placement is optimized for different patient sizes.

**Note:** Follow hospital hygiene routines for the handling of nasogastric tubes when handling the Edi catheter. The Edi catheter is packed sterile.

- Use the package labelling to select the correct Edi catheter. Verify, by visual inspection, that the package and the Edi catheter are undamaged.
- Measure the distance from the bridge of the Nose (N) via the Earlobe (E) to the Xiphoid process (X). This is referred to as the NEX measurement.

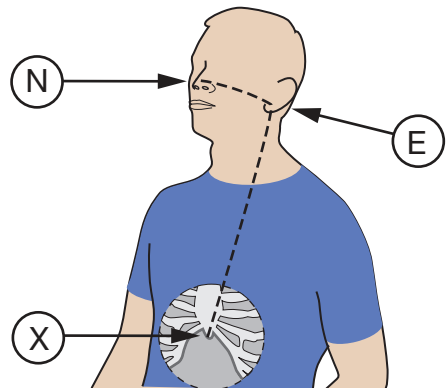

- Open the *CALCULATION TOOL* window and follow on-screen instructions to obtain a correct calculation of the catheter insertion distance.



## Insert Edi catheter

**WARNING!** Never re-insert or manipulate the guide wire once the Edi catheter has entered the patient, otherwise the guide wire may penetrate a feeding hole.

### Important:

- Do **not** apply any other substance than water to the Edi catheter. Lubricants, gels or solvents may destroy the coating and the contact with the electrodes.
- When the Edi catheter is inserted into the esophagus, do not insert any other probe or feeding tube.
- If a guide wire is needed, only use a guide wire for Edi catheters from Maquet.

**Note:** Make sure that the connector to the Edi catheter cannot hurt the patient by making sure that it is placed in an appropriate position.

- If a guide wire is used, follow the directions in the package insert for the guide wire.
- Dip the Edi catheter in water for a few seconds to activate its lubrication prior to insertion, avoiding wetting the connectors.
- Insert the Edi catheter nasally or orally and advance it down the esophagus to the calculated Y length.

## Position Edi catheter and set NAVA level

**Important:** As soon as the Edi catheter position is checked and verified, it is important to attach the Edi catheter securely to the patient.

**Note:** The procedure described here applies when switching to NAVA from another ventilation mode.

- Connect the Edi catheter to the Edi cable.

**Note:** To prevent contamination of the Edi catheter cable connector, always keep the protective cap on the connector when it is not connected to the ventilator system.

- Open the *Edi CATHETER POSITIONING* window.

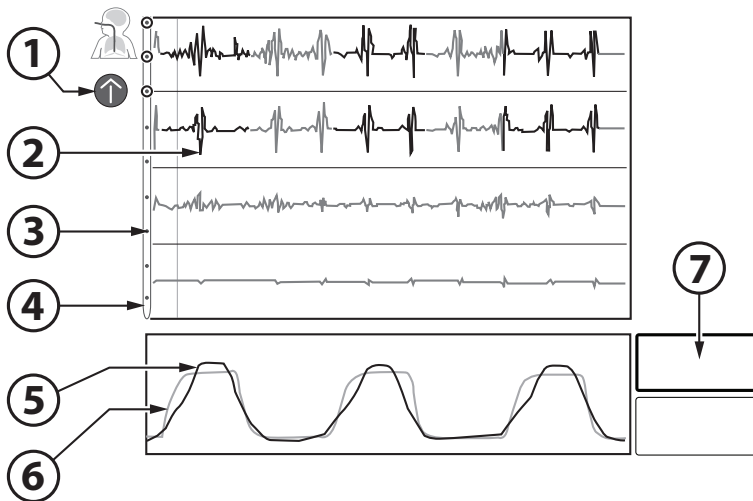

1. Catheter positioning guide - arrows (not visible when catheter position is correct) under the patient symbol show in which direction the catheter position should be finetuned
  2. ECG leads
  3. Edi catheter electrode
  4. Edi catheter
  5. Estimated pressure based on the Edi signal ( $P_{est}$ )
  6. Pressure (delivered to patient)
  7.  $Edi_{peak}$
- Check the position of the Edi catheter by means of the ECG waveforms:
    - Verify that P and QRS waves are visible in the top leads and decrease in the lower leads and that the P waves disappear in the lowest lead.
    - If the leads highlighted in pink are in the center during an inspiration, i.e. the second and third leads, the Edi catheter is aligned correctly and ready to be secured. There will then be no catheter positioning arrow visible to the left of the top ECG leads.
    - If it is not already aligned correctly, adjust the Edi catheter position:
      - If the top leads are highlighted in pink, pull out the Edi catheter in small steps of between 0.5-1.5 cm each depending on catheter size, until the pink highlights appear in the middle leads. Do not exceed four such steps.
      - A positioning arrow pointing upwards will also be visible to the left of the top ECG leads. This indicates that the catheter should be carefully moved upwards.

Both the symbols on the representation of the Edi catheter and the color highlights on the leads show where the Edi signal is strongest. If no Edi signal is detected, there will be no such indications. Note that the color highlights on the leads change more rapidly than the symbols on the Edi catheter.

- If the bottom leads are highlighted in pink, insert the Edi catheter further in similar steps until the pink highlights appear in the center. Do not exceed four steps.
- A positioning arrow pointing downwards will also be visible to the left of the top ECG leads. This indicates that the catheter should be carefully moved downwards.

**Important:** The positioning arrows can only be used to finetune the catheter position when there is a reliable Edi signal. If the Edi signal is low or absent, the arrows should not be used to adjust the catheter position.

- Make a note in the patient's file of the actual length inserted and mark this on the Edi catheter and/or enter it on the screen as the final distance.
- Secure the Edi catheter, being careful not to manipulate or move it in order to avoid interference with Edi monitoring.
- Check the pressure waveform (yellow) and the Pest waveform (gray) at the bottom of the positioning window. The two should be in synchrony and should preferably be approximately the same height.
- Check the Edipeak value to the right of the waveforms.  
If the Edipeak is consistently below 5  $\mu\text{V}$ :
  - Verify that the effects of muscle relaxants have worn off.
  - Verify the patient's sedation level. The apneic threshold might be higher due to CNS depressant drugs.

- Verify, by means of blood gas samples or by checking end tidal  $\text{CO}_2$ , that the patient is not hyperventilated, as this may affect the Edi signal. An example of this is if the support level is set too high.

**Note:** If the Edi is not synchronized with pressure and flow, this may mean that the Edi catheter is displaced and registering the electrical activity of another muscle. This will be indicated by the *Inconsistent Edi signal* alarm for NAVA and the *Edi signal invalid* alarm for NIV NAVA.

- Check the position of the Edi catheter as a feeding tube according to hospital routines.

**Important:**

- Never switch to NAVA ventilation if the Edi deflection is inconsistent or out of phase with the pressure and flow waveforms.
- Never switch to NAVA ventilation if no Edi activity is observed.
- Set the alarm limits and apnea time to relevant values to provide adequate patient safety.
- When not in use, it is recommended that the feeding lumen is covered in order to avoid incorrect use.
- If the Edi catheter is not connected to the ventilator system, do not touch the Edi catheter connector during defibrillation.
- Tap *NAVA level* and set an appropriate level.

- Verify that the Edi scale is fixed. The scaling function is accessed by tapping and holding the Edi waveform. The recommended level is 20  $\mu\text{V}$ . Set a sufficiently high upper limit on the scale where the Edi signal is not fully visible.

### **5.8.5 Using NAVA invasively**

NAVA:

- ventilation is controlled by the patient via the Edi, the Electrical activity of the diaphragm;
- delivers assist in proportion to and synchronized with patient breathing efforts;
- requires the insertion of an Edi catheter which monitors the Edi signal in all modes, therapies and in Standby;
- the pressure curve in NAVA follows the pattern of the Edi during inspiration;
- the inspiratory pressure of a breath will not exceed 5  $\text{cmH}_2\text{O}$  below the upper pressure limit;
- provides backup (PC) ventilation in case of apnea.

## Ventilating with NAVA

**Important:** Before switching to NAVA ventilation, all settings including backup settings must be set to achieve adequate ventilation.

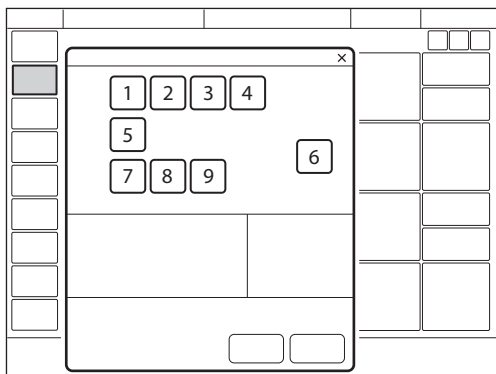

The following parameters are set:

Basic settings:

1. Oxygen concentration (%)
2. PEEP (cmH<sub>2</sub>O)
3. NAVA level
4. Edi trigger

PC backup settings:

5. Trigger
6. Apnea time (s)
7. Backup respiratory rate (b/min)
8. Backup PC above PEEP (cmH<sub>2</sub>O)
9. Backup I:E or Ti (s)

Refer to section Important settings on page 108.

### 5.8.6 NAVA ventilation in detail

NAVA is a patient-initiated breathing mode in which the breathing support is triggered by the patient's Edi signal.

NAVA also employs a pneumatic trigger, based on flow or pressure, as a secondary trigger source.

In combination with the Edi trigger, this operates on a first-come-first-served basis.

#### Inspiration starts:

When the patient triggers a breath, gas flows into the lungs at a varying pressure proportional to the patient's Edi.

#### Expiration starts:

- When the Edi decreases below 70 % of the peak value (during the ongoing inspiration).
- If the pressure increases 3 cmH<sub>2</sub>O above the inspiratory target pressure. During the part of the inspiration where the Edi is continuously increasing, higher pressure above the pressure target is temporarily allowed.
- If the upper pressure limit is exceeded.
- If the maximum time for inspiration is exceeded

Refer to section Functions in ventilation modes on page 193.

## 5.9 Automode

In Automode, the ventilator system shifts automatically between controlled and supported ventilation, allowing better patient-ventilator interaction. When the patient is making a breathing effort, the ventilator system immediately switches to a supported mode of ventilation. If the patient is not making any breathing effort, the ventilator system will return to the controlled mode and deliver controlled breaths.

The parameters for each Automode combination are adjusted in the settings window and are basically the same as those for the relevant controlled or supported mode. Refer to section Important settings on page 108.

### 5.9.1 Automode PC ⇌ PS:

- is an interactive mode automatically switching between the controlled mode PC and supported mode PS based on patient triggering;
- delivers controlled breaths in the absence of patient breathing effort, switching to supported breaths when a breathing effort is detected;
- serves as an aid to starting the weaning period;
- adapts to the patient's breathing capacity.

### 5.9.2 Automode PRVC ⇌ VS:

- is an interactive mode automatically switching between the controlled mode PRVC and supported mode VS based on patient triggering;
- delivers controlled breaths in the absence of patient breathing effort, switching to supported breaths when a breathing effort is detected;
- serves as an aid to starting the weaning period;
- adapts to the patient's breathing capacity.

### 5.9.3 Automode VC ⇄ VS:

**Note:** Automode VC ⇄ VS is not available in the neonatal patient category.

- is an interactive mode automatically switching between the controlled mode VC and supported mode VS based on patient triggering;
- delivers controlled breaths in the absence of patient breathing effort, switching to supported breaths when a breathing effort is detected;
- serves as an aid to starting the weaning period;
- adapts to the patient's breathing capacity.

In this combination, the ventilator system uses the plateau pressure in the VC breath as a reference pressure for the first VS breath.

Refer to sections Flow adaptation on page 70 and Decelerating flow on page 70.

### 5.9.4 Automode in detail

1. The ventilator system starts in PC, PRVC or VC mode. If the patient triggers a breath, the ventilator system will turn to the relevant supported mode to encourage the patient's respiratory drive.
2. If the patient is breathing adequately:
  - a. In VS, the ventilator system adjusts the inspiratory pressure level on a breath-by-breath basis to ensure delivery of the preset target volume.
  - b. In PS, the ventilator system ensures that the preset inspiratory pressure level is maintained throughout inspiration.
3. The ventilator system initially adapts with an increasing apnea time. This means that for the spontaneously triggering patient, the apnea time increases successively until the level set in the settings window for the maximal apnea time parameter is reached after 10 consecutive spontaneously triggered breaths. Refer to section Important settings on page 108.
4. Exceeding the maximal apnea time setting without a sufficient patient effort will cause the following:
  - a. In VS, a PRVC or VC breath will be delivered according to the selected Automode functionality.
  - b. In PS, a PC breath will be delivered.

### PC ⇌ PS

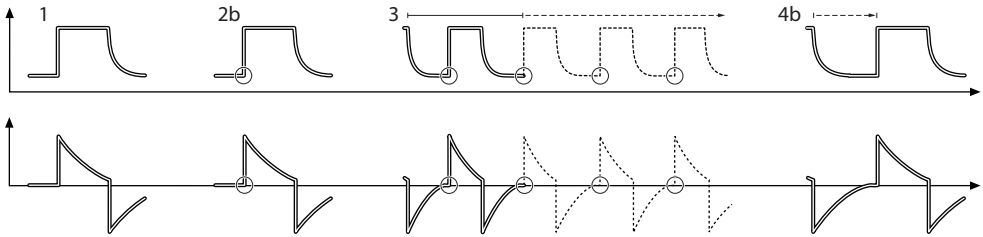

The circles in the figure indicate patient triggering.

### PRVC ⇌ VS

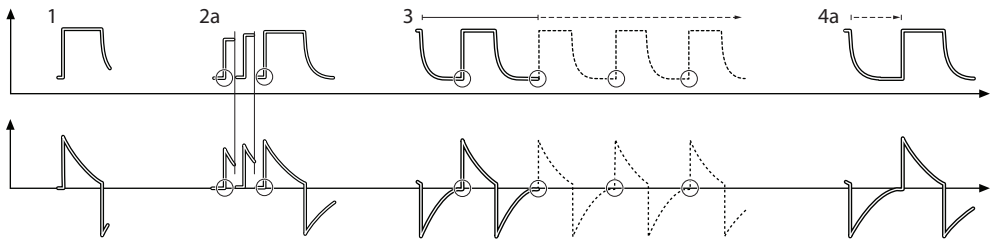

The circles in the figure indicate patient triggering.

### VC ⇌ VS

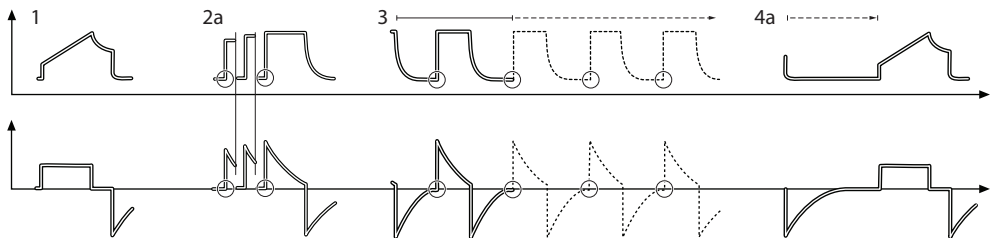

The circles in the figure indicate patient triggering.



## 5.10 SIMV

SIMV stands for Synchronized Intermittent Mandatory Ventilation. In SIMV modes, mandatory controlled ventilation breaths are delivered with a preset SIMV rate. The patient can breathe spontaneously with PS between the mandatory breaths.

The parameters for each SIMV combination are adjusted in the settings window and are basically the same as those for the relevant controlled or supported mode.

Refer to section Important settings on page 108.

### 5.10.1 SIMV (PC) + PS:

- delivers mandatory controlled breaths using a preset respiratory rate and a preset pressure;
- delivers inspiratory support (PS) during spontaneous breaths taken between the mandatory breaths.

### 5.10.2 SIMV (PRVC) + PS:

- delivers mandatory controlled breaths using a preset respiratory rate and a preset volume;
- delivers inspiratory support (PS) during spontaneous breaths taken between the mandatory breaths.

### 5.10.3 SIMV (VC) + PS:

**Note:** SIMV (VC) + PS is not available in the neonatal patient category.

- delivers mandatory controlled breaths using a preset respiratory rate and a preset volume;
- delivers inspiratory support (PS) during spontaneous breaths taken between the mandatory breaths.

In SIMV modes, the mandatory breath is defined by the basic settings.

|                              | SIMV (PC) + PS | SIMV (PRVC)+PS | SIMV (VC)+ PS  |
|------------------------------|----------------|----------------|----------------|
| PC above PEEP                | X              | —              | —              |
| Tidal volume /Minute volume  | —              | X              | X              |
| SIMV rate                    | X              | X              | X              |
| Breath cycle time            | X <sup>1</sup> | X <sup>1</sup> | X <sup>1</sup> |
| I:E ratio / Inspiration time | X              | X              | X              |
| Insp. rise time              | X              | X              | X              |
| Pause time                   | —              | —              | X <sup>1</sup> |

<sup>1</sup> Only when the ventilator system is configured for setting the I:E ratio.

**Note:** In the minute volume configuration, the tidal volume is determined by dividing the minute volume by the SIMV rate.

The breath cycle time is the length of the mandatory breath in seconds and is the same as the duration of an SIMV period.

In SIMV, the very first breath is always a mandatory one.

If the patient triggers a breath during the SIMV period, the breath delivered is a mandatory one. If the patient fails to trigger a breath within the first 90 % of the SIMV period, a mandatory breath is delivered.

**Note:** If the ventilator system is configured for setting the inspiration time, an I:E ratio of 1:2 will be used to estimate the breath cycle time.

The spontaneous/Pressure Support breaths are defined by setting the level for Pressure Support above PEEP (PS above PEEP).

#### 5.10.4 SIMV in detail

- This combination of controlled and supported ventilation allows for preset mandatory breaths that are synchronized with the patient's breathing.
- If there is no trigger attempt within a time window equal to 90 % of the set breath cycle time, a mandatory breath is delivered (the breath cycle time is the total time for one mandatory breath).
- The mandatory breath is defined by the basic settings (mode of ventilation, breath cycle time, respiratory pattern and volumes/pressures).
- The spontaneous/supported breaths are defined by the setting for PS.

Refer to sections Flow adaptation on page 70 and Decelerating flow on page 70.

### 5.10.5 SIMV (PC) + PS

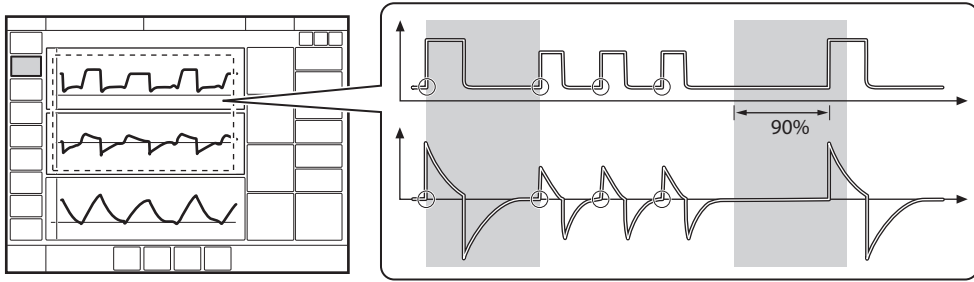

The circles in the figure indicate patient triggering.

### 5.10.6 SIMV (PRVC) + PS

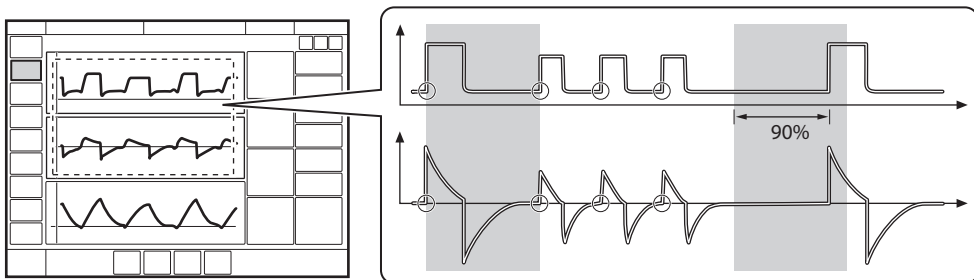

The circles in the figure indicate patient triggering.

### 5.10.7 SIMV (VC) + PS

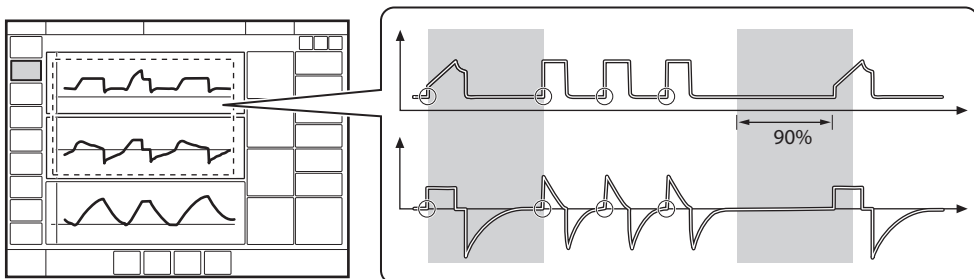

The circles in the figure indicate patient triggering.

## 5.11 Non Invasive Ventilation (NIV)

### 5.11.1 Introduction

NIV refers to ventilation when the patient is not intubated or tracheotomized. It involves the use of a patient interface such as:

- nasal mask
- nasal prongs
- face mask
- total face mask
- endotracheal tube positioned above the vocal cords
- NIV helmet

In NIV, the ventilator system adapts to variations in leakage to maintain the required pressure and PEEP level. Excessive leakage will result in a high priority alarm. Ventilation will resume automatically if the leakage decreases. It can also be started manually by tapping *Resume ventilation* in the *LEAKAGE DETECTED* window that opens to inform about leakage.

**Note:** In NIV, flow and volume curves and the following measured values are compensated for leakage:  $VT_i$ ,  $VT_e$ ,  $MV_i$ ,  $MV_e$ .

Refer to chapter Alarm handling on page 145.

In all NIV modes including Nasal CPAP, there is an automatic detection of patient connection and disconnection – the NIV disconnection functionality. This ensures that ventilation starts in a comfortable manner when the patient interface is applied to the patient's face. It ensures that ventilation stops when the interface is removed, avoiding high air flows and alarms.

It is possible to configure the NIV disconnection functionality. The setting made here will ensure a constant disconnection flow while ventilation is paused (at a high flow or a low flow setting). It is also possible to disable the NIV disconnection functionality, which may result in high air flows and alarms.

Refer to chapter Service & Settings on page 163.

The NIV disconnection functionality is available in all NIV modes including Nasal CPAP.

### 5.11.2 Safety guidelines

#### WARNINGS!

- Avoid high inspiratory pressure as it may lead to gastric overdistension and risk of aspiration. It may also cause excessive leakage.
- The dead space will increase in NIV when using a mask or helmet.
- NIV is not intended to be used on intubated or tracheotomized patients.
- CO<sub>2</sub> measurement will be affected by mask/prongs leakage.
- In non invasive ventilation, the measured expired volume may be different from the actual volume exhaled by the patient due to leakage around the mask.

#### CAUTIONS:

- It is not recommended to use a nebulizer during NIV as the nebulized drug might come in contact with the patient's eyes in case of leakage.
- Mask/prongs leakage might affect nebulizer efficiency.

#### Important:

- The mask/prongs must be properly applied in order to minimize leakage.
- When selecting the mask/prongs, it is essential to consider such things as proper size and accurate adaptation to the patient.
- CO<sub>2</sub> rebreathing will increase in NIV when using a mask or helmet.

### 5.11.3 Using a NIV helmet

#### WARNINGS!

- The helmet application shall not be used with volume controlled modes.
- The helmet application must only be used with pressure supported ventilation in NIV.

#### Important:

- When using NIV PS or NIV NAVA, the filling of the helmet **must** be initiated by tapping *START VENTILATION* or *Resume ventilation* on the screen. This must also be done after disconnection.
- To secure a proper patient triggering function, the PEEP level should never be set below 3 cmH<sub>2</sub>O. When helmets with a safety valve are used, it is recommended to set a PEEP level of at least 5 cmH<sub>2</sub>O.
- Alarms related to volume are not reliable. To avoid nuisance alarms the alarm limits must be properly set.
- It is essential to set pressure alarms adequately.

It is possible to use a helmet for non invasive ventilation of patients between 10 and 250 kg. Only use the adult patient category when using a helmet.

**Note:** For instructions for the helmet application, refer to the manufacturer's instructions for use.

There are a few points to remember in order to use a helmet safely:

- Do **not** rely on flow and volume parameters.
- The volume in the helmet may cause delays in signals and patient triggering.
- Make sure that the helmet used eliminates CO<sub>2</sub> re-breathing.
- High pressure levels may affect the patient's ears and the flow may affect the patient's eyes.
- Patients may perceive the helmet application as noisy. A Servo Duo Guard filter used on the inspiratory side will reduce the noise level. The noise level may vary between different helmets.
- Do not use humidified ventilation gas as this will cause condensation on the helmet walls.
- Do not use nebulizers.

## 5.12 NIV Pressure Control (NIV PC)

### NIV PC:

- delivers a constant pressure over a preset inspiratory time and at a preset respiratory rate;
- delivers the inspiration with a decelerating flow;
- changes in lung or thorax resistance or compliance will affect the volume delivered;
- is leakage compensated.

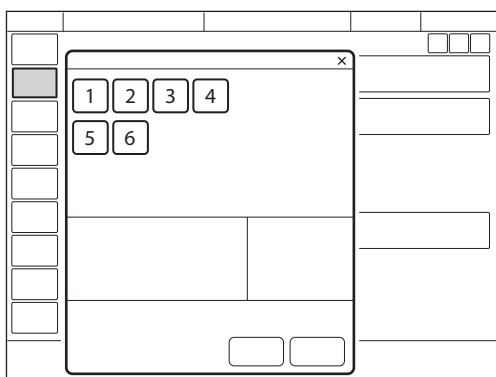

The following parameters are set:

1. Oxygen concentration (%)
2. PEEP (cmH<sub>2</sub>O)
3. Respiratory rate (b/min)
4. PC above PEEP (cmH<sub>2</sub>O)
5. I:E ratio or Inspiration time (s)
6. Inspiratory rise time (% or s)

Refer to section Important settings on page 108.

### Differences compared with invasive PC:

- When *START VENTILATION* is tapped, a waiting position dialog is displayed. All patient related alarms are turned off for 2 minutes. In this position, ventilation will start if the ventilator system detects patient activity.
- The trigger cannot be manually set in NIV.
- Detection of pressure below PEEP or expiratory volume decrease will start a new breath.

## 5.13 NIV Pressure Support (NIV PS)

**Note:** NIV PS is not available in the neonatal patient category.

NIV PS:

- is initiated by the patient, who controls the respiratory rate and tidal volume;
- delivers ventilator support using the preset pressure level and with a decelerating flow;
- has a fixed trigger;
- provides backup (PC) ventilation in case of apnea;
- is leakage compensated.

Differences compared with invasive PS:

- When *START VENTILATION* is tapped, a waiting position dialog is displayed. All patient related alarms are turned off for 2 minutes. In this position, ventilation will start if the ventilator system detects patient activity.
- The ventilator system will not lock in backup ventilation. There is no limit on the number of times the ventilator system can switch between supported mode and backup.
- The trigger cannot be manually set in NIV.

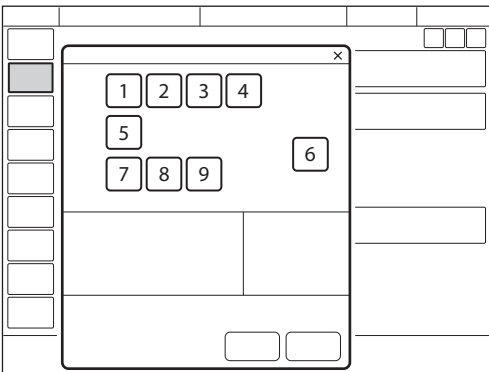

The following parameters are set:

1. Oxygen concentration (%)
2. PEEP (cmH<sub>2</sub>O)
3. PS above PEEP (cmH<sub>2</sub>O) (PS level)
4. End inspiration (%)
5. Inspiratory rise time (% or s)
6. Apnea time (s)
7. Backup respiratory rate (b/min)
8. Backup PC above PEEP (cmH<sub>2</sub>O)
9. Backup I:E or Ti (s)

Refer to section Important settings on page 108.



## 5.14 NIV NAVA

### NIV NAVA:

- ventilation is controlled by the patient via the Edi, the Electrical activity of the diaphragm;
- delivers assist in proportion to and synchronized with patient breathing efforts;
- requires the insertion of an Edi catheter which monitors the Edi signal in all modes, therapies and in Standby;
- the pressure curve in NAVA follows the pattern of the Edi during inspiration;
- the inspiratory pressure of a breath will not exceed 5 cmH<sub>2</sub>O below the upper pressure limit;
- provides backup (PC) ventilation in case of apnea.
- does not rely on a pneumatic signal for triggering and ending inspiration and is therefore independent of leakage and reduces the risk of autotriggering;
- is leakage compensated.

### 5.14.1 Ventilating with NIV NAVA

**Important:** Before switching to NIV NAVA ventilation, all settings including backup settings must be set to achieve adequate ventilation.

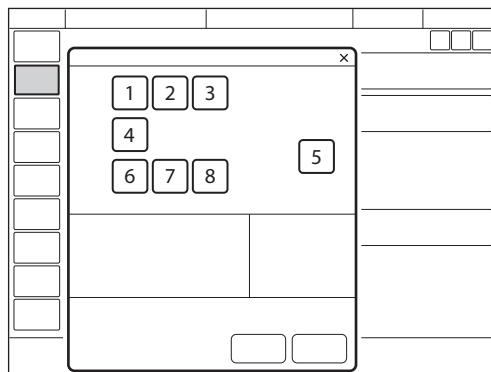

The following parameters are set:

#### Basic settings:

1. Oxygen concentration (%)
2. PEEP (cmH<sub>2</sub>O)
3. NAVA level
4. Edi trigger

#### PC backup settings:

5. Apnea time (s)
6. Backup respiratory rate (b/min)
7. Backup PC above PEEP (cmH<sub>2</sub>O)
8. Backup I:E or Ti (s)

Refer to section Important settings on page 108.

### 5.14.2 NIV NAVA in detail

#### Inspiration starts:

When the patient triggers a breath, gas flows into the lungs at a varying pressure proportional to the patient's Edi.

#### Expiration starts:

- When the Edi decreases below 70 % of the peak value (during the ongoing inspiration).
- If the pressure increases 3 cmH<sub>2</sub>O above the inspiratory target pressure. During the part of the inspiration where the Edi is continuously increasing, higher pressure above the pressure target is temporarily allowed.
- If the upper pressure limit is exceeded.
- If the maximum time for inspiration is exceeded

Refer to section Functions in ventilation modes on page 193.

### 5.15 Nasal CPAP

**Note:** Nasal CPAP is not available in the adult patient category.

Nasal Continuous Positive Airway Pressure:

- maintains a set continuous positive airway pressure via a non invasive nasal patient interface;
- delivers the flow necessary to maintain the set pressure;
- is leakage compensated;
- has a simplified alarm system with no apnea alarm, no respiratory rate alarm and no minute volume alarm.

Edi monitoring is available during Nasal CPAP.

Nasal CPAP is used when the patient is breathing spontaneously.

#### **WARNINGS!**

- When using Nasal CPAP, make sure that the airways are kept clear of mucus and debris.
- If nasal prongs are used, make sure that they are applied so that air can flow freely through both prongs.
- Patient effort and artifacts affecting patient flow or pressure, such as heart beats, movement of the patient circuit and intermittent leakage, may not always be correctly detected or discriminated. This may affect the accuracy of alarms and numerical values.
- Ensure adequate external monitoring for Nasal CPAP and High Flow therapy.

**Important:**

- The patient interface must be the appropriate size and also correctly adapted to the patient. In addition it must be properly applied in order to limit excessive leakage.
- CO<sub>2</sub> rebreathing will increase during Nasal CPAP if a nasal mask is used.

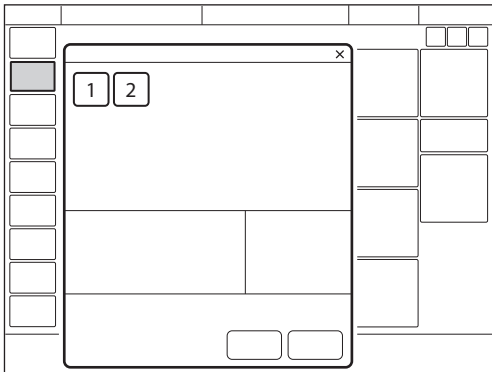

The following parameters are set:

1. Oxygen concentration (%)
2. CPAP (cmH<sub>2</sub>O)

Refer to section Important settings on page 108.

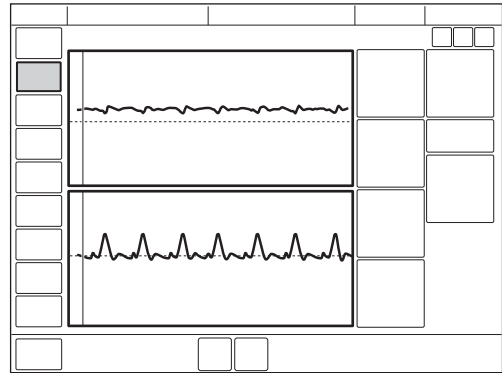

Differences compared with invasive CPAP:

- When *START VENTILATION* is tapped, a waiting position dialog is displayed. All patient related alarms are turned off for 2 minutes. In this position, ventilation will start if the ventilator system detects patient activity.
- Both triggering and termination of inspiration are automatically adapted to the leakage and cannot be set in Nasal CPAP.
- There is no backup ventilation available in Nasal CPAP.

## 5.16 High Flow therapy

High Flow therapy delivers a set flow of heated and humidified gas with a set concentration of oxygen to the patient. It can be selected in both invasive and non-invasive ventilation as well as in Standby.

**WARNING!** Ensure adequate external monitoring and an active humidifier during High Flow therapy.

- Always use only a high-flow nasal cannula of the appropriate size or a tracheostomy interface.
- The patient must be breathing spontaneously.
- High Flow therapy does not have the apnea alarm, respiratory rate alarm or minute volume alarm.
- Edi monitoring is available during High Flow therapy.

Refer to section Edi monitoring on page 121.

### 5.16.1 Start from Standby

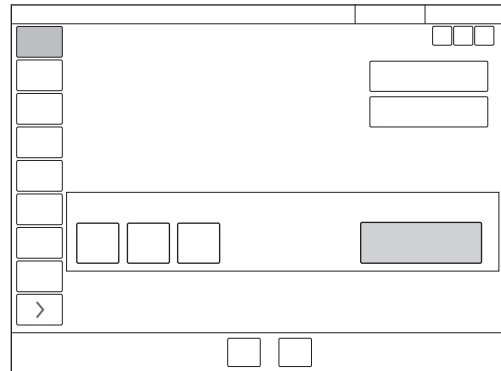

- Tap *MODES* in the quick menu
- Tap *HIGH FLOW / Other Therapies*.
- O<sub>2</sub> concentration and flow can be adjusted.
- Tap *Accept*.
- Connect the patient to the high flow nasal cannula or tracheostomy interface and tap *START HIGH FLOW* or wait two minutes and it will start automatically.

## 5.16.2 Starting during Ventilation

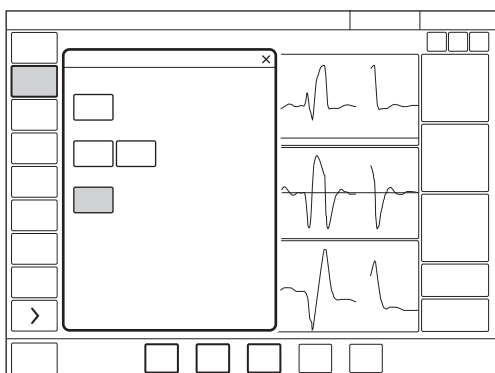

- Tap *MODES* in the quick menu
- Tap *HIGH FLOW / Other Therapies*.
- Tap *Continue*. This will stop ventilation and begin high-flow preparation.
- Ventilation is stopped and alarms are silenced for 2 minutes. The remaining time is shown on screen.
- High Flow therapy can be started manually when the preparation is complete and the interface is connected to the patient.



## 6 Ventilatory settings and functions

### Table of contents

|      |                                |     |
|------|--------------------------------|-----|
| 6.1  | Important settings             | 108 |
| 6.2  | O <sub>2</sub> concentration   | 108 |
| 6.3  | Tidal volume/Minute volume     | 108 |
| 6.4  | Pressure level                 | 108 |
| 6.5  | I:E ratio/Inspiration time     | 109 |
| 6.6  | End inspiration                | 110 |
| 6.7  | Inspiratory rise time          | 111 |
| 6.8  | Trigger                        | 112 |
| 6.9  | Apnea time                     | 115 |
| 6.10 | NAVA level                     | 115 |
| 6.11 | Driving pressure               | 116 |
| 6.12 | SIMV breath cycle time         | 116 |
| 6.13 | Settings-related information   | 116 |
| 6.14 | Maneuvers                      | 117 |
| 6.15 | Compensation functions         | 119 |
| 6.16 | Edi monitoring                 | 121 |
| 6.17 | Disconnection/Suction          | 122 |
| 6.18 | Previous mode                  | 125 |
| 6.19 | Apnea management               | 126 |
| 6.20 | Nebulization                   | 129 |
| 6.21 | CO <sub>2</sub> monitoring     | 135 |
| 6.22 | Using a Y sensor               | 140 |
| 6.23 | Adjust the O <sub>2</sub> cell | 143 |

## 6.1 Important settings

**Important:** If one or several settings in the mode settings window are highlighted in yellow, this indicates that it/they should be considered for adjustment, as the values entered there may have been carried over from the previous mode.

Refer to section Ventilatory settings on page 185.

## 6.2 O<sub>2</sub> concentration

The O<sub>2</sub> concentration delivered to the patient is set in the mode settings window and is monitored by the ventilator system with upper and lower alarm limits.

Refer to section Alarm limits on page 189.

The alarm is delayed 40 seconds after changing the O<sub>2</sub> concentration.

## 6.3 Tidal volume/Minute volume

Depending on the ventilator configuration, the inspiratory volume can be set as either:

- tidal volume or
- minute volume

Whichever of these is set, the other will be displayed in the lower right information area of the mode settings window.

## 6.4 Pressure level

PC above PEEP is the set inspiratory pressure level for each mandatory breath in:

- PC
- SIMV (PC) + PS
- Automode PC ⇌ PS
- backup ventilation in PS and NAVA

PS above PEEP is the set inspiratory pressure support level for triggered breaths in:

- PS
- all SIMV modes
- Automode PC ⇌ PS
- Bi-Vent/APRV

**Note:** SIMV (VC) + PS is not available in the neonatal patient category.



## 6.5 I:E ratio/Inspiration time

The setting of ventilatory settings can be configured in two different ways, based on:

- I:E ratio or
- inspiration time, in seconds, to better meet the requirements for neonatal and pediatric care.

### 6.5.1 I:E ratio

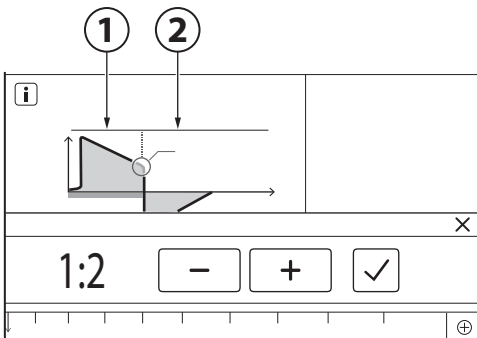

1. Inspiration
2. Expiration

The I:E ratio:

expresses the relation between the inspiration phase and the expiration phase. Spontaneous breathing has an I:E ratio of around 1:1.5.

Note that increasing the inspiration time may raise mean airway pressure and improve oxygenation but may also cause hyperinflation. Reversed I:E ratios (e.g. 1.5:1 or 2:1) will further lengthen inspiratory time and shorten expiration, which may be helpful if the lungs are very stiff, but requires low respiratory rates to avoid gas trapping.

A prolonged expiration time (e.g. 1:3) may be used for weaning and in case of obstructive lung disease, but a short inspiration time may also lower the tidal volume and lead to inadequate ventilation.

An inverse I:E ratio is also used in Bi-Vent/APRV mode.

Refer to section Bi-Vent/APRV on page 73.

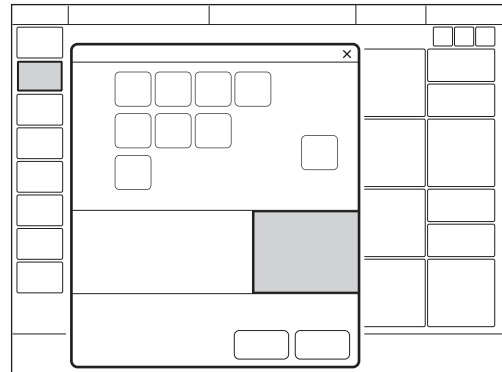

When the ventilator system is configured for setting of I:E, the unit for pause time and inspiratory rise time automatically switches to percent. The corresponding inspiration time for each I:E is displayed in the lower right information area of the mode settings window.

### 6.5.2 Inspiration time

The setting makes it possible to set the inspiration time ( $T_i$ ) to a fixed time in seconds.

With this configuration, the unit for inspiratory rise time and pause time automatically switches to seconds. The corresponding I:E ratio for each inspiration time setting is displayed in the lower right information area of the mode settings window.

As the inspiration time is explicitly set, a change in the respiratory rate, for example, will affect the I:E ratio. As a safety precaution, there will therefore be an indication when the resulting I:E ratio passes 1:1 in either direction.

**Note:** When the inspiration time is directly set, the breath cycle time parameter is not displayed when an SIMV mode is selected, since there is no need to set it.

### 6.6 End inspiration

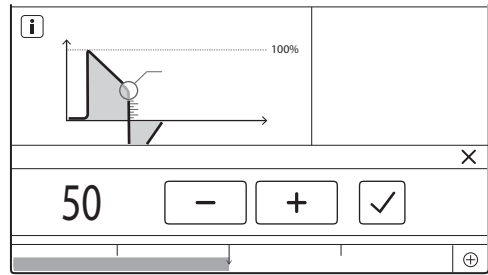

*End inspiration:*

- is the point at which inspiration changes to expiration in supported ventilation;
- if set too low, inspiration will be longer, which may cause pulmonary hyperinflation and increased work of breathing;
- if set too high, inspiration will be shorter, which may mean that the patient receives insufficient tidal volume.

## 6.7 Inspiratory rise time

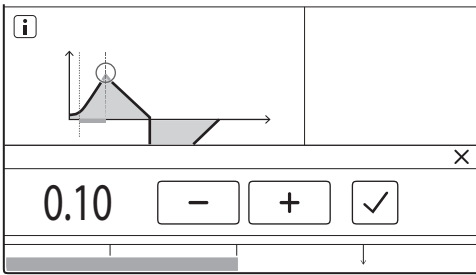

The inspiratory rise time ( $T_{insp.rise}$ ):

- is the time taken to reach peak inspiratory flow or pressure at the start of each breath;
- is expressed in seconds or as a percentage of the respiratory cycle time depending on how the ventilator is configured.

An increased inspiratory rise time will affect the rate of flow/pressure increase and can be evaluated by the shape of the flow and pressure waveforms.

In supported modes, the inspiratory rise time should normally be increased from the default setting to enhance patient comfort.

Inspiratory rise time set as a percentage is applicable in:

- VC
- PC
- PRVC
- all SIMV modes
- all Automode modes

**Note:** VC and SIMV (VC) + PS and Automode VC  $\rightleftharpoons$  VS are not available in the neonatal patient category.

Inspiratory rise time set in seconds is applicable in:

- PS
- VS
- Bi-Vent/APRV

**Note:** When the ventilator system is configured for setting of inspiration time rather than I:E ratio, the unit for inspiratory rise time automatically switches to seconds for all ventilation modes.

## 6.8 Trigger

The ventilator system has two trigger functionalities:

- a pneumatic trigger (flow or pressure based)
- an Edi trigger used in NAVA and NIV NAVA only

### 6.8.1 Pneumatic trigger

The pneumatic trigger setting:

- determines the level of patient effort needed to trigger the ventilator to inspiration;
- may be set as either flow or pressure triggering, where flow triggering allows the patient to breathe with less effort;
- should generally be set so that it requires minimal patient effort without causing autotriggering.

During expiration, the ventilator system continuously delivers a gas flow (bias flow), which is measured in the expiratory channel.

Refer to section Ventilatory settings on page 185.

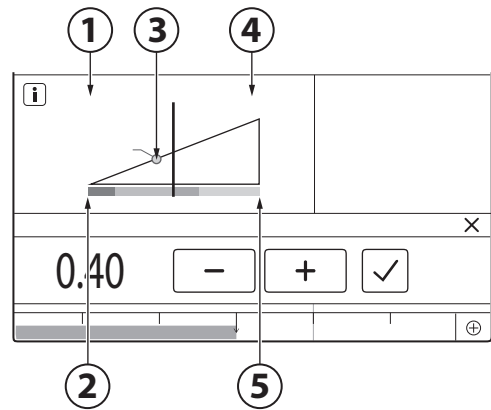

1. Flow
2. Less effort
3. Trigger setting
4. Pressure
5. More effort

When triggering is based on flow (1), to the left on the scale, the ventilator system senses deviations in the bias flow delivered during expiration. These deviations are caused by the inspiratory efforts of the patient.

When using a Y sensor, different conditions apply.

Refer to section Using a Y sensor on page 140.

The further to the left on the scale, the less effort (2) the patient has to make. At the far left of the scale, there is a risk of autotriggering, and the scale and value are therefore marked in red. The trigger setting (3) is marked with a circle in the dynamic image.

When triggering is based on pressure (4), to the right on the scale, the ventilator system senses deviations in the pressure below PEEP created by the patient. The pressure below PEEP required to initiate a breath is displayed when the setting is made.

The further to the right on the scale, the greater the patient effort (5) required to trigger.

The trigger scale has different colors based on the setting. Green indicates a normal setting for pneumatic triggering. Red indicates that the setting is not recommended, e.g. when the risk of self-triggering may increase. Yellow is used as a warning color.

**WARNING!** If the flow trigger level is very low (too far to the left on the scale), an autotriggering condition may be reached. This condition can also be reached if there is leakage in the patient circuit, e.g. if an uncuffed endotracheal tube is used. Triggering will then be initiated by the ventilator system and not by the patient. This should always be avoided by increasing the patient effort required to trigger the ventilator system, moving further to the right on the scale.

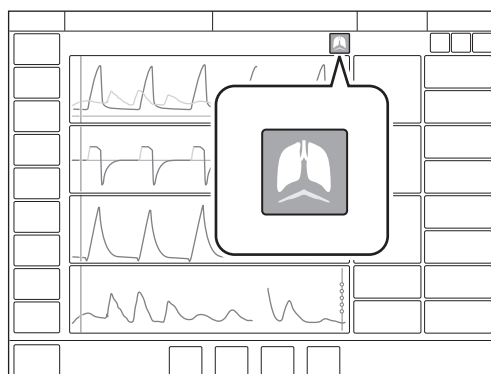

Patient triggering (flow or pressure) is indicated by a symbol in the status bar.

The pressure or flow curve will also be highlighted in white depending on which type of trigger is used.

### 6.8.2 Edi trigger

**Note:** The Edi trigger is only available in NAVA and NIV NAVA.

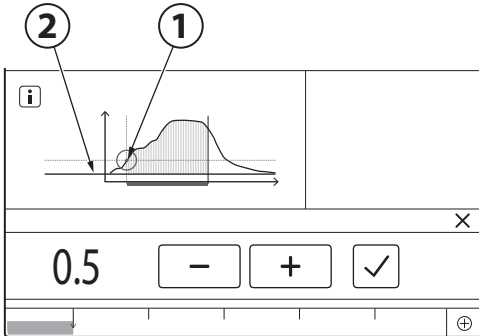

1. Edi trigger
2. Edimin

The Edi trigger setting selected specifies how much higher than Edimin the Edi needs to be before it will trigger the ventilator to assist the patient. It needs to exceed the level of background noise (typically  $< 0.5 \mu\text{V}$ ), and the default value of  $0.5 \mu\text{V}$  may as a rule be left unchanged. If it is set higher, the response time from the ventilator will be longer.

As a secondary source, NAVA also uses a pneumatic trigger based on flow or pressure. This operates together with the neural trigger on a first-come-first-served basis. If the value of the pneumatic trigger is set too low, there is a risk of autotriggering.

In NIV NAVA, the pneumatic trigger does not operate if leakage is higher than 60 %.

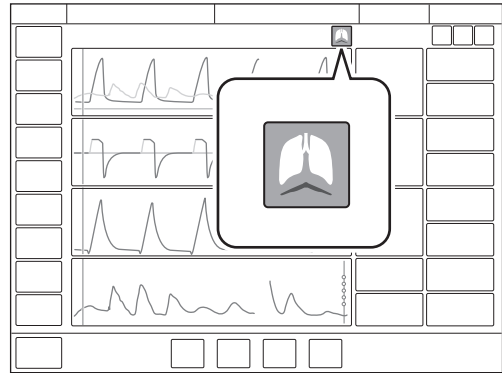

When the Edi trigger is active, a symbol will be visible in the status bar and the Edi waveform will also be highlighted in white.

## 6.9 Apnea time

*Apnea time* is the time without a patient breathing effort that the ventilator system will allow to elapse in supported ventilation before the *No patient effort* alarm is activated and the ventilator system switches to the backup mode.

The apnea time is also described in more detail in connection with backup ventilation. Refer to section Apnea management on page 126.

### 6.9.1 Maximal apnea time

In Automode, the apnea time becomes longer as spontaneous breathing becomes more regular. It is therefore set, in Automode only, as *Max. apnea time*.

The maximal apnea time:

- is the maximum time without a patient breathing effort that the ventilator will allow to elapse in supported ventilation before switching to controlled ventilation.

## 6.10 NAVA level

The NAVA level is the factor by which the patient's Edi signal is multiplied to adjust the amount of assist delivered. The pressure delivered is proportional to the patient's Edi and is calculated as:

- NAVA:  $P_{\text{peak}} = \text{NAVA level} \times (\text{Edi}_{\text{peak}} - \text{Edi}_{\text{min}}) + \text{PEEP}$
- NIV NAVA:  $P_{\text{peak}} = \text{NAVA level} \times (\text{Edi}_{\text{peak}} - \text{Edi}_{\text{min}}) + \text{PEEP} + 2 \text{ cmH}_2\text{O}$

The set NAVA level reflects the amount of work of breathing that the ventilator will take over from the patient. The appropriate NAVA level varies for each patient since they require different levels of unloading.

The higher the NAVA level, the more support the ventilator provides.

It should be noted that the patient's Edi signal normally decreases as the NAVA level increases.

If the NAVA level is set too high, the assist provided may cause the Edi to become low or irregular.

The lower the NAVA level, the less support the ventilator provides.

## 6.11 Driving pressure

Driving pressure ( $P_{\text{drive}}$ ) is the difference between the end-inspiratory pressure and the positive end-expiratory pressure.

$P_{\text{drive}}$  is displayed in following ventilation modes:

- VC
- PC
- PRVC

$P_{\text{drive}}$  is displayed in numerical values. The placement can be either in additional values or replacing  $P_{\text{mean}}$  depending on the configuration in *SERVICE & SETTINGS/BIOMED/CONFIGURATION*.

## 6.12 SIMV breath cycle time

The SIMV breath cycle time:

- is the duration of the total respiratory cycle of the mandatory breath in SIMV (inspiration + pause + expiration);
- only applies if the inspiratory time is set using the I:E ratio;
- together with a spontaneous period, makes up one full SIMV cycle.

The breath cycle time is sometimes referred to as an SIMV period.

**Note:** The breath cycle time parameter is not displayed when an SIMV mode is selected and inspiration time is configured.

## 6.13 Settings-related information

### 6.13.1 Predicted body weight (PBW)

**Notes:**

- For adult patients outside the height range 130-200 cm, PBW is the same as the patient weight (BW).
- For neonatal and pediatric patients, PBW is the same as the patient weight (BW).

In mechanical ventilation, predicted body weight can be used to help reduce the risk that differences in body weight will affect the estimated ventilation needs of different patients.

The ventilator monitors the ratio of tidal volume to PBW (VT/PBW) in ml/kg.

In the adult patient category PBW is calculated according to the Devine Formula and requires that height and gender are entered.

The tidal volume setting will, when tapped, present a calculated value for VT/PBW if the necessary patient data has been entered under *PATIENT DATA*. The value will also be presented in the numerical values and trended under *TRENDS & LOGS/TRENDS*



## 6.14 Maneuvers

The following four functions can be accessed under *MANEUVERS* (only available during ventilation) in the quick menu.

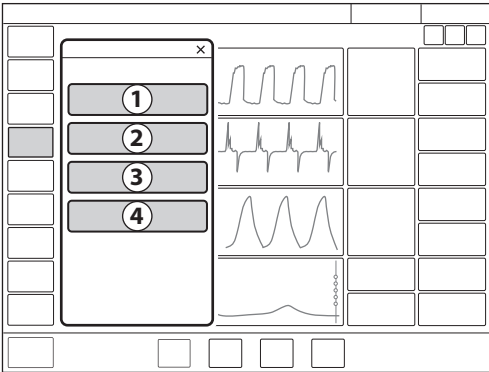

1. Manual breath
2. Static measurements
3. Nebulization
4. O<sub>2</sub> boost level

### 6.14.1 Manual breath

When *MANUAL BREATH* is tapped, the ventilator system will initiate a new breath cycle according to the current ventilator settings.

### 6.14.2 Static measurements

The inspiratory and expiratory hold can be used to perform certain measurements:

- PEEP<sub>tot</sub>: set PEEP + intrinsic PEEP
- C<sub>static</sub>: static compliance, a measure of the elastic properties of the respiratory system. A decrease in compliance implies stiffer lungs.
- E: elastance. There are different compliances and resistances in the lungs and an increase in elastance implies stiffer lungs.
- R<sub>i</sub>: inspiratory resistance.
- R<sub>e</sub>: expiratory resistance.
- T<sub>c</sub>: time constant, calculated as C<sub>static</sub> x R<sub>e</sub>. Some lung units have decreased compliance, and some have increased resistance, or both. Differences in R<sub>e</sub> and C<sub>static</sub> affect the speed at which the lung units are filled and emptied. An expiration time of three time constants is recommended to avoid auto PEEP.
- P<sub>plat</sub>: pressure during end inspiratory pause.

## Inspiratory hold

This function is activated by pressing *INSPIRATORY HOLD* for a maximum of 30 seconds. The inspiratory and expiratory valves close after inspiration. This function can provide an exact measurement of the end inspiratory lung pressure. It can be used to pause ventilation during X-ray or to determine the plateau pressure ( $P_{plat}$ ), or, together with the expiratory hold, to calculate static compliance.

## Expiratory hold

Expiratory and inspiratory valves are closed after the expiration phase is completed for as long as *EXPIRATORY HOLD* is pressed, but only up to a maximum of 30 seconds. Expiratory hold provides an exact measurement of the end expiratory pause pressure. It can be used to determine total PEEP and, together with inspiratory hold, static compliance ( $C_{static}$ ). The dynamic pressure is displayed on the PEEP numerical value.

### 6.14.3 Nebulization

Refer to section Nebulization on page 129.

### 6.14.4 O<sub>2</sub> boost level

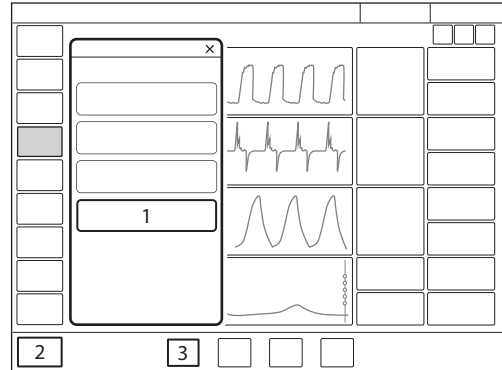

1. O<sub>2</sub> boost level
2. O<sub>2</sub> boost function
3. O<sub>2</sub> concentration setting (*O<sub>2</sub> conc.*)

By tapping *O<sub>2</sub> BOOST LEVEL* (1), it is possible to change the desired level for the O<sub>2</sub> boost function (2). It is possible to lock the O<sub>2</sub> boost level to 100 %. It is also possible to set it to 0 %, in which case the O<sub>2</sub> boost function (2) will no longer be active and will be replaced by three asterisks.

The value entered under *O<sub>2</sub> boost (%) level* specifies the number of percentage units that will be added to the value set for the O<sub>2</sub> concentration (3).

For example: if the current O<sub>2</sub> concentration is 40 % and the O<sub>2</sub> boost level is 30 %, the O<sub>2</sub> boost function will, when tapped, deliver 70 % O<sub>2</sub>.

The O<sub>2</sub> boost function figure displayed will change accordingly. Since the minimum O<sub>2</sub> concentration is 21 %, the *O<sub>2</sub> boost (%) level* scale goes from 0 to 79 %.

Refer to section Ventilatory settings on page 185 and to section Edit Temporary O<sub>2</sub> increase (%) on page 167.

### 6.14.5 O<sub>2</sub> boost function

To use the O<sub>2</sub> boost function, tap and hold O<sub>2</sub> *boost* at the bottom left corner of the screen.

When tapped, O<sub>2</sub> *boost* delivers the oxygen setting displayed here for a period of 1 minute. The O<sub>2</sub> boost function can be interrupted by tapping the red cancel symbol in the O<sub>2</sub> boost timer window anytime during the 1 minute interval.

## 6.15 Compensation functions

### 6.15.1 Leakage compensation

Leakage compensation is designed to help maintain PEEP throughout the breath and is activated by default.

When it is activated, the delivered and measured volume and flow values are automatically leakage compensated, as indicated by the symbols on the affected values.

Leakage is measured and presented in percent.

Leakage compensation may also affect important ventilatory parameters, such as patient triggering and the termination of inspiration.

### Invasive modes

In invasive modes, leakage compensation is only available in the neonatal patient category.

**Important:** In the neonatal patient category, leakage compensation can be activated or deactivated in all invasive modes except Bi-Vent/APRV. It must be turned off before Bi-Vent/APRV can be used.

An alarm will alert the user if leakage exceeds 60%.

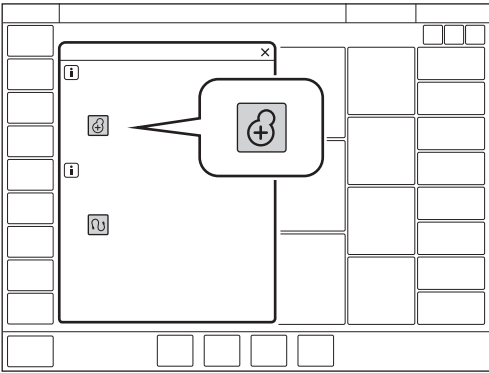

To deactivate or reactivate, tap *COMPENSATION* in the extended menu. Tap leakage compensation on. Follow on-screen instructions.

When leakage compensation is used in invasive modes such as PRVC and VS in the neonatal patient category, it ensures volume delivery at the level set.

### Non invasive modes

Leakage compensation is always active for all patient categories in non invasive modes.

*LEAKAGE COMPENSATION* disappears from the extended menu when NIV is selected.

### 6.15.2 Circuit compensation

Part of the volume of each inspiration will not reach the patient because of gas compression in the ventilator and expansion of the tubing. All components in the patient circuit affect such losses.

When circuit compensation is activated, the delivered and measured volume and flow values are automatically compensated for these losses, as indicated by the symbols on the affected values.

The patient circuit test must be passed in order to activate circuit compensation.

The patient circuit test measures resistance and compliance in the patient circuit. If the patient circuit is changed and no new patient circuit test is performed, the ventilator will compensate incorrectly for the previous patient circuit. If the correct circuit is not tested, the following risks may arise.

- In volume-based modes, the volume delivered to the patient will be incorrect.
- In pressure-based modes, the volume measured will be incorrect.

Refer to chapter Operation overview on page 37.

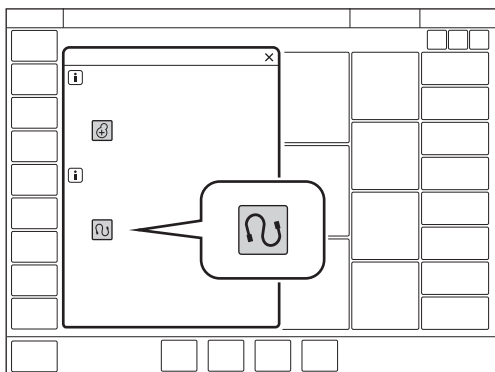

To deactivate or reactivate, tap *COMPENSATION* in the extended menu. Tap circuit compensation on. Follow on-screen instructions.

**Important:** When monitoring VT/PBW, circuit compensation must be activated.

## 6.16 Edi monitoring

**Note:** In order to use the Edi monitoring function, an Edi catheter and Edi module must be in place.

Refer to chapter NAVA on page 81.

The Edi/NAVA functionality makes it possible, if an Edi catheter is in place, to monitor Edi activity in all ventilation modes as well as in Standby.

The following description assumes that the appropriate equipment is connected.

- During ventilation, the Edi waveform will be displayed on the screen, and relevant  $Edi_{peak}$  and  $Edi_{min}$  values will also be displayed in the numerical values.

In addition, the estimated pressure curve ( $P_{est}$ ) is superimposed on the pressure waveform. To remove it, tap and hold the pressure or Edi waveform and then tap the  $P_{est}$  tile that is present in the window if an Edi module and Edi catheter are in place. The superimposition can be restored, if desired, by tapping the tile again.

- When ventilation is stopped by tapping *STANDBY* in the quick menu, there is a choice to *Stop ventilation* or *Stop ventilation and go to Edi monitoring*. The first choice will take the ventilator system to Standby, while the second goes directly to the *Edi MONITORING* window described here.

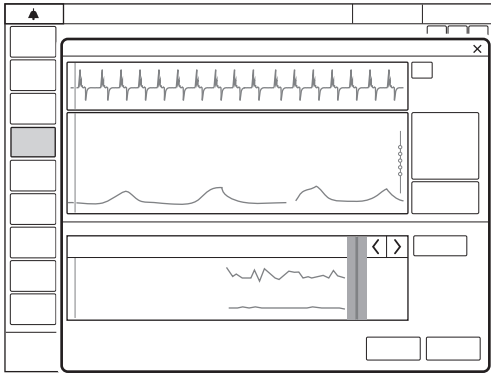

The Edi waveform will be displayed, together with numerical values for Edipeak and Edimin. A single ECG lead is also displayed above the Edi waveform, as well as the Edi trend in the lower half of the screen. *NAVA* is highlighted in the quick menu.

It is also possible to toggle between the *Edi CATHETER POSITIONING* window and the *Edi MONITORING* window by tapping either *Edi catheter positioning* or the *Edi catheter positioning* shortcut.

Even when ventilation has been stopped without going to *Edi monitoring* and the ventilator system is therefore in *STANDBY* it is possible to follow the Edi signal by tapping *Edi MONITORING* on the right of the screen.

## 6.17 Disconnection/Suction

Tap *DISCONNECTION/SUCTION* in the quick menu during ventilation to open the *DISCONNECTION/SUCTION* window.

The window always opens in *Preparation*.

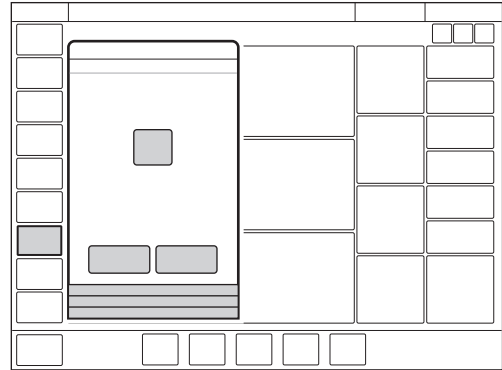

*DISCONNECTION/SUCTION* enables automatic inhibition of the ventilator system during a tracheal suction procedure or when briefly pausing ventilation in invasive modes. The ventilator system is prevented from cycling without activating alarms.

**Important:** Use *DISCONNECTION/SUCTION* for all disconnections of the patient circuit when ventilating in *NAVA* or in the neonatal patient category when leakage compensation is active.

Refer to section *Ventilatory settings* on page 185 and to section *Edit Temporary O<sub>2</sub> increase (%)* on page 167.

### 6.17.1 Suctioning procedures

**Important:** If a closed-suction system is used, *DISCONNECTION/SUCTION*, as well as the inspiratory and expiratory hold functions, should **not** be used.

#### OPEN SUCTIONING

For open suctioning procedures, there are three phases following *Preparation*:

- *Pre-oxygenation*
- *Patient disconnected*
- *Post-oxygenation*

**Important:**

- Alarms are turned off during the *Patient disconnected* phase for a maximum of 60 seconds. If the patient has not been reconnected within 60 seconds, alarms are activated.
- The minimum PEEP level during disconnection is 3 cmH<sub>2</sub>O. The ventilator system will adjust to the minimum level if the PEEP level is below 3 cmH<sub>2</sub>O in order to detect disconnection of the patient.

**Notes:**

- *DISCONNECTION/SUCTION* is not available in NIV modes or when *Manual breath* is activated.
- During the *Patient disconnected* phase of a suctioning procedure, the nebulizer is temporarily paused.
- When only one gas is connected, an elevated oxygen level cannot be set during the preparation phase. In this case, the post-oxygenation phase will be skipped.

Adjust the O<sub>2</sub> concentration, if desired, then tap *Accept*.

**Note:** Tapping *Cancel* will close the *DISCONNECTION/SUCTION* window.

- *Pre-oxygenation*

Pre-oxygenation of the patient begins automatically after *Accept* is tapped during preparation.

The *Patient circuit disconnected* alarm is turned off. The maximum duration of the pre-oxygenation phase is 120 seconds. After this, the system automatically returns to ventilation using the previous oxygen setting. The same thing happens if *Cancel* is tapped.

- *Patient disconnected*

The system automatically enters the *Patient disconnected* phase when the patient is disconnected during the pre-oxygenation phase.

During the *Patient disconnected* phase, the following alarms are turned off for up to 60 seconds:

- apnea
- minute volume
- respiratory rate
- etCO<sub>2</sub>
- PEEP

When the patient is reconnected, the system automatically enters the post-oxygenation phase and then resumes ventilation. It is also possible to restart ventilation manually by tapping *START VENTILATION*.

- *Post-oxygenation*

After reconnection, the ventilator system will deliver the same oxygen concentration as in the pre-oxygenation phase for 60 seconds.

After 60 seconds the system automatically returns to ventilation using the previous oxygen concentration setting.

## **CLOSED SUCTIONING**

When using a closed-suction system, *DISCONNECTION/SUCTION* should not be used. The O<sub>2</sub> boost function should be used instead for oxygenation purposes. Consider pre-silencing the alarms before suctioning.

Use one of the pressure-based modes listed here. Adjust settings to levels suitable for the patient and follow hospital guidelines for closed suctioning.

- PC
- PS
- Bi-Vent/APRV
- SIMV (PC) + PS
- NAVA



## 6.18 Previous mode

When *MODES* is tapped in the quick menu during operation, the current mode tile is always highlighted and the previous mode tile is marked with an arrow. The date and time for the switch to the present mode is shown in the bottom of the *MODES* window.

**Note:** If the previous mode was non invasive and the current mode is invasive, or vice versa, it is necessary to go to Standby and choose the relevant ventilation type to find the previous mode.

To recall the previous ventilation mode used:

- Tap the tile marked with an arrow in the *MODES* window.
- A dialog will open asking *Do you want to keep the previous settings for the mode?*
- Tap one of the two choices *Yes* or *No* as appropriate.
  - If *Yes* is tapped, the mode settings window will open with the previous settings intact.

**Important:** If one or several settings in the mode settings window are highlighted in yellow, this indicates that it/they should be considered for adjustment, as the values entered there may have been carried over from the previous mode.

- If *No* is tapped, the mode settings window will open with default settings, which may then be adjusted.

### Notes:

- The previous mode function is not available:
  - after a pre-use check
  - after changing the patient category
  - after admitting a new patient
  - after using the same ventilation mode for more than 24 hours
  - after restarting the system.
- When the previous mode function is activated during backup ventilation, the ventilator system returns to the mode that was active before the supported mode was initiated.
- A recall of previous settings is only possible after a change of ventilation mode.

## 6.19 Apnea management

### 6.19.1 Apnea time

*Apnea time* is the time without a patient breathing effort that the ventilator system will allow to elapse in supported ventilation before the *No patient effort* alarm is activated and the ventilator system switches to the backup mode.

The relevant backup mode is highlighted in white in the heading on the screen and the alarm *No patient effort* is displayed.

If the patient triggers a breath, the ventilator system automatically switches back to supported ventilation and the *No patient effort* alarm disappears.

Apnea time is available in all supported modes (not applicable in Nasal CPAP) and in all SIMV modes. Set the apnea time that is appropriate for each patient in the mode settings window.

**Note:** In SIMV modes, there is no backup ventilation and the apnea time only controls the *No patient effort* alarm. The apnea time is therefore set in the *ALARM LIMITS* window.

In the neonatal patient category only, the *No patient effort alarm* can be turned off in NAVA and NIV NAVA.

Refer to chapter Alarm handling on page 145 and to section Alarm limits on page 189.

### 6.19.2 Backup ventilation

For invasive modes, backup ventilation entails a switch in case of apnea:

- from VS to PRVC
- from PS/CPAP and NAVA to PC.

For non invasive modes, the switch is from NIV PS and NIV NAVA to NIV PC.

When the relevant backup mode is activated while ventilating in a supported mode, the name of the mode is highlighted in white in the mode heading and the backup parameters in the direct access bar are shown as active.

The following parameters are set under the backup mode heading in the mode settings window:

- PC above PEEP (cmH<sub>2</sub>O) for PS and NAVA backup.  
The minimum backup pressure level is 5 cmH<sub>2</sub>O.
- Tidal volume (ml) for VS backup.
- Respiratory rate (b/min)
- I:E or Ti (s) (depending on configuration)

Refer to section Important settings on page 108.

## Backup ventilation trends

The number of switches to backup ventilation per minute is trended under *TRENDS & LOGS/TRENDS*.

The percentage time spent in backup ventilation per minute is also trended.

## No consistent patient effort

This alarm occurs in invasive ventilation only.

If the patient fulfils the criteria for the *No consistent patient effort* alarm, the ventilator system will lock in backup ventilation.

A dialog *Backup ventilation active - review ventilation settings or continue in supported mode* is displayed on the screen. A choice must be made or this dialog will remain open and the ventilator system will remain in backup ventilation.

Tap *Review ventilation settings* in the dialog window to return to the mode settings window.

- Tap *Cancel* to close the mode settings window without changes being applied. Ventilation will continue as before, i.e. in backup ventilation.
- Tap *Accept* to accept the settings and continue in the supported mode with a reset apnea time.

Alternatively, tap *Continue in supported mode* in the dialog window to return to the supported mode. The apnea time will be reset.

In the neonatal patient category only, the *No consistent patient effort alarm* can be turned off in NAVA.

Refer to chapter Alarm handling on page 145 and to section Alarm limits on page 189.

## Apnea audio delay

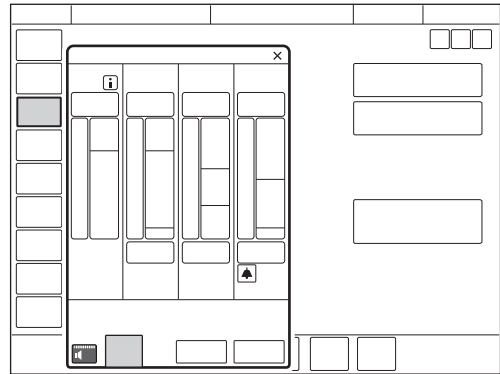

In the neonatal patient category only, the *No patient effort* alarm can be delayed. The setting is made by tapping *Apnea audio delay*, which is displayed, when relevant, at the bottom left of the *ALARM LIMITS* window.

In the event of apnea, the message *Alarm audio paused* is displayed in the status bar. Refer to section Alarm limits on page 189.

### 6.19.3 Deactivating backup ventilation

It is possible to deactivate backup ventilation for invasive PS/CPAP and VS. If backup ventilation is deactivated, the *No patient effort* alarm will be activated at the end of the apnea time but no backup ventilation will start.

This possibility is disabled by default. To allow deactivation of backup ventilation:

- Tap *SERVICE & SETTINGS* in the extended menu in *STANDBY*.
- Tap *BIOMED* and enter the code, then tap *CONFIGURATION/STARTUP CONFIGURATION/Deactivation of backup function*.
- Change from *Not allowed* to *Allowed*.

If this choice is made, *Deactivate backup ventilation* is displayed at the top right of the mode settings window during ventilation.

#### Notes:

- Backup ventilation can never be deactivated for the neonatal patient category.
- It is only possible to deactivate backup ventilation during ventilation.

To deactivate backup ventilation:

- Tap *Deactivate backup ventilation* in the mode settings window.
- A confirmation dialog *Do you really want to deactivate backup ventilation?* is displayed. Confirm by pressing *Yes*.
- Tap *Accept* in the mode settings window.
- *Backup ventilation off* is displayed after the mode name in the heading when ventilation then begins.

The backup function is automatically re-activated if:

- a change is made to a controlled mode of ventilation
- the ventilator system is switched to Standby
- the system is turned off.

**Note:** Backup ventilation remains inactive if a change of mode is made between PS/CPAP and VS.

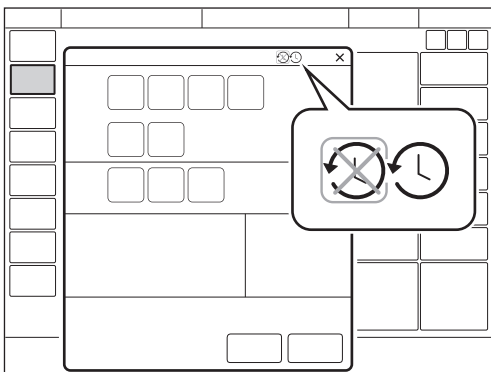

## 6.20 Nebulization

### 6.20.1 Aerogen nebulizers – general

The nebulizer is intended for administering drugs to patients requiring mechanical ventilation.

The nebulizer operates for a specific period of time or continuously regardless of ventilation mode setting. No extra gas volume is added, i.e. ventilator system settings and values are not affected.

Refer also to the manufacturer's operating manual for instructions for use.

### 6.20.2 Safety guidelines

#### **WARNINGS!**

- The nebulizer must not be left unattended when connected to a patient.
- Before administering any medication via the nebulizer, consult the manufacturer regarding the appropriateness of nebulization for that medication. Only use physician prescribed solutions.
- Do not use the nebulizer without a filter, e.g. Servo Duo Guard, connected to the expiratory inlet of the ventilator system. Refer to the Servo Duo Guard User's Manual.
- During nebulization, carefully monitor the airway pressure. Increased airway pressure could result from a clogged expiratory filter. Replace the filter if the expiratory resistance increases.
- The ventilator system accuracy can be affected by the gas added by use of other nebulizers than Aerogen nebulizer.

- During nebulization, check frequently that aerosol is being generated.
- Disconnect the SERVO Humidifier/HME during nebulization; otherwise the humidifier may become blocked or the drug may be trapped in the humidifier.
- To avoid explosion hazards, do not use flammable agents such as ether and cyclopropane or aerosolize alcohol-based medications which can ignite in oxygen enriched air under high pressure with this device.
- To avoid mechanical or electrical damage, do not drop the nebulizer unit.

#### **CAUTIONS:**

- Before starting the nebulizer, check that the medication cup is undamaged and firmly in place.
- If a nebulizer and CO<sub>2</sub> analyzer are in use simultaneously, the CO<sub>2</sub> reading may be affected.
- If the nebulizer is used with active humidification, then the particle size of the medication may be affected.
- Perform a function test prior to use to verify proper operation.

**Important:**

- When using a nebulizer, the accuracy of the Y sensor measurement may be compromised. Remove the Y sensor from the patient circuit when a nebulizer is in use.
- Condensate can collect and occlude ventilator system circuits. Always position ventilator system circuits so that fluid condensate drains away from the patient.
- Do not touch the domed aperture plate in the center of the nebulizer.
- Do not use the Aerogen Pro nebulizer unit in the continuous nebulization.
- Always maintain the nebulizer in a vertical position (with the filler cap uppermost) while in the patient circuit. This position prevents condensate from blocking the nebulizer and ensures proper nebulization.
- When removing the nebulizer unit from the patient circuit, always replace the T piece plug to maintain circuit pressure.
- The nebulizer unit and T piece, as packaged, are not sterile.
- Never use reusable connectors with disposable nebulizer units and vice versa.

Refer to section Nebulizer function test on page 132.

**6.20.3 Use guidelines****Assemble nebulizer unit**

**Important:** Use only with components specified by Maquet/Aerogen.

- Perform a function test prior to use to verify proper operation. Refer to section Nebulizer function test on page 132.
- Connect the nebulizer unit to the T piece by pushing the nebulizer unit firmly onto the T piece.

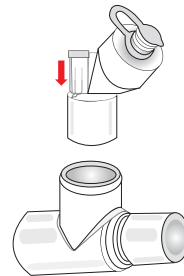

- Insert the nebulizer and the T piece into the inspiratory tube of patient circuit close to the Y piece.

- Connect the control cable to the ventilator system.

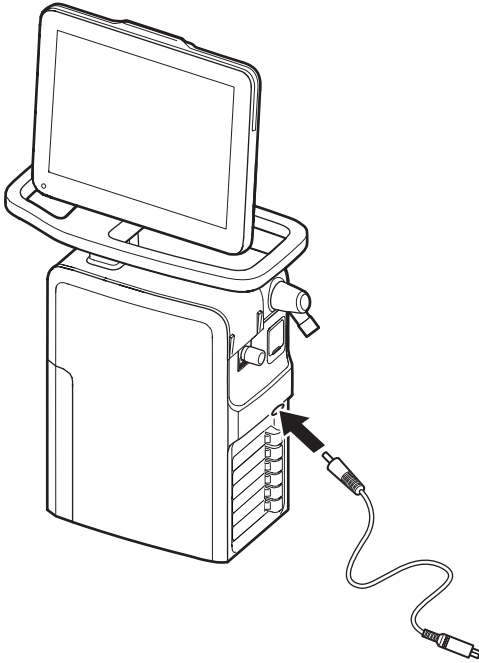

### Connection to patient circuits

Connect the nebulizer between the inspiratory tube and the Y piece. Connect the control cable to the ventilator system.

- **Connecting to 22 mm patient circuits**

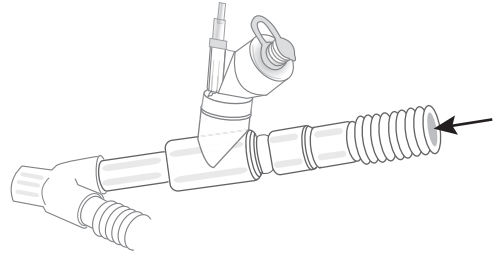

- **Connecting to 15 mm patient circuits**

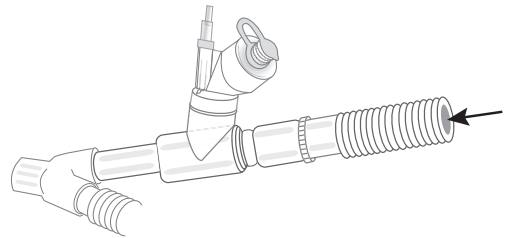

- **Connecting to 10 mm patient circuits**

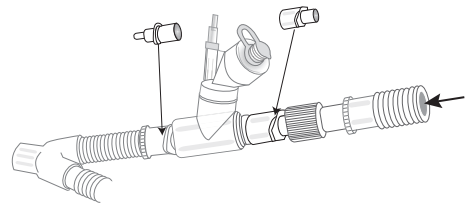

- **Connecting to 12 mm neonatal patient circuits using neonate T piece**

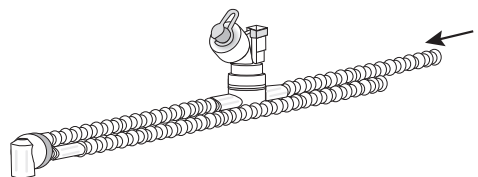

## Nebulizer function test

Perform a function test prior to first use or at any time to verify proper operation.

- Visually inspect each part of the system for cracks or damage and replace if any defects are visible.
- Pour 1-6 ml of sterile water or normal saline (0.9 %) into the nebulizer unit.
- Connect the control cable to the ventilator system.
- Start nebulization.
- Check that the aerosol is visible.
- Discard any remaining liquid before patient use.

## Adding medication

**Note:** Do not use a syringe with a needle to add medication.

- Open the filler cap plug on the nebulizer unit.
- Use a pre-filled ampoule or syringe to add medication into the filler port of the nebulizer unit.
- Close the filler cap plug.

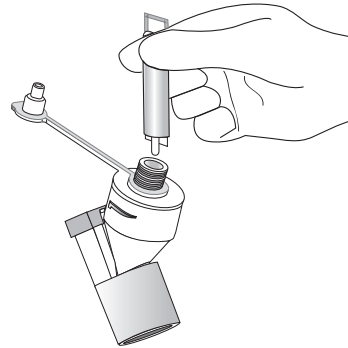

**Note:** Medication can also be added in this manner during nebulization. This does not interrupt nebulization or ventilation.



## Nebulization

Nebulization can be either:

- switched on/off for a certain period of time
- continuous, only Aerogen Solo

## Nebulization On/Off

To operate the nebulizer for a specific period of time (on/off):

1. Tap *MANEUVERS/NEBULIZATION*.
2. Tap *Time* if more or less than 10 minutes is required and adjust the figure up or down.

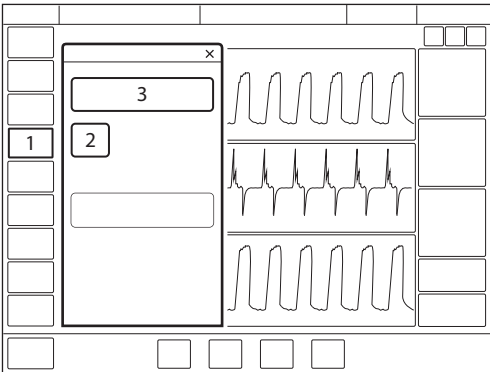

If the nebulizer cable is not connected, a dialog *Check nebulizer cable connection* is displayed on the screen. Tap *OK* to accept.

3. Tap *START NEBULIZATION PERIOD*. The default is 10 minutes.
4. Check that nebulization is in progress and how much time remains by looking at the progress symbol.

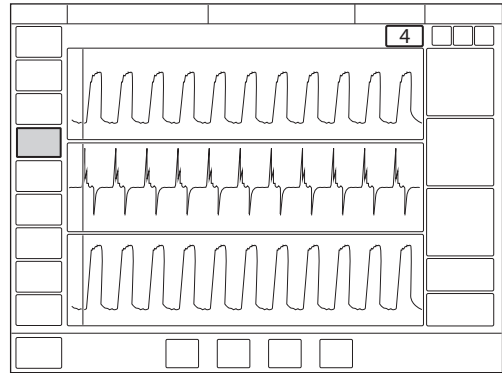

5. To stop nebulization tap *MANEUVERS/NEBULIZATION* or the nebulization shortcut in the status bar.
6. Tap *STOP NEBULIZATION PERIOD*.

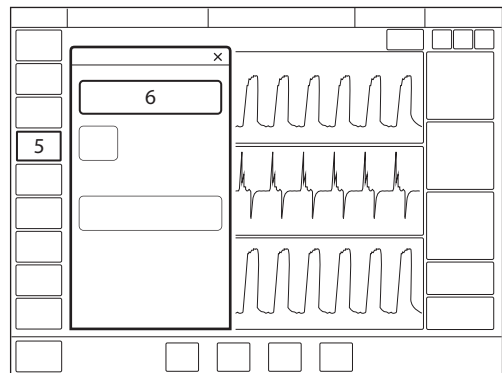

### 6.20.4 Pro nebulizer unit

When the nebulizer unit is connected into the inspiratory tube, the filler cap plug can be opened and closed in between doses without causing loss of circuit pressure.

**WARNING!** Do not attach a continuous supply of medication to the nebulizer; the device operates in 5 to 30 minute cycles.

### 6.20.5 Solo nebulizer unit

When the nebulizer unit is connected into the inspiratory tube, the filler cap plug can be opened and closed in between doses without causing loss of circuit pressure.

**WARNING!** Do not use the Solo nebulizer in conjunction with the administration of volatile anaesthetics as this may have an adverse effect on the Solo nebulizer or T piece plastics.

**Important:** This is a single patient use device not to be used on more than one patient to prevent cross-infection.

### Continuous nebulization

See Aerogen Continuous Nebulization Tube assembly instructions.

#### CAUTIONS:

- Check regularly the level of medication in the nebulizer unit during continuous nebulization.
- There is no alarm to indicate that the nebulizer is empty.

**Important:** To ensure correct and safe connection between the nebulizer and the medication reservoir, follow the medication tube from the nebulizer to the medication reservoir to make sure that the medication tube is connected to the correct source.

The input rate of medication into the nebulizer unit during continuous nebulization must not exceed 0.2 ml per minute or 12 ml per hour. Dose volumes and concentrations must be determined accordingly.

To operate the nebulizer in continuous mode:

1. Tap *MANEUVERS/NEBULIZATION*.
2. Tap *START CONTINUOUS NEBULIZATION*.

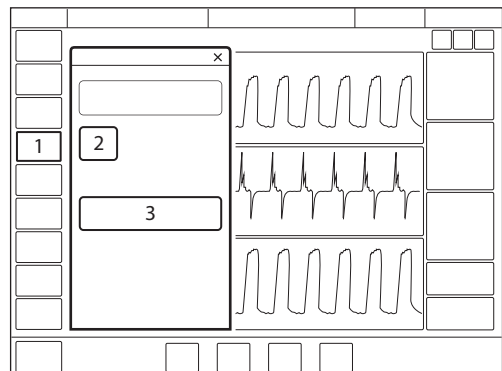

A dialog *Ensure that an Aerogen Solo nebulizer unit is connected* is displayed on the screen. Tap *Accept*.

3. Check that nebulization is in progress by looking at the progress symbol.

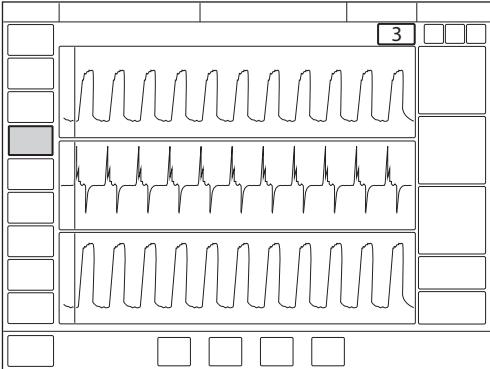

4. To stop nebulization tap *MANEUVERS/NEBULIZATION* or the nebulization shortcut in the status bar.
5. Tap *STOP CONTINUOUS NEBULIZATION*.

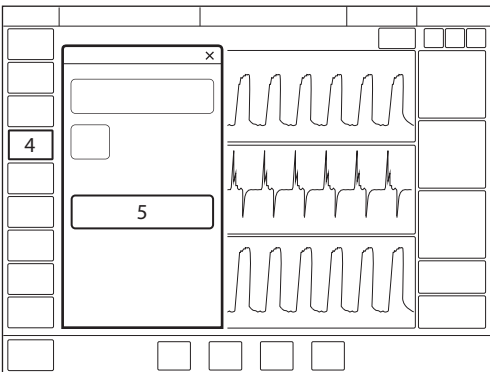

## 6.21 CO<sub>2</sub> monitoring

### 6.21.1 CO<sub>2</sub> analyzer

When the CO<sub>2</sub> analyzer is in use, the following data is displayed on the screen:

- CO<sub>2</sub> concentration (waveform)
- etCO<sub>2</sub> concentration
- CO<sub>2</sub> minute elimination
- CO<sub>2</sub> tidal elimination

**CAUTION:** If a nebulizer and CO<sub>2</sub> analyzer are in use simultaneously, the CO<sub>2</sub> reading may be affected.

Alarm limits for high and low etCO<sub>2</sub> can be individually set.

**Important:** If the upper alarm limit is set above the maximum measuring range, no alarm will be activated even if the upper limit is exceeded.

### 6.21.2 Use guidelines

The sensor and airway adapter windows should be placed vertically to reduce the possibility of optical interference due to window contamination. Connect the airway adapter between the Y piece/SERVO Humidifier and the endotracheal tube/face mask/prongs.

Do not insert two CO<sub>2</sub> modules at the same time. The ventilator system can only handle one CO<sub>2</sub> module at a time.

Check the CO<sub>2</sub> analyzer when replaced.

Use only a Maquet airway adapter together with the sensor.

If the message *Check CO<sub>2</sub> airway adapter* appears, then make sure that the adapter is completely inserted.

Wipe the airway adapter if necessary.

Refer to the Cleaning and Maintenance User's manual.

### 6.21.3 CO<sub>2</sub> analyzer components

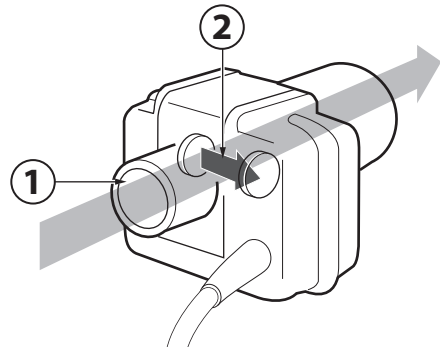

1. Gas flow through the airway adapter in the sensor.
2. The sensor uses a solid state and IR based optical system with no moveable parts. It measures the difference between a reference light beam and one filtered for CO<sub>2</sub> wavelengths.

The airway adapter can be either disposable or reusable.

**CAUTION:** The disposable airway adapter is intended for single patient use only, do not re-use, clean or sterilize.

### 6.21.4 CO<sub>2</sub> analyzer calibration

Before beginning the calibration procedure the sensor needs to be warm, this is done automatically. Values displayed during warm-up have reduced accuracy. If calibration is needed, a message will appear.

#### CAPNOSTAT 5

To calibrate the CO<sub>2</sub> analyzer:

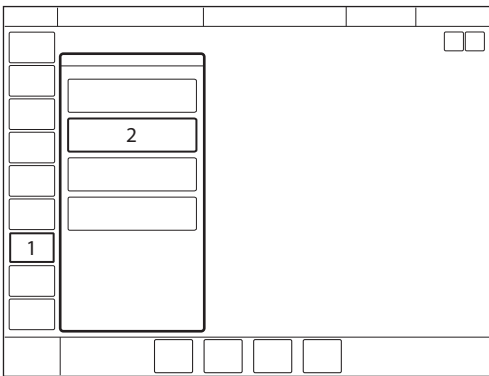

1. Tap *CALIBRATION & TESTS* in the quick menu if in Standby or extended menu if in running.
2. Tap *CO<sub>2</sub> SENSOR CALIBRATION*.

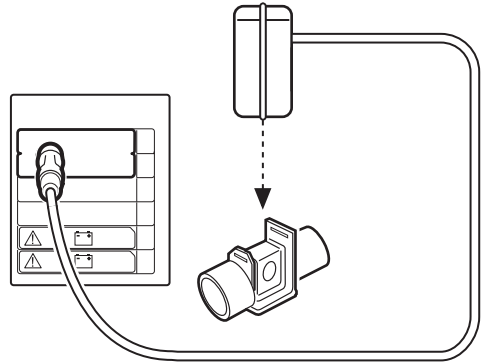
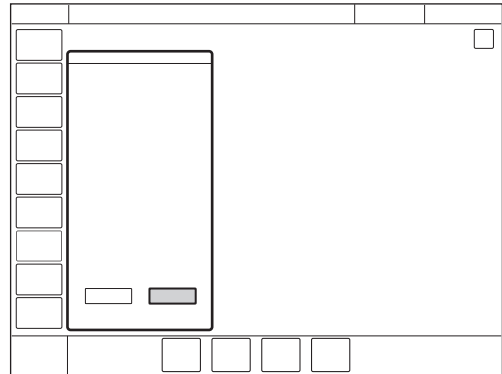

Place the sensor on an unconnected airway adapter, containing room air. Tap *OK*.

### CAPNOSTAT 3

There are two calibration choices:

- full calibration
- zero offset adjustment

To calibrate the CO<sub>2</sub> analyzer:

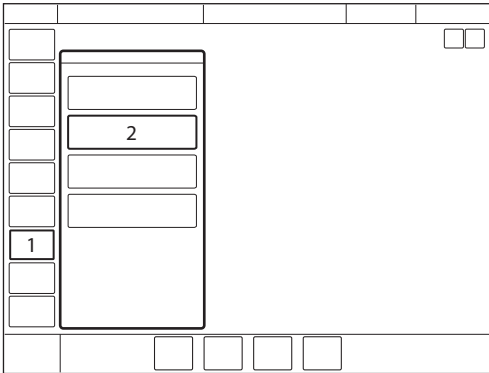

1. Tap *CALIBRATION & TESTS* in the quick menu if in Standby or extended menu if in running.
2. Tap *CO<sub>2</sub> SENSOR CALIBRATION*.

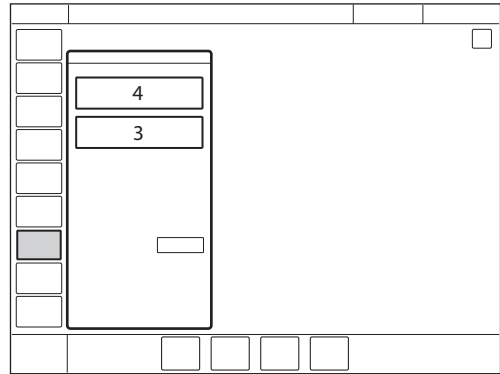

3. If the CO<sub>2</sub> module has been fully calibrated, there is an option to do zero offset adjustment. Tap *Zero offset adjustment* if the sensor has been shifted.
4. Tap *Full calibration* to perform a calibration including zero offset adjustment, reference adjustment and airway adapter check.

**Important:** Full calibration is recommended. Always perform a full calibration when the airway adapter is altered, a faulty sensor is suspected, or the system requests calibration. Perform a zero offset adjustment if the sensor has been shifted.

- The *etCO<sub>2</sub> concentration low* alarm can be permanently silenced (Audio off) when the message *Silence alarm permanently?* is displayed.  
Refer to section Permanently silencing alarms on page 150.
- During calibration no CO<sub>2</sub> waveforms or measured CO<sub>2</sub> values will be displayed.

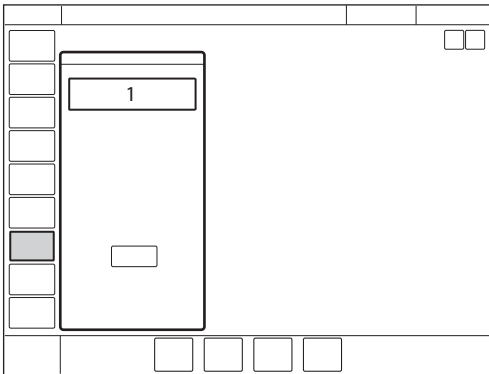
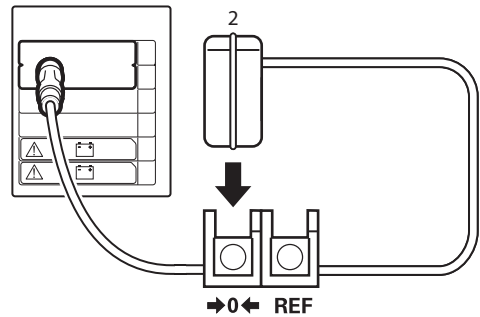
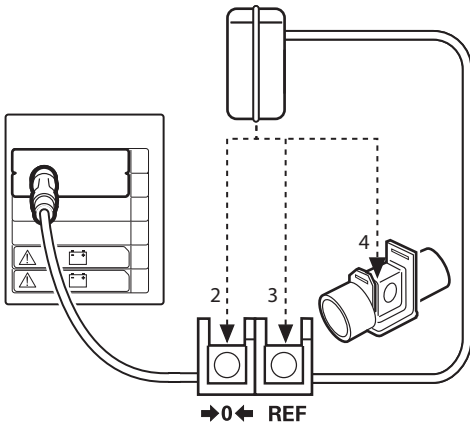
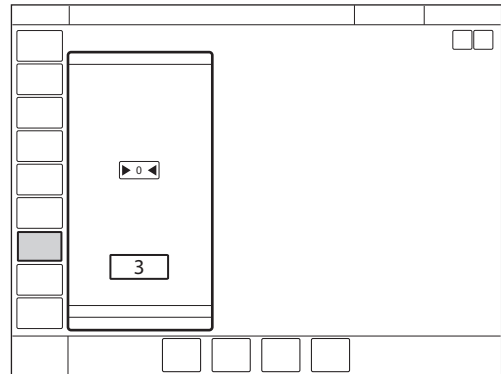
**full calibration****zero offset adjustment**

1. Tap *FULL CALIBRATION*; wait for on-screen instructions.
2. Place the sensor on the zero marking; wait for on-screen instructions.
3. Place the sensor on the REF marking; wait for on-screen instructions.
4. Place the sensor on an unconnected airway adapter, containing room air. Tap *OK*.

1. Tap *ZERO OFFSET ADJUSTMENT*; wait for on-screen instructions.
2. Place the sensor on the zero marking.
3. Tap *OK*.

## 6.22 Using a Y sensor

For tidal volumes below 10 ml, it is recommended to use a Y sensor to increase the accuracy of gas delivery and monitoring. For large flows, the Y sensor will add a considerable resistance. Refer to section Y sensor on page 203.

When the Y sensor is active, the flow through the sensor will replace the bias flow as source for flow based triggering. The patient pressure is measured at the Y piece via a pressure line.

The Y sensor can be used in all ventilation modes but cannot be used in the adult patient category.

The Y sensor is a hot wire anemometer type sensor.

The Y sensor is available in two different colors. Blue indicates disposable, single-use and yellow reusable.

- When using a nebulizer, the accuracy of the Y sensor measurement may be compromised. Remove the Y sensor from the patient circuit when a nebulizer is in use.
- To interrupt the Y sensor measuring, disconnect the Y sensor module.
- To maintain accuracy in volume measurements for small tidal volumes, the Y sensor should be kept at a warmer temperature, above normal room temperature, to minimize the condensation in the Y sensor. If condensation occurs, the moisture should be removed from the Y sensor.

### **Notes:**

- To guarantee that waveforms and measured values are always displayed on the screen, the internal pressure and flow sensors are at all times active as backup. Their readings are compared with the Y sensor measurement. The Y sensor is disabled if there is a significant deviation or malfunction.
- A pre-use check or a patient circuit test and Y sensor calibration is required prior to using the Y sensor.
- Do not insert two Y sensor modules at the same time. The ventilator system can only handle one Y sensor module at a time.



### 6.22.1 Use guidelines

**CAUTION:** Frequently check for condensed water or other fluids in the Y sensor. Fluids in the Y sensor can cause immediate loss of accuracy or long-term drift.

- Connect the pressure line to the Y piece and module.
- Connect the cable to the Y sensor and module.
- Calibrate the Y sensor.
- Connect the Y sensor between the Y piece and the endotracheal tube.
- Do not apply tension to the Y sensor pressure line.
- Make sure that the connectors to the ventilator system are pointing upwards.
- Make sure there are no kinks in the Y sensor pressure line.
- If the Y sensor is not connected to the module, do not connect to the patient circuit as this may cause leakage.
- The Y sensor shortcut opens the dialog *Y SENSOR STATUS*.

Do not insert two Y sensor modules at the same time. The ventilator system can only handle one Y sensor module at a time.

### 6.22.2 Y sensor components

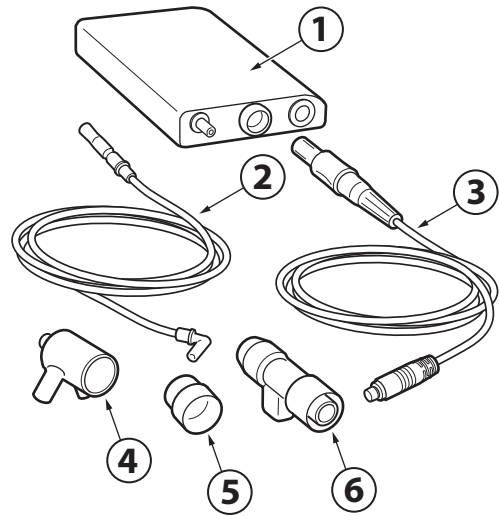

1. Y sensor module
2. Pressure line
3. Y sensor cable
4. Y piece including pressure line connection port
5. CO<sub>2</sub>/Y sensor adapter, to use with the neonatal CO<sub>2</sub> airway adapter.
6. Y sensor

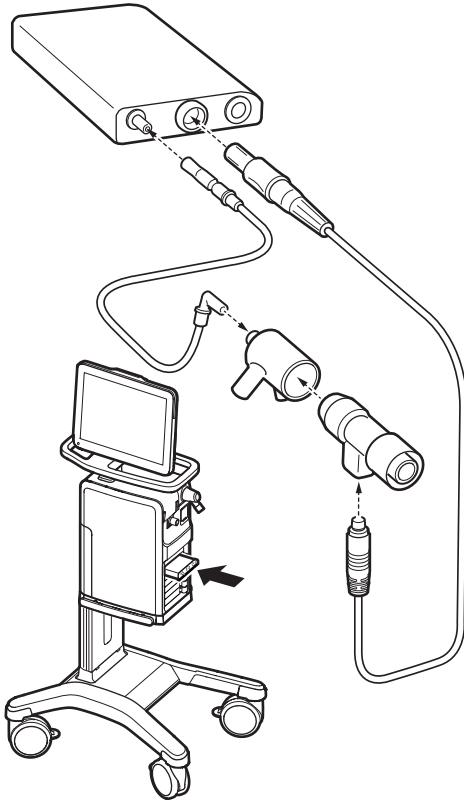

### 6.22.3 Y sensor calibration

Before starting, insert the Y sensor module into the ventilator system and connect the Y sensor to the Y sensor module.

The Y sensor must be calibrated to function.

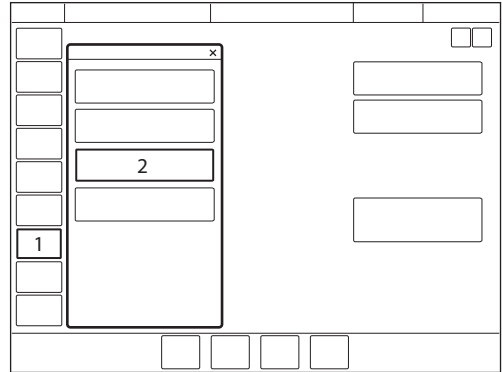

1. Tap *CALIBRATION & TESTS* in the quick menu if in Standby or extended menu if in running.
2. Tap *Y SENSOR CALIBRATION*.
3. A dialog in several steps is displayed. Follow on-screen instructions.

## 6.23 Adjust the O<sub>2</sub> cell

**Note:** This does not apply if the ventilator system has an O<sub>2</sub> sensor fitted.

If the ventilator system has been in continuous use for an extended period, the measured O<sub>2</sub> concentration may drop due to normal degradation of the oxygen cell. In order to avoid nuisance alarms in this situation, it is possible to temporarily adjust the O<sub>2</sub> cell during ventilation.

When performing a O<sub>2</sub> cell adjustment, the O<sub>2</sub> cell is adjusted so that the current measured O<sub>2</sub> concentration is equal to the set O<sub>2</sub> concentration. This temporary adjustment will be valid until the ventilator system is switched off.

**Important:** Before using the ventilator system, always perform a pre-use check to make sure the O<sub>2</sub> cell is properly calibrated.

To adjust the O<sub>2</sub> cell:

- Tap *CALIBRATION & TESTS* in the extended menu.
- Tap *O<sub>2</sub> CELL ADJUSTMENT* once, then again.
- Tap Yes to perform the O<sub>2</sub> cell adjustment.
- Tap *OK*.



## 7 Alarm handling

### Table of contents

|     |                              |     |
|-----|------------------------------|-----|
| 7.1 | Introduction                 | 146 |
| 7.2 | Handling alarms              | 147 |
| 7.3 | Permanently silencing alarms | 150 |
| 7.4 | Turning off alarms           | 151 |
| 7.5 | System messages              | 153 |
| 7.6 | Alarm output connection      | 162 |

## 7.1 Introduction

### 7.1.1 General

The ventilator system is equipped with an alarm system to help ensure patient safety. Visual and audible alarms warn about:

- patient breathing problems e.g. apnea
- power problems e.g. loss of mains power
- problems with gases e.g. low supply pressure
- technical problems e.g. memory failure

**WARNING!** A potential hazard can arise if different default alarm settings are used on ventilator systems or similar equipment which are located within the same intensive care unit.

**Important:** Those responding to alarms must be healthcare professionals who have experience in ventilation treatment and who have been trained in the use of this ventilator system.

**Note:** The alarm log is not affected by system shutdown or a temporary loss of power (supply mains and/or battery power).

Refer to section Set alarm limits on page 43.

### 7.1.2 Conditions leading to default alarm settings

Alarm limits are set to their default values when:

- powering on the ventilator system
- changing ventilation type (invasive/non invasive)
- changing patient category in *STANDBY*

## 7.2 Handling alarms

### 7.2.1 Alarm indication

The alarms are divided into three priorities:

- high priority — all alarm indications turn red
- medium priority — all alarm indications turn yellow
- low priority — all alarm indications turn blue

Technical error messages indicating a technical problem are presented together with a numeric code, TE: x.

When the alarm log is full, the oldest data is discarded when new alarms are added.

An alarm message explaining the cause of the alarm is displayed in the alarm list in the status bar.

The corresponding numerical value flashes with the color of the alarm priority and the exceeded set limit is circled in the same color.

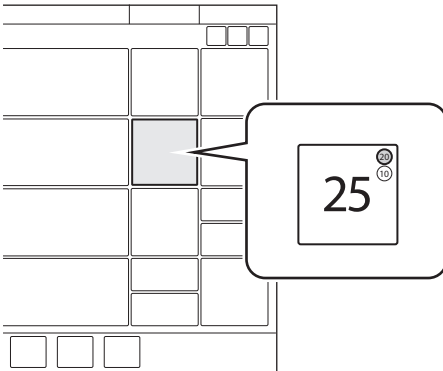

To open the specific alarm scale, tap the flashing numerical value.

Refer to section Set alarm limits on page 43.

### Alarm sound level

When one or more alarms are activated, the system will present the audio signal corresponding to the alarm with the highest priority that is not silenced or turned off.

The alarm volume can be set in the *ALARM LIMITS* window.

Refer to section Set alarm sound level on page 44.

The default alarm sound level can be set in *SERVICE & SETTINGS/BIOMED/CONFIGURATION/ALARMS* window.

Refer to section Alarms on page 168.

### 7.2.2 Viewing active alarms

If more than one alarm is active, open the alarm list in the status bar.

All alarms by priority are displayed in the alarm list. The list will be continuously updated when additional alarms occur.

Each alarm is displayed together with a list of recommended actions.

Tap *Alarm history* in the alarm list to open the *ALARM HISTORY* window.

### 7.2.3 Responding to alarms

Active alarms can be silenced for two minutes by tapping *Audio pause* in the status bar.

*Audio paused* along with the time remaining in the silent period are displayed.

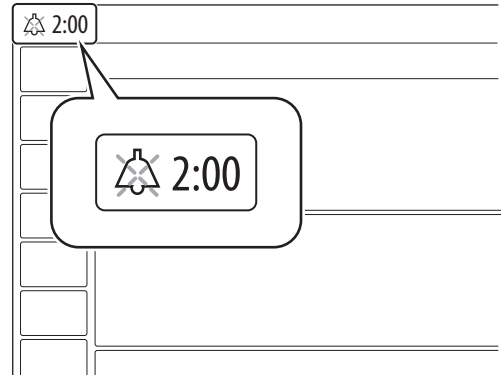

*Audio pause* must be tapped for each alarm that is activated.

If *Audio Paused* is tapped before the silent period has expired, then the alarm signal will be turned on again.

**Note:** The *No battery capacity* alarm and high priority technical alarms cannot be silenced.

To respond to alarms:

- Tap *Audio pause* to silence the alarm for two minutes.
- Take action to resolve the alarm condition.

Low and medium priority alarms are automatically reset once the alarm condition ceases.

Refer to section *Resetting Check alarms* on page 149.



## 7.2.4 Pre-silencing alarms

To silence most alarms for two minutes, tap *Audio pause* when no alarms are active. A crossed double bell, *Audio pause - all alarms*, along with the time remaining in the silent period are displayed.

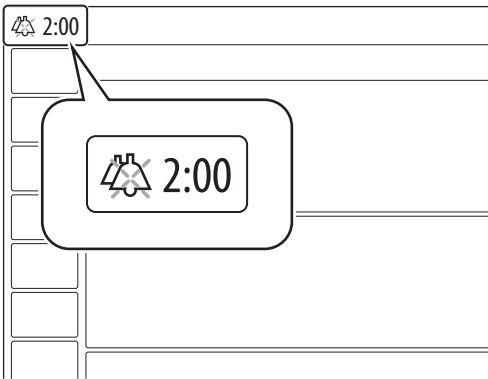

## 7.2.5 Responding to technical alarms

In some cases, restarting the system may resolve a technical alarm. However, technical alarms often necessitate taking the ventilator system out of operation and having it serviced.

Refer to section Technical error messages on page 161.

## 7.2.6 Resetting Check alarms

*Check alarms* is an indication of high priority alarms that have ceased. The alarm indication remains visible in the status bar and in the alarm list until the *ALARM HISTORY* window is opened.

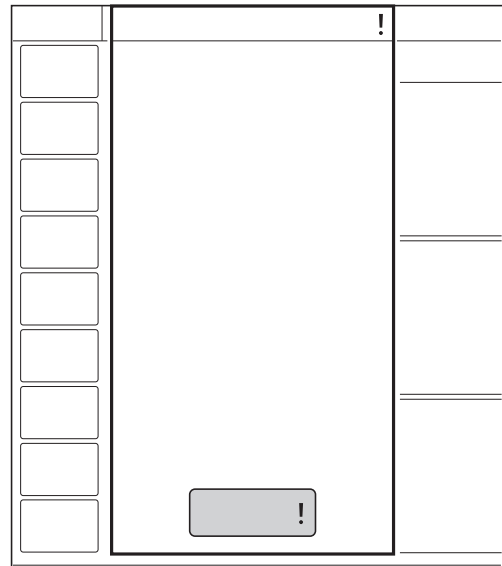

To reset *Check alarms*:

Tap *Alarm history !* in the alarm list.

The *ALARM HISTORY* window opens and the *Check alarms* is reset. The indication is cleared from the screen.

### 7.3 Permanently silencing alarms

Certain alarms can be permanently silenced in the *ALARM LIMITS* window.

#### In non invasive ventilation:

- expiratory minute volume
- respiratory rate
- end expiratory pressure
- end tidal CO<sub>2</sub> (CO<sub>2</sub> analyzer)
- CPAP (Nasal CPAP)

#### In invasive ventilation:

- expiratory minute volume (lower alarm limit)

This is only available in the neonatal patient category.

**WARNING!** Always ensure adequate external patient monitoring (e.g. SpO<sub>2</sub>, CO<sub>2</sub>) in invasive ventilation when the *Expiratory minute volume low* alarm is set to *Audio off*.

To permanently silence alarms:

- Tap *ALARM LIMITS* in the extended menu.
- Tap *Audio pause* below the alarm limit setting and select *Audio off*.
- Tap *Accept*.

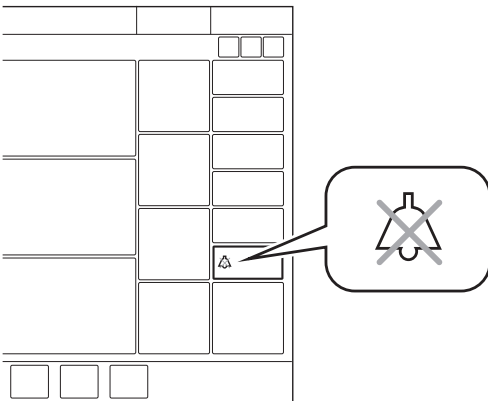

*Audio off* is displayed in the corresponding parameter in the numerical values area and a message is displayed in the status bar.

**Note:** The default alarm settings are automatically set when switching between invasive and non invasive modes.

The alarms can be set to permanently silenced as default in *SERVICE & SETTINGS/BIOMED/CONFIGURATION/ALARMS* window.

Refer to section Alarms on page 168.

## 7.4 Turning off alarms

### 7.4.1 Turning off leakage and volume alarms

Following alarms can be turned off in invasive ventilation when leakage compensation is turned on:

- Leakage too high
- Expiratory minute volume low
- Expiratory minute volume high
- Inspiratory tidal volume too high

This is only available in the neonatal patient category and in following ventilation modes:

- PC
- PS
- NAVA
- Automode
- SIMV (PC) + PS

**WARNING!** Always ensure adequate external patient monitoring (e.g. SpO<sub>2</sub>, CO<sub>2</sub>) when the Expiratory minute volume low alarm is turned off.

To turn off the leakage and volume alarms:

- Tap *ALARM LIMITS* to open the *ALARM LIMITS* window.
- Tap *Alarm on* and select *Alarm off*.

When the *Leakage alarms* is set to off, all three alarms will be turned off.

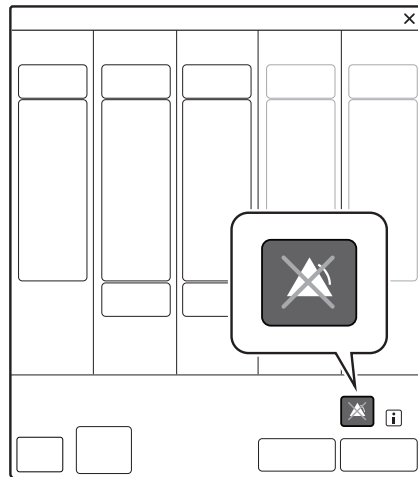

*Alarm off* is displayed in the corresponding parameter in the numerical values area and a message is displayed in the status bar.

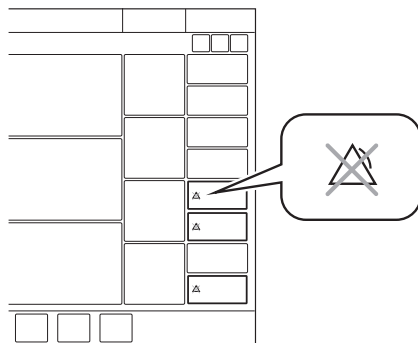

The ventilator will automatically turn on the alarms when it is switched to Standby; the patient category is changed or when set to a ventilation mode where these alarms cannot be turned off.

### 7.4.2 Turning off the *Leakage too high* alarm

The *Leakage too high* alarm that occurs when leakage in NIV NAVA exceeds 95 % can be turned off.

This is only available in pediatric and neonatal patient categories.

To turn off the alarm for leakage, the ventilator system has to be configured as follows:

- Tap *SERVICE & SETTINGS/BIOMED/CONFIGURATION/ALARMS* to configure the ventilator system.  
Refer to section Alarms on page 168.
- Select the tab for the appropriate patient category.
- Tap on *Not allowed* and choose *Allowed*.
- Tap *Save all*.
- Tap *EXIT* to close the window.

When *Disabling of Leakage too high alarm* is set to *Allowed* in the configuration, *Alarm on* is displayed in *ALARM LIMITS* window.

Turn off the alarm by tapping the *Alarm on* and select *Alarm off* in the *ALARM LIMITS* window.

### 7.4.3 Turning off NAVA apnea alarms

The apnea alarm *No patient effort* can be turned off in NAVA and NIV NAVA.

If the *No patient effort* alarm is turned off in NAVA, this will automatically turn off the *No consistent patient effort* alarm as well.

This is only available in the neonatal patient category.

If the *No patient effort* alarm is turned off, the ventilator system will switch to backup ventilation when the time between breaths exceeds the apnea time setting. The switch to backup ventilation is always active irrespective of any changes in the *ALARM LIMITS* window.

To turn off the apnea alarm:

- Tap *ALARM LIMITS* to open the *ALARM LIMITS* window.
- Tap *Alarm on* and select *Alarm off*.

When the *No patient effort* alarm is set to off, all apnea related alarms will be turned off. Backup ventilation will remain active but the ventilator system will never lock in backup.

Once set, the NAVA apnea alarm configuration remains valid until the system has been turned off. Restarting the system restores default alarm configuration.

## 7.5 System messages

### 7.5.1 Introduction

**WARNING!** Always disconnect the patient from the ventilator system when performing operations that involve risk for the patient, such as replacing the O<sub>2</sub> cell, dismantling etc.

**Notes:**

- Do not lift or disconnect the expiratory cassette when the ventilator system is operating, instead this may be done in Standby.
- Most technical problems require the attention of service personnel.

## 7.5.2 High priority alarms

| Alarm message                    | Possible causes   | Alarm management checklist   |
|----------------------------------|---|--|
| Airway pressure high             | <p>Airway pressure exceeds preset upper pressure limit.</p> <p>Kinked or blocked tubing.</p> <p>Mucus or secretion plug in endotracheal tube or in airways.</p> <p>Patient coughing or fighting ventilator.</p> <p>Inspiratory flow rate too high.</p> <p>Improper alarm setting.</p> <p>Blocked expiratory filter.</p> | <p>Check patient circuit.</p> <p>Check expiratory filter.</p> <p>Check ventilator settings.</p> <p>Check alarm limits.</p> |
| Apnea                            | <p>Preset or default alarm limit exceeded.</p> <p>Time between two consecutive inspiratory efforts exceeds the set alarm limit.</p>   | <p>Check patient.</p> <p>Check ventilator settings.</p>  |
| Patient circuit disconnected     | <p>Problems with patient circuit or expiratory pressure transducer.</p> <p>Disconnected pressure transducer (expiratory or inspiratory).</p> <p>Blocked pressure transducer (expiratory or inspiratory).</p> <p>Excessive leakage.</p>  | <p>Check patient circuit.</p>  |
| Time in waiting position > 2 min | <p>Time in waiting position is exceeded.</p> <p>Patient is not connected to the ventilator or leakage is excessive.</p>   | <p>Connect patient.</p> <p>Check patient circuit.</p>  |
| Leakage too high                 | <p>Leakage too high. The mask/prongs may not be adjusted properly for the patient or may be the wrong size.</p>   | <p>Check patient interface.</p> <p>Check patient circuit.</p>  |
| Gas supply pressures low         | <p>Air and O<sub>2</sub> supply is below 2.0 kPa x 100 (29 psi).</p> <p>Air and O<sub>2</sub> gas supply disconnected.</p>  | <p>Check gas supply.</p>   |
| Expiratory minute volume low     | <p>Preset or default alarm limit exceeded.</p> <p>Low spontaneous patient breathing activity.</p> <p>Leakage around the cuff.</p> <p>Leakage in the patient circuit.</p> <p>Improper alarm setting.</p> <p><b>Note:</b> This alarm also works as a patient disconnect alarm.</p>  | <p>Check patient.</p> <p>Check patient circuit.</p> <p>Check ventilator settings.</p> <p>Check support level.</p>          |
| Battery voltage low              | <p>Battery voltage too low. Cannot guarantee continued ventilator system operation.</p>   | <p>Connect to mains power.</p> <p>Replace all batteries.</p>   |
| No battery capacity              | <p>Less than 3 minutes left of battery operation.</p>   | <p>Connect to mains power.</p> <p>Insert charged batteries.</p>  |

| Alarm message  | Possible causes   | Alarm management checklist   |
|--|---|--|
| Airway pressure continuously high                                  | Obstruction leading to constant high airway pressure (>PEEP +15 cmH <sub>2</sub> O) during: <ul style="list-style-type: none"> <li>&gt; 2 breaths or 5 seconds, whichever is greater,</li> <li>15 ±1.5 s if less than 2 breaths are triggered)</li> </ul>   | Check patient circuit.<br>Check ventilator settings.<br>Check alarm limits.<br>Contact service technician.                           |
| O <sub>2</sub> concentration low                                   | Measured O <sub>2</sub> concentration is below the set value by more than 5 vol.% or concentration is below 18 vol.% which is independent of settings.<br>Gas delivered in O <sub>2</sub> supply line is not O <sub>2</sub> .<br>O <sub>2</sub> sensor faulty or exhausted.<br>O <sub>2</sub> cell uncalibrated.<br>Gas module for O <sub>2</sub> faulty. | Check O <sub>2</sub> supply.<br>If using an O <sub>2</sub> cell, perform O <sub>2</sub> cell adjustment.<br>Perform a pre-use check. |
| Patient disconnected > 1 min                                       | Patient circuit disconnected.   | Reconnect patient.<br>Check patient circuit.   |
| Alarm limits invalid   | Alarm limits lost.  | Replace the ventilator immediately.  |
| Inspiratory tidal volume too high (neonatal patient category only) | Assist level causing larger tidal volume than set alarm limit.<br>In PRVC and VS, a tidal volume setting that is significantly lower than patient demand.   | Check ventilator settings.<br>Check alarm limits.<br>Check patient circuit.  |
| Internal power failure - TE: 43                                    | Internal power failure.   | Replace the ventilator immediately.  |
| Power HW error - TE: 60  | Internal power failure.   | Replace the ventilator immediately.  |
| High inspiratory pressure  | Kinked or blocked tubing.<br>Blockage in patient interface.<br>High-flow nasal cannula is displaced.<br>Size of high-flow nasal cannula is too small for the set flow.  | Check patient.<br>Check patient interface.<br>Check patient circuit.<br>Check size of high-flow nasal cannula.                       |

### 7.5.3 Medium priority alarms

| Alarm message                      | Possible causes  | Alarm management checklist  |
|------------------------------------|--|---|
| Expiratory cassette disconnected   | The expiratory cassette is disconnected or not connected properly.   | Check that the expiratory cassette is properly inserted.                      |
| Limited battery capacity           | Less than 10 minutes left of battery operating time.   | Connect to mains power.<br>Replace all batteries.                             |
| Air supply pressure low            | Air supply pressure below 2.0 kPa x 100 (29 psi).<br>Air supply pressure at gas inlet is too low.<br>Gas supply line disconnected.<br><b>Note:</b> This alarm can be permanently silenced ( <i>Audio off</i> ) when activated.   | Check air supply.   |
| O <sub>2</sub> supply pressure low | O <sub>2</sub> supply pressure below 2.0 kPa x 100 (29 psi).<br>O <sub>2</sub> supply pressure at gas inlet is too low.<br>Gas supply line disconnected.<br><b>Note:</b> This alarm can be permanently silenced ( <i>Audio off</i> ) when activated.                         | Check O <sub>2</sub> supply.  |
| PEEP high                          | The measured end expiratory pressure is above the preset or default alarm limit for three consecutive breaths.   | Check patient circuit.<br>Check alarm settings.<br>Check ventilator settings. |
| PEEP low                           | The measured end expiratory pressure is below the preset or default alarm limit for three consecutive breaths.<br>Setting the alarm to zero turns the alarm off.<br>Leakage in patient circuit.<br>Leakage at patient connection (cuff, tracheal tube).                      | Check patient circuit.<br>Check alarm settings.<br>Check ventilator settings. |
| CPAP high                          | Preset or default alarm exceeded.  | Check patient circuit.<br>Check alarm settings.<br>Check ventilator settings. |
| CPAP low                           | Preset or default alarm exceeded.  | Check patient circuit.<br>Check alarm settings.<br>Check ventilator settings. |
| O <sub>2</sub> concentration high  | Measured O <sub>2</sub> concentration exceeds the set value by more than 5 vol.%.<br>Gas supply or air line disconnected.<br>No supply from wall outlet.<br>The air gas module is disconnected.<br>If no gas is available, then both expiratory and safety valves will open. | Check air supply.<br>Perform a pre-use check.                                 |



| Alarm message                       | Possible causes  | Alarm management checklist   |
|-------------------------------------|--|--|
| O <sub>2</sub> supply pressure high | O <sub>2</sub> supply pressure above 6.0 kPa x 100 (87 psi).<br>O <sub>2</sub> supply pressure at gas inlet is too high.                             | Check O <sub>2</sub> supply.   |
| O <sub>2</sub> cell/sensor failure  | O <sub>2</sub> cell/sensor missing or disconnected.  | Replace the ventilator as soon as it is safe for the patient.  |
| Pressure delivery is restricted     | The inspiratory flow has reached its upper limit, which restricts pressure delivery.   | The inspiratory flow has reached its upper limit, which restricts pressure delivery.<br>Check for leakage.<br>Check ventilator settings.   |
| etCO <sub>2</sub> low               | Hyperventilation.<br>Leakage with high bias flow.  | Check patient.<br>Check ventilator settings.<br>Check patient circuit.<br>Check CO <sub>2</sub> sensor.  |
| etCO <sub>2</sub> high              | Hypoventilation.<br>Leakage with high bias flow.   | Check patient.<br>Check ventilator settings.<br>Check patient circuit.<br>Check CO <sub>2</sub> sensor.  |
| Air supply pressure high            | Air supply pressure above 6.0 kPa x 100 (87 psi).<br>Air supply pressure at gas inlet is too high.   | Check air supply.  |
| Respiratory rate high               | Respiratory rate too high.<br>Autotriggering.  | Check patient.<br>Check ventilator settings.<br>Check patient circuit.   |
| Respiratory rate low                | Respiratory rate too low.<br>Trigger setting incorrect.<br>Large tidal volume.   | Check patient.<br>Check ventilator settings.<br>Check patient circuit.   |
| Expiratory minute volume high       | Preset or default alarm limit exceeded.<br>Increased patient activity.<br>Ventilator self-triggering (autocycling).<br>Improper alarm limit setting. | Check patient.<br>Check ventilator settings.<br>Check patient circuit.   |
| Leakage too high                    | Leakage too high. The mask/prongs may not be adjusted properly for the patient or may be the wrong size.   | <b>In invasive ventilation:</b><br>Check patient circuit.<br>Check endotracheal tube.<br><b>In non invasive ventilation:</b><br>Check patient circuit.<br>Check patient interface. |
| Expiratory cassette error           | Technical problem with the expiratory cassette.  | Replace the expiratory cassette.<br>Perform a pre-use check.<br>Contact service technician.  |

| Alarm message                               | Possible causes  | Alarm management checklist  |
|---|--|---|
| Edi signal invalid                          | Backup ventilation is active due to invalid Edi signal.  | Check catheter position.  |
| Edi signal interference from ECG            | Backup ventilation is active due to interference from the ECG signal.  | Backup ventilation is active due to interference from the ECG signal.<br>Check Edi catheter position. |
| The nebulizer cannot be run on one battery  | Only one battery module is connected.  | Insert charged batteries.   |
| Nebulizer hardware error                    | Technical problem with nebulizer hardware.<br>Technical problem with connection cable.   | Contact service technician.   |
| Nebulizer disconnected                      | The nebulizer is disconnected during nebulization.<br>Technical problem with connection cable.   | Check nebulizer connection.   |
| No patient effort                           | An apnea has caused the ventilator to switch to backup ventilation.  | Check patient.<br>Check ventilator settings.  |
| No consistent patient effort                | The ventilator has switched between supported and backup ventilation four times in two minutes.<br><br>The patient has only triggered a single breath to interrupt each of two consecutive backup periods. | —   |
| CO <sub>2</sub> module disconnected         | CO <sub>2</sub> module is not properly inserted.   | —   |
| CO <sub>2</sub> module conflict             | Two CO <sub>2</sub> modules are connected at the same time.  | Remove one CO <sub>2</sub> module.  |
| CO <sub>2</sub> module error                | Hardware error in the CO <sub>2</sub> module.  | Replace CO <sub>2</sub> module.   |
| CO <sub>2</sub> sensor error                | Hardware error in CO <sub>2</sub> sensor.  | Replace CO <sub>2</sub> sensor.   |
| CO <sub>2</sub> sensor temperature too high | Possible hardware error.   | Replace CO <sub>2</sub> sensor.   |
| CO <sub>2</sub> sensor temperature too low  | The CO <sub>2</sub> sensor does not reach operating temperature.   | Replace CO <sub>2</sub> sensor.<br>Replace CO <sub>2</sub> module.                                    |
| CO <sub>2</sub> sensor disconnected         | CO <sub>2</sub> sensor is not attached.  | —   |
| Y module disconnected                       | Y sensor module is not properly inserted.  | —   |
| Y module conflict                           | Two Y sensor modules are connected at the same time.   | Remove one Y module.  |
| Y sensor module error                       | Hardware error in the Y sensor module.   | Replace Y sensor module.  |
| Y sensor error                              | Hardware error in Y sensor   | Replace Y sensor  |
| Y sensor disconnected                       | Y sensor is not attached.  | —   |
| Y sensor disabled - flow too high           | Actual flow is higher than measurable flow.  | Check ventilator settings.<br>Disconnect Y sensor.  |

| Alarm message                           | Possible causes  | Alarm management checklist   |
|---|--|--|
| Y sensor disabled - flow unreliable     | The difference between the Y sensor reading and internally measured value is too high.   | Check Y sensor for condensation.   |
| Y sensor disabled - pressure unreliable | The difference between the Y sensor reading and internally measured value is too high.   | Check Y sensor pressure connection.  |
| Y sensor flow error                     | Hardware error in Y sensor.  | —  |
| Internal temperature too high           | Temperature inside the ventilator is too high.   | Replace the ventilator as soon as possible.  |
| Remote alarm internal error - TE: 46    | Technical problems with the external alarm function.   | Remote alarm inactive.<br>Replace the ventilator when convenient.  |
| Missing battery                         | Less than two batteries are installed.   | Insert missing batteries.<br>At least 2 batteries are required.  |
| Flow through expiratory tube            | Improper connection of patient circuit.<br>The high-flow nasal cannula may be connected to Y piece with expiratory tubing still connected to the ventilator. | Check patient circuit.<br>Connect high-flow nasal cannula or tracheostomy interface to the inspiratory tube. |

### 7.5.4 Low priority alarms

| Alarm message                 | Possible causes  | Alarm management checklist  |
|-------------------------------|--|---|
| Battery operation             | The mains power is interrupted.  | Check mains power connection.   |
| Edi module disconnected       | Edi module is not properly inserted.   | —   |
| Edi module error              | Hardware error in the Edi module.  | Replace the Edi module.   |
| Edi catheter error            | Error in the Edi catheter.   | Replace Edi catheter.   |
| Edi module conflict           | Two Edi modules are connected at the same time.  | Remove one Edi module.  |
| Volume delivery is restricted | The pressure is limited to 5 cmH <sub>2</sub> O below the set upper pressure limit, which restricts the volume delivery. | The pressure is limited to 5 cmH <sub>2</sub> O below the set upper pressure limit, which restricts the volume delivery.<br>Check ventilator settings.<br>Check alarm limits. |
| No Edi catheter connected     | The Edi catheter is not properly connected.  | Check Edi catheter connection.  |
| Edi monitoring not active     | NAVA mode is activated when no Edi module and/or Edi catheter is connected.  | Change ventilation mode.<br>Insert the Edi module.  |
| Expiratory cassette replaced  | The expiratory cassette has been replaced during operation. A pre-use check is not performed after the replacement.      | Perform a pre-use check.  |
| Cooling fan error - TE: 61    | Hardware error   | Replace the ventilator when convenient.   |

## 7.5.5 Technical error messages

### High priority alarms

| Error code number      | Possible causes                   | Alarm management checklist          |
|------------------------|-----------------------------------|-------------------------------------|
| 1 - 6                  | Internal power failure.           | Replace the ventilator immediately. |
| 10, 11                 | Control system error.             | Replace the ventilator immediately. |
| 37, 40001-40011        | Expiratory flowmeter error.       | Replace the ventilator immediately. |
| 7, 60                  | Internal error.                   | Replace the ventilator immediately. |
| 42, 44, 10003          | Internal memory error.            | Replace the ventilator immediately. |
| 16, 17, 25, 35, 43, 55 | Internal communication error.     | Replace the ventilator immediately. |
| 8, 9, 85               | Timeout error.                    | Replace the ventilator immediately. |
| 38, 39                 | Barometer sensor error.           | Replace the ventilator immediately. |
| 40                     | Monitored value not within range. | Replace the ventilator immediately. |

### Medium priority alarms

| Error code number | Possible causes                   | Alarm management checklist                                    |
|-------------------|-----------------------------------|---|
| 51                | On/Off switch error.              | Replace the ventilator as soon as it is safe for the patient. |
| 28, 20004         | Panel audible alarm error.        | Replace the ventilator as soon as it is safe for the patient. |
| 22, 24, 27        | Backup audible alarm error.       | Replace the ventilator as soon as it is safe for the patient. |
| 40                | Monitored value not within range. | Replace the ventilator as soon as it is safe for the patient. |
| 20002             | Backlight error.                  | Replace the ventilator as soon as it is safe for the patient. |

### Low priority alarms

| Error code number | Possible causes                 | Alarm management checklist              |
|-------------------|---------------------------------|---|
| 48                | Control system error.           | Replace the ventilator when convenient. |
| 41                | Internal clock error.           | Replace the ventilator when convenient. |
| 29                | Memory backup battery depleted. | Replace the ventilator when convenient. |
| 56 - 58           | Internal memory error.          | Replace the ventilator when convenient. |
| 10004             | Internal communication error.   | Replace the ventilator when convenient. |

## 7.6 Alarm output connection

If the ventilator system is equipped with the alarm output connection, alarms can be transferred to an external signalling system. The alarm output signal is active as long as the alarm audio is active on the ventilator system.

**WARNING!** Never leave the patient unattended. The external alarm is designed to alert those already in attendance.

**CAUTION:** Maquet cannot guarantee a distributed alarm system, according to IEC 60601-1-8, where the alarm output is a component. It is recommended that users establish a procedure to check this application before use.

## 8 Service & Settings

### Table of contents

|     |                 |     |
|-----|-----------------|-----|
| 8.1 | Introduction    | 164 |
| 8.2 | Biomed          | 164 |
| 8.3 | Service         | 169 |
| 8.4 | Remote Services | 170 |

## 8.1 Introduction

To access *SERVICE & SETTINGS*:

- Tap *SERVICE & SETTINGS* in the extended menu.

**Note:** The ventilator system must be in Standby.

The following choices are available:

- *BIOMED*
- *SERVICE*
- *REMOTE SERVICES*
- *LICENSES*
- *EXIT*

## 8.2 Biomed

*BIOMED* is used for viewing and editing the ventilator settings. The logs can also be managed.

Available options depend on the installed configuration.

To access *BIOMED*:

- Tap *BIOMED*.
- Enter the access code (the factory setting is 1973) and tap Accept.

The following choices are available:

- *STATUS*
- *LOGS*
- *SERVICE REPORT*
- *CONFIGURATION*
- *COPY CONFIGURATION*
- *INSTALLATION*
- *EXIT*

### 8.2.1 Status

*STATUS* is used for viewing system information, installed software options and software licensing conditions.

To access *System Info.*, *Options* and *SW license*:

- Tap *BIOMED/STATUS*

The following information is available for *System Info.*:

- *O<sub>2</sub> CELL/O<sub>2</sub> SENSOR*
- *EXPIRATORY CASSETTE*
- *BATTERY STATUS*

The following information is available for *Options*:

- *INSTALLED OPTIONS*

Tap *SW license* for lists of software components, versions and licensing conditions.



### 8.2.2 Logs

*LOGS* is used for viewing event logs for a certain period of time. A date interval can also be set and a search function is available.

To access *LOGS*:

- Tap *BIOMED/LOGS*.

The following search filters are available:

- *Alarms*
- *Functions*
- *Settings*
- *Configuration*

**Note:** Only a USB memory stick may be connected to the USB port.

### 8.2.3 Service report

*SERVICE REPORT* is used for reporting service tasks.

### 8.2.4 Configuration

*CONFIGURATION* is used for viewing and editing the startup configuration settings and alarms as well as for setting date and time and the biomed code.

To access *CONFIGURATION*:

- Tap *BIOMED/CONFIGURATION*.

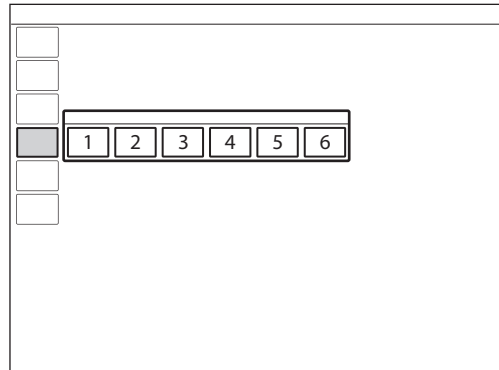

The following configurations can be viewed and edited:

1. *SETTINGS*
2. *STARTUP CONFIGURATION*
3. *ALARMS*
4. *NETWORK*
5. *SET DATE & TIME*
6. *BIOMED CODE*

## Settings

To access *SETTINGS*:

- Tap *BIOMED/CONFIGURATION/SETTINGS*.

The following items can be viewed and edited:

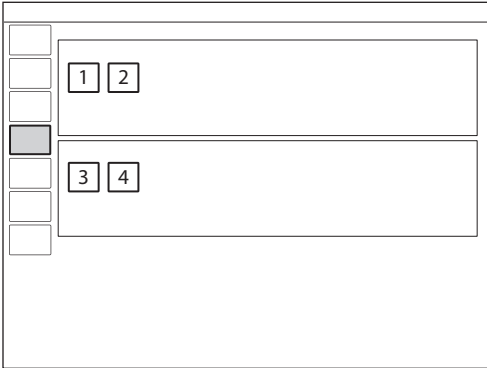

- **GENERAL**
  1. *Remote Services after pre-use check*
  2. *Type of measured pressure*
- **UNITS**
  1. *Height*
  2. *Weight*

## Startup Configuration

To access *STARTUP CONFIGURATION*:

- Tap *BIOMED/CONFIGURATION/STARTUP CONFIGURATION*.

The following items can be viewed and edited:

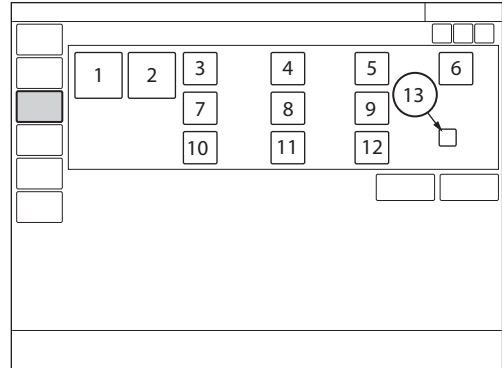

1. Patient category
2. Ventilation type (invasive or non invasive (NIV))
3. Volume setting (Tidal volume, Minute volume)
4. Breath cycle setting (I:E, Ti)
5. Temporary O<sub>2</sub> increase (%)
6. Deactivation of backup function (Not allowed, Allowed)
7. NIV disconnection functionality (Low flow, Disabled or High flow)
8. Extended leakage test (Off, On)
9. Use 0 (s) as default pause time (Off, On)
10. VC flow pattern setting available (On, Off)
11. Default VC flow pattern (%)
12. VC flow adaptation setting available (On, Off)
13. Default VC flow adaptation (with or without flow adaptation )

### Edit NIV disconnection function

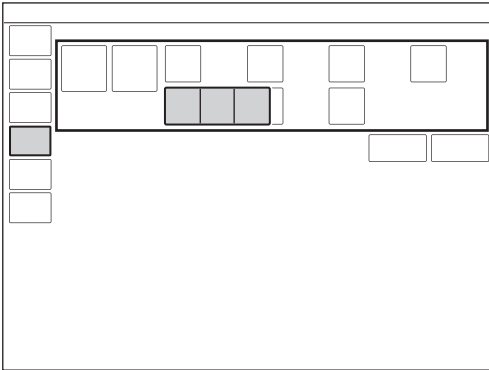

To edit the *NIV disconnection functionality*:

- Tap *CONFIGURATION/STARTUP CONFIGURATION/NIV disconnection functionality*.
- Choose *Low flow*, *Disabled* or *High flow*.

Refer to section Functions in ventilation modes on page 193.

### Edit Temporary O<sub>2</sub> increase (%)

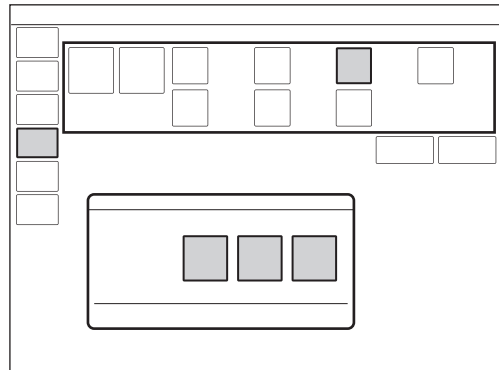

To edit the oxygenation concentration:

- Tap *CONFIGURATION/STARTUP CONFIGURATION/O<sub>2</sub>%* and adjust.

The setting entered in the window that opens determines the default setting for the *O<sub>2</sub> BOOST LEVEL* and the oxygen level increase during pre- and post-oxygenation when *DISCONNECTION/SUCTION* is used.

It does not affect the *O<sub>2</sub> BOOST LEVEL* function in the adult patient category where the default is 100 %.

**Important:** The ventilator system must be restarted to activate the new settings.

## Alarms

The alarm settings are the default settings that the ventilator system is delivered with. These defaults can be changed.

To access *ALARMS*:

- Tap *BIOMED/CONFIGURATION/ALARMS*.

The following alarm categories can be viewed and managed depending on the installed configuration:

1. Pediatric
2. Pediatric NIV
3. Neonatal
4. Neonatal NIV
5. Adult
6. Adult NIV
7. Alarm sound level
8. Restore default alarm limits

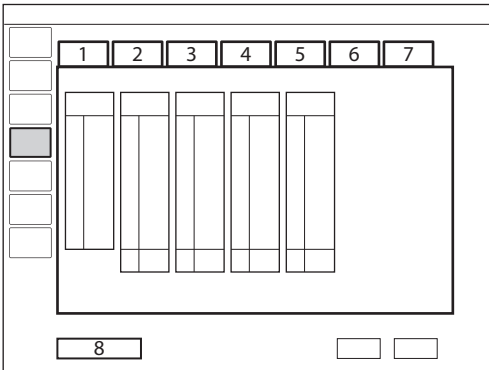

To change the alarm sound level, tap the *Alarm sound level* tab.

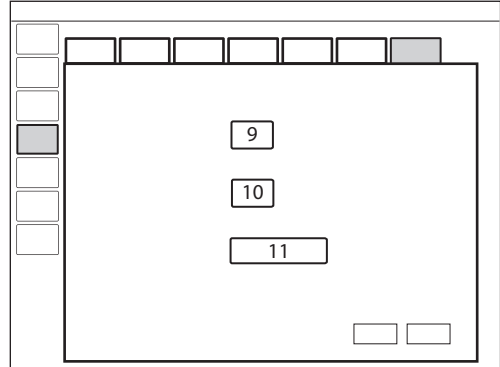

The following can be adjusted:

9. Default alarm sound level at start-up
10. Set minimum alarm sound level
11. Restore default audio level

Options to restore defaults, cancel or save changes are available for all alarms.

## Network

*NETWORK* is used to configure the settings for connecting to Remote Services.

To access *NETWORK*:

- Tap *BIOMED/CONFIGURATION/NETWORK*.

## Set date & time

Options to change the date and time are available.

To access *SET DATE & TIME*:

- Tap *BIOMED/CONFIGURATION/DATE & TIME*.

## Biomed Code

The current access code is displayed with an option to enter and save a new access code.

To access *BIOMED CODE*:

- Tap *BIOMED/CONFIGURATION/BIOMED CODE*.

## 8.2.5 Copy configuration

The configuration settings can be copied from or to a USB memory stick.

To access *COPY CONFIGURATION*:

- Tap *BIOMED/COPY CONFIGURATION*.

**Important:** Only a USB memory stick may be connected to the USB port.

**Note:** When the copy is complete, a message will be displayed on the screen.

## 8.2.6 Installation

*INSTALLATION* is used for viewing permanent options and installing new options.

To access *INSTALLATION*:

- Tap *BIOMED/INSTALLATION*.

## 8.3 Service

The Service menu should only be accessed by a trained service technician that has been certified by Maquet.

## 8.4 Remote Services

When in *STANDBY*, connect the network cable between the ventilator system and the network.

**CAUTION:** When using the MCare Remote Services function, instal the network cable so that there is no risk of anyone tripping over it.

To access *REMOTE SERVICES* :

- Tap *SERVICE & SETTINGS/REMOTE SERVICES* in the extended menu.

The following message appears:

- *Running*

When the transfer is complete, the following message appears:

- *Completed*
- Tap *OK*.

**Note:** The ventilator system is prepared for the MCare Remote Services functionality, although additional equipment is needed to use this function. Please contact the sales and service representative for more details.

## 9 Technical data

### Table of contents

|      |  |     |
|------|--|-----|
| 9.1  | System                                 | 172 |
| 9.2  | Ventilator system                      | 175 |
| 9.3  | Standard condition specification       | 176 |
| 9.4  | Essential performance                  | 177 |
| 9.5  | Patient circuit                        | 177 |
| 9.6  | Inspiratory channel                    | 179 |
| 9.7  | Expiratory channel                     | 180 |
| 9.8  | Monitoring                             | 181 |
| 9.9  | Ventilatory settings                   | 185 |
| 9.10 | Alarms                                 | 189 |
| 9.11 | Functions in ventilation modes         | 193 |
| 9.12 | NAVA                                   | 194 |
| 9.13 | Trends                                 | 195 |
| 9.14 | Logs                                   | 196 |
| 9.15 | Service                                | 197 |
| 9.16 | Aerogen nebulizer                      | 198 |
| 9.17 | CO <sub>2</sub> analyzer               | 200 |
| 9.18 | Y sensor                               | 203 |
| 9.19 | Communication/interface                | 204 |
| 9.20 | Accessories                            | 205 |
| 9.21 | Health and Environment                 | 207 |
| 9.22 | UDI Label                              | 208 |
| 9.23 | Information required by ISO 80601-2-12 | 209 |
| 9.24 | Technical description                  | 210 |

## 9.1 System

### General

#### Standards

- IEC 60601-1: 2005, Class I, continuous operation
- Applied parts
- Equipment making physical contact with the patient and the gas path ways. Type B
  - Edi catheter and cable. Type CF
  - CO<sub>2</sub> sensor. Type BF
  - Y sensor. Type BF
  - Nebulizer patient unit and cable. Type BF
- Applied parts, i.e. equipment making physical contact with the patient, are described in System Flow Chart, Ventilation, Patient Connection.
- ISO 80601-2-12:2011
  - ISO 80601-2-55:2011
  - EN 13544-1:2007 + A1:2009

#### Electromagnetic compatibility (EMC)

According to IEC 60601-1-2:2007  
The EMC declaration: *Information to the Responsible Organization* is available from Maquet.

#### Patient category

##### Tidal volume

- Neonatal: 2 - 50 ml
- Pediatric: 10 - 350 ml
- Adult: 100 - 4000 ml

##### Invasive ventilation

- Neonatal weight: 0.3 - 8 kg
- Pediatric weight: 3 - 30 kg
- Adult weight: 15 - 250 kg

##### Non invasive ventilation

- NIV (PC) neonatal weight: 3 - 8 kg
- NIV (PC) pediatric weight: 3 - 15 kg
- NIV (PC) adult weight: 15 - 250 kg
- NIV NAVA neonatal weight: 0.3 - 8 kg
- NIV NAVA pediatric weight: 3 - 15 kg
- NIV NAVA adult weight: 15 - 250 kg
- High Flow neonatal weight: 0.3 - 8 kg
- High Flow pediatric weight: 3 - 15 kg
- High Flow adult weight: 15 - 250 kg
- NIV Nasal CPAP neonatal weight: 0.3 - 8 kg
- NIV Nasal CPAP pediatric weight: 3 - 15 kg
- NIV Nasal CPAP adult weight: Not Applicable



| General                            |   |
|------------------------------------|---|
| Ingress protection                 | IP 21<br>The IP 21 classification implies that the enclosure is protected against solid foreign objects represented by a test finger with a diameter of 12 mm pressed with a force of 10 N, and a sphere with a diameter of 12.5 mm pressed with a force of 30 N against all openings in the enclosure, as well as dripping water with a flow rate of 1 mm/min for ten minutes. |
| Noise                              | <ul style="list-style-type: none"> <li>• A-weighted sound pressure level (<math>L_{pA}</math>): &lt;40 dB, measured at a distance of 1 m</li> <li>• A-weighted sound power level (<math>L_{WA}</math>): &lt;51 dB</li> </ul>  |
| Information signal                 | Single beep   |
| Operating Conditions               |   |
| Operating temperature range        | 10 to 40°C  |
| Relative humidity                  | 15 to 95 % non-condensing   |
| Atmospheric pressure               | 660 to 1060 hPa   |
| Lowest pressure in patient circuit | -400 cmH <sub>2</sub> O   |
| Non operating conditions           |   |
| Storage temperature                | -25 to +60° C (-13 to 140° F)   |
| Storage relative humidity          | < 95 % condensing   |
| Storage atmospheric pressure       | 470 to 1060 hPa   |

**Power supply**

Power supply, automatic range selection

Rated input power

- 100 V - 120 V AC, 2 A
- 220 V - 240 V AC, 1 A

Auto range

- 50 - 60 Hz
- Typical minimum power consumption (no optional modules, no ongoing battery charging, normal panel backlight): 100 VA, 40 W at 230 V or 75 VA, 40 W at 110 V
- Typical maximum power consumption (with CO<sub>2</sub>, Edi and Y sensor modules, ongoing battery charging, maximum panel backlight): 200 VA, 80 W at 230 V or 170 VA, 80 W at 110 V

Battery backup

- 2 - 6 battery modules rechargeable 12 V, 5 A, 3.5 Ah each
- Battery backup time at least 1 h (two batteries) to 3 h (six batteries) fully charged
- Recharge time approximately 3 h/battery (up to 12 hours if battery is completely discharged)

When the ventilator system is in storage, keep the ventilator system connected to mains power to maintain full charge in the batteries.

External 12 V DC

12.0 V – 15.0 V DC, 10 A

Fuse: 10 A/32 V Miniblade

**CAUTION:** When using external 12V DC, at least two installed battery modules are required to ensure proper operation.

Information regarding connector wiring is available from Maquet.

Battery disposal

Do not dispose of battery modules and O<sub>2</sub> cells with ordinary waste.

Battery lifetime

2.5 years from manufacturing date

## 9.2 Ventilator system

| General                        |  |
|--------------------------------|--|
| Dimensions                     | <ul style="list-style-type: none"> <li>User interface: W 366 x D 50 (90 with cable cover) x H 300 mm</li> <li>Patient unit: W 300 x D 205 x H 420 mm</li> <li>Patient unit with handle: W 435 x D 210 x H 530 mm</li> </ul>  |
| Weight, approximate            | <ul style="list-style-type: none"> <li>Total: 23 kg</li> <li>User interface (incl. cable holder and cable): 4 kg</li> <li>Patient unit (not incl. handle): 15 kg</li> <li>Cable holder and cable: 1 kg</li> <li>Handle: 3 kg</li> </ul>  |
| Gas supply                     |  |
| Gas quality                    | Supplied gases shall meet the requirements for medical grade gases according to applicable standards.  |
| Maximum levels                 | <p>Air</p> <ul style="list-style-type: none"> <li>H<sub>2</sub>O &lt; 7 g/m<sup>3</sup></li> <li>Oil &lt; 0.5 mg/m<sup>3</sup></li> <li>Chlorine: must not be detectable <sup>1</sup></li> </ul> <p>O<sub>2</sub></p> <ul style="list-style-type: none"> <li>H<sub>2</sub>O &lt; 20 mg/m<sup>3</sup></li> <li>Oil &lt; 0.3 mg/m<sup>3</sup></li> </ul> |
| Inlet gas                      | <p>Air/O<sub>2</sub></p> <ul style="list-style-type: none"> <li>Pressure: 2.0 – 6.0 kPa x 100 (29 – 87 psi)</li> <li>Maximum continuous flow 60 l/min</li> </ul>   |
| Connection standards available | AGA, DISS, NIST, or French   |
| Patient system connectors      |  |
| Conical fittings               | Nominal 22 mm and 15 mm, in accordance with ISO 5356-1   |
| Pressure line connector        | Gable mounted bulk head connector to fit tubings with an inner diameter of 3-4 mm  |
| Gas exhaust port               | Male 30 mm cone  |

1. If the compressed air is generated by a liquid ring compressor there is a potential risk of chlorine in the supplied air.

### 9.3 Standard condition specification

Inaccuracy ranges in this document assume the following standard conditions and the worst case, i.e. all errors are summarized positive.

| Standard condition specification |   |
|----------------------------------|---|
| Ambient pressure                 | 101.3 kPa   |
| Room temperature                 | 21°C  |
| Inlet pressure                   | 4.3 kPa x 100   |
| Pre-use check                    | <ul style="list-style-type: none"> <li>• Pre-use check performed on a warmed up ventilator system</li> <li>• Pre-use check performed with <math>\geq 99</math> % oxygen content in O<sub>2</sub> supply</li> <li>• Pre-use check performed with <math>21 \pm 0.5</math> % oxygen content in air supply (to ensure specified O<sub>2</sub> monitoring inaccuracy)</li> </ul> |
| Circuit compensation             | Circuit compensation is activated.  |
| Settings                         | Default settings unless otherwise specified   |
| I:E                              | Set I:E is less than 1:1.   |
| Ventilatory frequency            | Set ventilatory frequency is less than or equal to 100 breaths/minute.  |
| Leakage                          | <p>Constant leakage below 30 % in NIV modes.</p> <p>Constant leakage below 30 % for neonatal patient category in invasive modes with Y sensor measuring and leakage compensation activated.</p>   |
| BTPS                             | <p>All measured, preset and indicated flows and volumes are referenced to BTPS.</p> <p>Body Temperature and Pressure Saturated. All measured, preset and indicated flows and volumes at +37°C, local atmospheric pressure and relative humidity 100 % (saturated).</p>  |
| STPD                             | <p>All measured inlet gas pressures and flows are referenced to STPD.</p> <p>Standard Temperature and Pressure Dry. All measured, inlet gas pressures and flows at +20 °C (standard temperature), standard pressure 101.3 kPa and relative humidity 0 % (dry).</p>  |

## 9.4 Essential performance

The essential performance for the ventilator system and its options are the delivery of ventilation at the patient connection port within the alarm limits set by the user or generation of an alarm condition.

### Essential performance according to IEC 60601-1

|                       |  |
|-----------------------|--|
| Essential performance | <ul style="list-style-type: none"> <li>• Oxygen level alarm conditions</li> <li>• Airway pressure</li> <li>• Expired volume</li> <li>• Electrical supply failure</li> <li>• Internal electrical power source near depletion</li> <li>• Gas supply failure</li> </ul> |
|-----------------------|--|

---

## 9.5 Patient circuit

The patient circuit configurations are intended to provide the following range of inspired tidal volumes:

### Patient circuit configurations

|                                 |  |
|---------------------------------|--|
| Range of inspired tidal volumes | <ul style="list-style-type: none"> <li>• Neonatal/Pediatric: 10 - 12 mm tubing, tidal volumes 2 - 100 ml</li> <li>• Neonatal/Pediatric: 15 mm tubing, tidal volumes 25 - 350 ml</li> <li>• Adult: 22 mm tubing, tidal volumes 100 - 4000 ml</li> </ul> |
|---------------------------------|--|

---

Refer to System Flow Chart, Ventilation, Patient Connection for information regarding patient circuit configurations to be used with the ventilator system.

### 9.5.1 Patient circuit test

In the pre-use check, the patient circuit is tested to determine if it is within these recommended ranges. If the tested parameters are within the specified ranges, the inaccuracies stated are maintained.

#### Patient circuit test

|                        |   |
|------------------------|---|
| Inspiratory resistance | <ul style="list-style-type: none"> <li>• Neonatal/Pediatric: 0 - 31.0 cmH<sub>2</sub>O/l/s at flow rate 10 l/min</li> <li>• Adult: 0 - 7.7 cmH<sub>2</sub>O/l/s at flow rate 60 l/min</li> </ul>                                    |
| Expiratory resistance  | <ul style="list-style-type: none"> <li>• Neonatal/Pediatric: 0 - 27.0 cmH<sub>2</sub>O/l/s at flow rate 10 l/min</li> <li>• Adult: 0 - 5.0 cmH<sub>2</sub>O/l/s at flow rate 60 l/min</li> </ul>                                    |
| Compliance             | <ul style="list-style-type: none"> <li>• Neonatal/Pediatric: 0.2 - 1.4 ml/cmH<sub>2</sub>O at airway pressure 50 cmH<sub>2</sub>O</li> <li>• Adult: 0.7 - 2.4 ml/cmH<sub>2</sub>O at airway pressure 50 cmH<sub>2</sub>O</li> </ul> |

## 9.6 Inspiratory channel

| Inspiratory channel                      |  |
|--|--|
| Pressure drop                            | Maximum: 6 cmH <sub>2</sub> O at a flow of 60 l/min  |
| Internal compressible factor             | Maximum: 0.1 ml/cmH <sub>2</sub> O   |
| Gas delivery system                      | Microprocessor controlled valves   |
| Gas delivery device                      | <p>Flow range:</p> <ul style="list-style-type: none"> <li>• Neonatal: 0 - 33 l/min</li> <li>• Pediatric: 0 - 33 l/min</li> <li>• Adult: 0 - 200 l/min</li> </ul> <p>Inaccuracy: ±(6 ml/min + 5 % of set value)</p> <p>Maximum pressure setting:</p> <ul style="list-style-type: none"> <li>• Neonatal: 80 cmH<sub>2</sub>O</li> <li>• Pediatric: 80 cmH<sub>2</sub>O</li> <li>• Adult: 120 cmH<sub>2</sub>O</li> </ul> <p>Inaccuracy: ±(1 cmH<sub>2</sub>O +5 % of set value)</p>  |
| Maximum airway pressure                  | 125 cmH <sub>2</sub> O   |
| NIV max. leakage compensation level      | <ul style="list-style-type: none"> <li>• Neonatal: 25 l/min</li> <li>• Pediatric: 25 l/min</li> <li>• Neonatal: Nasal CPAP: 20 l/min</li> <li>• Pediatric: Nasal CPAP: 20 l/min</li> <li>• Adult: 65 l/min</li> </ul>  |
| Invasive max. leakage compensation level | Neonatal: 25 l/min   |
| O <sub>2</sub> concentration             | <ul style="list-style-type: none"> <li>• Setting range: 21 - 100 %</li> </ul> <p>Inaccuracy ± 3 vol%</p>   |
| Inspiratory tidal volume                 | <p>Air/O<sub>2</sub></p> <p>Setting range:</p> <ul style="list-style-type: none"> <li>• Neonatal: 2 - 50 ml</li> <li>• Pediatric: 10 - 350 ml</li> <li>• Adult: 100 - 4000 ml</li> </ul> <p>Inaccuracy:</p> <ul style="list-style-type: none"> <li>• Neonatal: ±(1 ml + 7 % of set volume)</li> <li>• Pediatric: <ul style="list-style-type: none"> <li>- VT &lt;50 ml: ±(2 ml + 7 % of set volume)</li> <li>- VT ≥50 ml: ±(4 ml + 7 % of set volume)</li> </ul> </li> <li>• Adult: ±(4 ml + 7 % of set volume)</li> </ul> |

| Inspiratory channel       |  |
|---------------------------|--|
| Inspiratory minute volume | Air/O <sub>2</sub><br>Setting range: <ul style="list-style-type: none"> <li>• Neonatal: 0.1 - 7.5 l/min</li> <li>• Pediatric: 0.3 - 20 l/min</li> <li>• Adult: 0.5 - 60 l/min</li> </ul> |
| High Flow therapy         | Flow setting range: <ul style="list-style-type: none"> <li>• Neonatal: 0.5 - 20 l/min</li> <li>• Pediatric: 0.5 - 30 l/min.</li> <li>• Adult: 5 - 60 l/min.</li> </ul> Inaccuracy ± 8 %  |

## 9.7 Expiratory channel

| Expiratory channel           |  |
|------------------------------|--|
| Pressure drop                | Maximum: 3 cmH <sub>2</sub> O at a flow of 60 l/min  |
| Internal compressible factor | Maximum: 0.1 ml/cmH <sub>2</sub> O   |
| PEEP regulation              | Microprocessor controlled valve  |
| PEEP setting range           | <ul style="list-style-type: none"> <li>• 1 - 50 cmH<sub>2</sub>O</li> </ul> Inaccuracy: ±(1 cmH <sub>2</sub> O + 5 % of set value) <sup>2</sup>  |
| Expiratory flow measurements | <ul style="list-style-type: none"> <li>• 0 - 192 l/min</li> <li>• Rise time (flow of 3 - 192 l/min): &lt;12 ms for 10 - 90 % response</li> </ul> |
| Bias flow during expiration  | <ul style="list-style-type: none"> <li>• Neonatal: 0.5 l/min ±8 %</li> <li>• Pediatric: 0.5 l/min ±8 %</li> <li>• Adult: 2 l/min ±5 %</li> </ul> |

2. PEEP accuracy may decrease for RR≥60 b/min together with VT ≤20 ml.



## 9.8 Monitoring

### Inspiratory Tidal Volume

In the neonatal patient category, when the tidal volume is below 10 ml, use of Y sensor or ventilation in NAVA mode is recommended.

| Monitoring               |   |
|--------------------------|---|
| Inspiratory tidal volume | Air/O <sub>2</sub><br>Range/Inaccuracy: <ul style="list-style-type: none"> <li>• Neonatal:               <ul style="list-style-type: none"> <li>±(2 ml + 12 % of actual volume) for VT 2 ml - 20 ml</li> <li>±(1.5 ml + 15 % of actual volume) for VT 20 ml - 50 ml</li> </ul> </li> <li>• Pediatric: ±(2.5 ml + 10 % of actual volume) for VT 10 ml - 350 ml</li> <li>• Adult: ±(4 ml + 7 % of actual volume) for VT 100 ml - 4000 ml</li> </ul> Range/Inaccuracy with Y sensor: <ul style="list-style-type: none"> <li>• Neonatal:               <ul style="list-style-type: none"> <li>±(1 ml + 7 % of actual volume) for VT 2 ml - 20 ml</li> <li>±(2 ml + 10 % of actual volume) for VT 20 ml - 50 ml</li> </ul> </li> <li>• Pediatric: ±(2 ml + 10 % of actual volume) for VT 10 ml - 350 ml</li> </ul> |
| Expiratory tidal volume  | Air/O <sub>2</sub><br>Range/Inaccuracy: <ul style="list-style-type: none"> <li>• Neonatal:               <ul style="list-style-type: none"> <li>±(2 ml + 12 % of actual volume) for VT 2 ml - 20 ml</li> <li>±(2.5 ml + 9 % of actual volume) for VT 20 ml - 50 ml</li> </ul> </li> <li>• Pediatric: ±(3 ml + 10 % of actual volume) for VT 10 ml - 350 ml</li> <li>• Adult: ±(4 ml + 8 % of actual volume) for VT 100 ml - 4000 ml</li> </ul> Range/Inaccuracy with Y sensor: <ul style="list-style-type: none"> <li>• Neonatal:               <ul style="list-style-type: none"> <li>±(1 ml + 7 % of actual volume) for VT 2 ml - 20 ml</li> <li>±(2.5 ml + 9 % of actual volume) for VT 20 ml - 50 ml</li> </ul> </li> <li>• Pediatric: ±(2.5 ml + 9 % of actual volume) for VT 10 ml - 350 ml</li> </ul>  |

**Monitoring**

|                                     |  |
|-------------------------------------|--|
| Expiratory minute volume            | <p>Air/O<sub>2</sub></p> <p>Range:</p> <ul style="list-style-type: none"> <li>• Neonatal: 0.3 - 20 l/min</li> <li>• Pediatric: 0.3 - 20 l/min</li> <li>• Adult: 0.5 - 60 l/min</li> </ul> <p>Inaccuracy:</p> <ul style="list-style-type: none"> <li>• Neonatal: <math>\pm(0.2 \text{ l/min} + 10 \% \text{ of actual value})</math><sup>3</sup></li> <li>• Pediatric: <math>\pm(0.2 \text{ l/min} + 9 \% \text{ of actual value})</math><sup>4</sup></li> <li>• Adult: <math>\pm(0.15 \text{ l/min} + 8 \% \text{ of actual value})</math><sup>5</sup></li> </ul> <p>Inaccuracy, NIV:</p> <ul style="list-style-type: none"> <li>• Neonatal: <math>\pm(0.2 \text{ l/min} + 10 \% \text{ of actual value})</math><sup>6</sup></li> <li>• Pediatric: <math>\pm(0.2 \text{ l/min} + 10 \% \text{ of actual value})</math><sup>7</sup></li> <li>• Adult: <math>\pm(0.15 \text{ l/min} + 10 \% \text{ of actual value})</math><sup>8</sup></li> </ul> |
| Respiratory rate                    | <ul style="list-style-type: none"> <li>• Range: 1 - 160 b/min</li> </ul> <p>Respiratory rate shall be measured with a maximum inaccuracy of <math>\pm 1</math> b/min.<br/>In Nasal CPAP, maximum inaccuracy shall be <math>\pm 10</math> % at tidal volumes <math>\geq 2</math> ml.</p>  |
| O <sub>2</sub> concentration        | <ul style="list-style-type: none"> <li>• Range: 0 – 100 %</li> </ul> <p>Inaccuracy: <math>\pm(2.5 \text{ vol}\% + 2.5 \% \text{ of actual gas concentration})</math></p> <ul style="list-style-type: none"> <li>• Stability (within 8-hour period): <math>\pm(2.5 \% \text{ volume} + 2.5 \% \text{ of actual gas concentration})</math></li> </ul> <p>The inaccuracy of the measurement is dependent on the oxygen content of the supplied gases during the pre-use check.</p>  |
| System response time O <sub>2</sub> | <p>The total system response time of the O<sub>2</sub> monitor when exposed first to air and then to a gas mix with 60 % O<sub>2</sub> is &lt;20 s.</p>  |
| Barometric pressure compensation    | Automatic  |
| Airway pressure                     | <ul style="list-style-type: none"> <li>• Range: -40 - 160 cmH<sub>2</sub>O</li> </ul> <p>Inaccuracy: <math>\pm(1 \text{ cmH}_2\text{O} + 5 \% \text{ of actual value})</math><sup>9</sup></p>  |
| Gas pressure                        | <ul style="list-style-type: none"> <li>• Range: 0 - 7 bar</li> </ul> <p>Inaccuracy: <math>\pm 5</math> % of read value</p>   |

3. at RR < 75 b/min

4. at RR < 75 b/min

5. at RR < 45 b/min

6. at RR < 75 b/min

7. at RR < 75 b/min

8. at RR < 45 b/min

9. PEEP accuracy may decrease for RR $\geq$ 60 b/min together with VT  $\leq$ 20 ml.







| Monitoring        |  |
|-------------------|--|
| Filtering         | <p>The measured and calculated values displayed or used for control have in some cases been subjected to filtering and smoothing techniques. This is done to capture the important patterns in the data while excluding noise and make the data shown clinically relevant. These techniques are part of the inaccuracy specified in the technical data.</p> <ul style="list-style-type: none"> <li>• Pressure waveform: Low pass filtered (time constant 15 ms)</li> <li>• CO<sub>2</sub> waveform: Low pass filtered (time constant 15 ms)</li> </ul> |
| High Flow therapy | <ul style="list-style-type: none"> <li>• Range: 0 - 60 l/min</li> </ul> <p>Inaccuracy: <math>\pm(1 \text{ l/min} + 5 \% \text{ of actual value})</math></p>  |







### 9.8.1 Pre-use check tests







| Test                            | Description  | Remedy if test fails  |
|---------------------------------|--|---|
| <i>Internal test</i>            | Audio test and other internal tests (memory and safety-related hardware).  | Contact a service technician.   |
| <i>Barometer test</i>           | Checks the barometric pressure measured by the internal barometer.   | Check the barometric pressure value in the extended menu <i>Status/System Info</i> window.  |
| <i>Gas supply test</i>          | Checks that the gas supply pressures (air and O <sub>2</sub> ) measured by the internal gas supply pressure transducers are within the specified range. The test checks the presence of different gas types. | Check that the gas supply pressure (air/O <sub>2</sub> ) is within the specified range, and that the gas used is approved for the ventilator system.<br>Refer to section Gas supply on page 175.  |
| <i>Internal leakage test</i>    | Checks for internal leakage, with test tube connected, using the inspiratory and expiratory pressure transducers.<br>Allowed leakage: 10 ml/min at 80 cmH <sub>2</sub> O.                                    | If message <i>Leakage</i> or <i>Excessive leakage</i> appears: <ul style="list-style-type: none"> <li>• check that the test tube is correctly connected,</li> <li>• check all connections for the expiratory cassette and inspiratory channel,</li> <li>• make sure the expiratory cassette and the inspiratory channel are clean and dry, OR</li> <li>• contact a service technician.</li> </ul> |
| <i>Pressure transducer test</i> | Calibrates and checks the inspiratory and expiratory pressure transducers.   | If the Internal leakage test passed (see above): <ul style="list-style-type: none"> <li>• check that there is no excess water in the expiratory cassette</li> <li>• check/replace inspiratory or expiratory pressure transducer</li> </ul>  |







| Test                                  | Description  | Remedy if test fails  |
|---------------------------------------|--|---|
| <i>Safety valve test</i>              | Checks and if necessary adjusts the opening pressure for the safety valve to $117 \pm 3 \text{ cmH}_2\text{O}$ .   | <p>Check the inspiratory section:</p> <ul style="list-style-type: none"> <li>• check that the safety valve closes properly when the pre-use check is started (distinct clicking sound from the valve)</li> <li>• check that the safety valve membrane is correctly seated in the inspiratory pipe</li> <li>• check that the inspiratory pipe is correctly mounted in inspiratory section</li> </ul> |
| <i>O<sub>2</sub> cell/sensor test</i> | <p>Calibrates and checks the O<sub>2</sub> cell/sensor at 21 % O<sub>2</sub> and 100 % O<sub>2</sub>.</p> <p>Checks if the O<sub>2</sub> cell is worn out.</p> <p>Because different gas mixtures are required for this test, it will not be performed if one gas is missing.</p>   | <ul style="list-style-type: none"> <li>• Check that the connected gas supply pressure (air and O<sub>2</sub>) is within the specified range.</li> <li>• Replace the O<sub>2</sub> cell/sensor.</li> <li>• Replace gas modules (air and/or O<sub>2</sub>).</li> </ul>  |
| <i>Flow transducer test</i>           | If one gas is missing, no calibration of the expiratory flow transducer will be performed.   | <ul style="list-style-type: none"> <li>• Check that the connected gas supply pressure (air and O<sub>2</sub>) is within the specified range.</li> <li>• Check that the cassette is correctly seated in the cassette compartment.</li> </ul>   |
| <i>Battery switch test</i>            | If battery modules are installed, tests switching to battery power when AC power is lost and back to AC power when it is restored.   | Check that the total remaining time for the connected battery modules are at least 10 minutes. If not, replace the discharged battery with a fully charged battery and repeat the test.   |
| <i>Patient circuit test</i>           | <p>Checks the patient circuit leakage, compliance and resistance, with patient tubing connected, using the inspiratory and expiratory pressure transducers.</p> <p>Allowed leakage: 80 ml/min at 50 cmH<sub>2</sub>O.</p> <p>Will allow the system to calculate a compensation for circuit compliance (if the leakage requirements are met).</p> <p>For ranges and accuracies, see section Patient circuit test on page 178.</p> | If the internal leakage test has passed, the leakage is located in the patient circuit. Check for leakage or replace the patient circuit.   |
| <i>Y sensor calibration</i>           | Checks the pressure and flow measurement of the Y sensor.  | Check Y sensor module and Y sensor. If the problem persists, change the Y sensor/Y sensor module.   |
| <i>Alarm state test</i>               | Checks that no Technical error alarms are active during the pre-use check.   | Refer to service technician.  |
| <i>Alarm output connection</i>        | Checks that the alarm activation functions correctly.  | <ul style="list-style-type: none"> <li>• Check that the cable is connected to the external system.</li> <li>• Refer to service technician.</li> </ul>   |

## 9.9 Ventilatory settings

| Settings  | Factory set default values<br>(Standard configuration)                            |   |   | Setting range   |  |   |
|---|---|---|---|---|--|---|
|   |  |  |  |  |  |  |
| Maximum apnea time in Automode (s)  | 3   | 3   | 7   | 3 - 15  | 3 - 15   | 7 - 12  |
| Breath cycle time, SIMV (s)   | 1   | 1   | 4   | 0.5 - 15  | 0.5 - 15   | 1 - 15  |
| Respiratory rate (b/min)  | 50  | 30  | 15  | 4 - 150   | 4 - 150  | 4 - 100   |
| Circuit compensation<br><b>Note:</b> Circuit compensation is not available in NIV.                  | ON  | ON  | ON  | ON/OFF  | ON/OFF   | ON/OFF  |
| CPAP (cmH <sub>2</sub> O) in NIV Nasal CPAP   | 5   | 5   | —   | 2 - 20  | 2 - 20   | —   |
| Edi Trigger (µV)  | 0.5   | 0.5   | 0.5   | 0.1 - 2   | 0.1 - 2  | 0.1 - 2   |
| Flow trigger level in invasive modes, (l/min)<br><b>Note:</b> Flow trigger is not available in NIV. | 0.4   | 0.4   | 1.6   | 0 - 0.5   | 0 - 0.5  | 0 - 2   |
| I:E ratio   | 1:2   | 1:2   | 1:2   | 1:10 - 4:1  | 1:10 - 4:1   | 1:10 - 4:1  |
| I:E ratio in backup   | 1:2   | 1:2   | 1:2   | 1:10 - 4:1  | 1:10 - 4:1   | 1:10 - 4:1  |
| End inspiration (% of peak flow)  | 50  | 30  | 30  | 1 - 70  | 1 - 70   | 1 - 70  |
| End inspiration (% of peak flow) in NIV   | —   | 30  | 50  | 10 - 70   | 10 - 70  | 10 - 70   |
| Inspiratory rise time (%)   | 5   | 5   | 5   | 0 - 20  | 0 - 20   | 0 - 20  |

| Settings  | Factory set default values<br>(Standard configuration)                            |   |   | Setting range   |  |   |
|---|---|---|---|---|--|---|
|   |  |  |  |  |  |  |
| Inspiratory rise time (s)                                       | 0.15  | 0.15  | 0.15  | 0 - 0.2   | 0 - 0.2  | 0 - 0.4   |
| Inspiratory rise time (s) in NIV                                | 0.15  | 0.15  | 0.2   | 0 - 0.2   | 0 - 0.2  | 0 - 0.4   |
| Leakage compensation in invasive modes except Bi-Vent/APRV      | ON  | —   | —   | ON/OFF  | —  | —   |
| Maximum permitted absolute pressure (cmH <sub>2</sub> O)        | 80  | 80  | 120   | —   | —  | —   |
| Maximum permitted absolute pressure in NIV (cmH <sub>2</sub> O) | 62  | 62  | 62  | —   | —  | —   |
| Minute volume (l/min)   | 0.7   | 2.4   | 6   | 0.1 - 7.5   | 0.3 - 20   | 0.5-60  |
| NAVA level (cmH <sub>2</sub> O/μV)                              | 1   | 1   | 1   | 0 - 15  | 0 - 15   | 0 - 15  |
| NAVA level in NIV (cmH <sub>2</sub> O/μV)                       | 0.5   | 0.5   | 0.5   | 0 - 15  | 0 - 15   | 0 - 15  |
| Nebulizer   | OFF   | OFF   | OFF   | ON/OFF  | ON/OFF   | ON/OFF  |
| Nebulizer time (min)  | 10  | 10  | 10  | 5 - 30, continuous nebulization   | 5 - 30, continuous nebulization  | 5 - 30, continuous nebulization   |
| O <sub>2</sub> boost level (%)                                  | 30  | 30  | 30  | 0 - 79  | 0 - 79   | 0 - 79  |
| O <sub>2</sub> concentration (%)                                | 25  | 40  | 40  | 21 - 100  | 21 - 100   | 21 - 100  |
| PEEP (cmH <sub>2</sub> O)                                       | 5   | 5   | 8   | 1 - 50  | 1 - 50   | 1 - 50  |
| PEEP in NIV (cmH <sub>2</sub> O)                                | 5   | 5   | 5   | 2 - 20  | 2 - 20   | 2 - 20  |
| P <sub>high</sub> (cmH <sub>2</sub> O)                          | 15  | 15  | 15  | 2 - 50  | 2 - 50   | 2 - 50  |







| Settings  | Factory set default values<br>(Standard configuration)                            |   |   | Setting range   |  |   |
|---|---|---|---|---|--|---|
|   |  |  |  |  |  |  |
| Pressure trigger level (cmH <sub>2</sub> O)                     | —   | —   | —   | -1 - -20  | -1 - -20   | -1 - -20  |
| Pressure level above PEEP (cmH <sub>2</sub> O)                  | 10  | 10  | 15  | 0 - 80  | 0 - 80   | 0 - 120   |
| Pressure level above PEEP in NIV (cmH <sub>2</sub> O)           | 5   | 5   | 5   | 0 - 60  | 0 - 60   | 0 - 60  |
| Pressure level above PEEP in backup (cmH <sub>2</sub> O)        | 10  | 10  | 15  | 5 - 80  | 5 - 80   | 5 - 120   |
| Pressure level above PEEP in NIV backup (cmH <sub>2</sub> O)    | 5   | 5   | 5   | 5 - 60  | 5 - 60   | 5 - 60  |
| PS above PEEP in Bi-Vent/APRV (cmH <sub>2</sub> O)              | 0   | 0   | 0   | 0 - 80  | 0 - 80   | 0 - 120   |
| PS above P <sub>high</sub> in Bi-Vent/APRV (cmH <sub>2</sub> O) | 0   | 0   | 0   | 0 - 78  | 0 - 78   | 0 - 118   |
| Respiratory rate in backup                                      | 50  | 30  | 15  | 4 - 150   | 4 - 150  | 4 - 100   |
| SIMV frequency (b/min)  | 20  | 20  | 5   | 1 - 60  | 1 - 60   | 1 - 60  |
| T <sub>high</sub> (s)   | 1   | 1   | 2   | 0.2 - 30  | 0.2 - 30   | 0.2 - 30  |
| T <sub>i</sub> (s)  | 0.4   | 0.5   | 0.9   | 0.1 - 5   | 0.1 - 5  | 0.1 - 5   |
| T <sub>i</sub> in backup (s)                                    | 0.4   | 0.5   | 0.9   | 0.1 - 5   | 0.1 - 5  | 0.1 - 5   |
| Tidal volume (ml)   | 14  | 80  | 400   | 2 - 50  | 10 - 350   | 100 - 4000  |
| Tidal volume in backup (ml)                                     | 14  | 80  | 400   | 2 - 50  | 10 - 350   | 100 - 4000  |
| T <sub>pause</sub> (%)  | —   | 10  | 10  | —   | 0 - 30   | 0 - 30  |
| T <sub>pause</sub> (s)  | —   | 0   | 0   | —   | 0 - 1.5  | 0 - 1.5   |

| Settings            | Factory set default values<br>(Standard configuration)                            |   |   | Setting range   |  |   |
|---------------------|---|---|---|---|--|---|
|                     |  |  |  |  |  |  |
| TPEEP (s)           | 1   | 1   | 2   | 0.1 - 10  | 0.1 - 10   | 0.1 - 10  |
| VC Flow pattern (%) | —   | 100   | 100   | -   | 0-100  | 0-100   |
| Weight (kg)         | —   | —   | —   | 0.2 - 10  | 2 - 100  | 10 - 250  |



## 9.10 Alarms

### 9.10.1 Alarm limits

| Parameter  | Factory set default   |   |   | Setting range   |   |   | Audio Off (only for NIV)   |
|--|---|---|---|---|---|---|--|
|  |  |  |  |  |  |  |  |
| Airway pressure, upper limit (cmH <sub>2</sub> O) <sup>10</sup>                      | 40  | 40  | 40  | 16 - 90   | 16 - 90   | 16 - 120  | —  |
| Airway pressure, upper limit (cmH <sub>2</sub> O) in NIV <sup>11</sup>               | 25  | 25  | 25  | 16 - 70   | 16 - 70   | 16 - 70   | No   |
| Apnea time to alarm (s)  | 10  | 10  | 20  | 1 - 45  | 2 - 45  | 15 - 45   | No   |
| Apnea audio delay  | 0   | —   | —   | 0 - 30  | —   | —   | —  |
| Inspiratory tidal volume too high (ml) <sup>12</sup> Neonatal patient category only. | 20  | —   | —   | 2 - 70  | —   | —   | No   |
| Nasal CPAP upper limit (cmH <sub>2</sub> O)  | 7   | 7   | —   | 1 - 25  | —   | —   | Yes  |
| Nasal CPAP lower limit (cmH <sub>2</sub> O) <sup>13</sup>                            | 3   | 3   | —   | 0 - 24  | —   | —   | Yes  |
| End expiratory pressure, upper limit (cmH <sub>2</sub> O)                            | 15  | 15  | 15  | 1 - 55  | 1 - 55  | 1 - 55  | Yes  |
| End expiratory pressure, lower limit (cmH <sub>2</sub> O) <sup>14</sup>              | 2   | 2   | 2   | 0 - 47 <sup>15</sup>  | 0 - 47  | 0 - 47  | Yes  |
| Expired minute volume, lower limit (l/min)   | 1   | 2   | 5   | 0.01-20   | 0.01-20   | 0.5 - 40  | Yes. Audio off is also available in invasive modes in neonatal patient category. |

10. If P<sub>aw</sub> rises 6 cmH<sub>2</sub>O above the set limit or if system pressure exceeds 117 ±7 cmH<sub>2</sub>O, the safety valves opens.







11. If P<sub>aw</sub> rises 6 cmH<sub>2</sub>O above the set limit or if system pressure exceeds 117 ±7 cmH<sub>2</sub>O, the safety valves opens.

12. This alarm is only possible to set in PS, PC Automode PC ≥ PS and SIMV (PC)+PS. For PRVC and VS, the alarm limit is not adjustable and set to VT<sub>i</sub> + 60 %. Not applicable in NAVA or Bi-Vent/APRV.

13. Setting the alarm limit to 0 (zero) is equivalent to turning off the alarm.







14. Setting the alarm limit to 0 (zero) is equivalent to turning off the alarm.

15. Setting the alarm limit to 0 (zero) is equivalent to turning off the alarm.

| Parameter  | Factory set default   |   |   | Setting range   |   |   | Audio Off (only for NIV) |
|--|---|---|---|---|---|---|--------------------------|
|  |  |  |  |  |  |  |                          |
| Expired minute volume, upper limit (l/min)               | 5   | 5   | 40  | 0.02 - 30   | 0.02 - 30   | 1 - 60  | Yes                      |
| Respiratory rate, lower limit (b/min)                    | 30  | 20  | 5   | 1 - 159   | 1 - 159   | 1 - 159   | Yes                      |
| Respiratory rate, upper limit (b/min)                    | 60  | 50  | 30  | 2 - 160   | 2 - 160   | 2 - 160   | Yes                      |
| etCO <sub>2</sub> Lower alarm limit                      |   |   |   |   |   |   |                          |
| %  | 4   | 4   | 4   | 0.5 - 19.9  | 0.5 - 19.9  | 0.5 - 19.9  | —                        |
| mmHg   | 30  | 30  | 30  | 4 - 99  | 4 - 99  | 4 - 99  | —                        |
| kPa  | 4   | 4   | 4   | 0.5 - 13.9  | 0.5 - 13.9  | 0.5 - 13.9  | —                        |
| etCO <sub>2</sub> Lower alarm limit in NIV <sup>16</sup> |   |   |   |   |   |   |                          |
| %  | 4   | 4   | 4   | 0 - 19.9  | 0 - 19.9  | 0 - 19.9  | Yes                      |
| mmHg   | 30  | 30  | 30  | 0 - 99  | 0 - 99  | 0 - 99  | Yes                      |
| kPa  | 4   | 4   | 4   | 0 - 13.9  | 0 - 13.9  | 0 - 13.9  | Yes                      |
| etCO <sub>2</sub> Upper alarm limit <sup>17</sup>        |   |   |   |   |   |   |                          |
| %  | 6.5   | 6.5   | 6.5   | 0.6 - 20  | 0.6 - 20  | 0.6 - 20  | Yes                      |
| mmHg   | 49  | 49  | 49  | 5 - 100   | 5 - 100   | 5 - 100   | Yes                      |
| kPa  | 6.5   | 6.5   | 6.5   | 0.6 - 14  | 0.6 - 14  | 0.6 - 14  | Yes                      |
| etCO <sub>2</sub> Upper alarm limit in NIV               |   |   |   |   |   |   |                          |
| %  | 6.5   | 6.5   | 6.5   | 0.6 - 20  | 0.6 - 20  | 0.6 - 20  | Yes                      |
| mmHg   | 49  | 49  | 49  | 4 - 100   | 4 - 100   | 4 - 100   | Yes                      |
| kPa  | 6.5   | 6.5   | 6.5   | 0.6 - 14  | 0.6 - 14  | 0.6 - 14  | Yes                      |
| O <sub>2</sub> concentration, lower alarm limit (vol%)   | Set value -5 vol% or ≤18 vol%   |   |   | —   | —   | —   | No                       |
| O <sub>2</sub> concentration, upper alarm limit (vol%)   | Set value +5 vol%   |   |   | —   | —   | —   | No                       |

16. In NIV low limit can be set to 0 (zero)

17. If the alarm limit is set outside the measuring range, no alarm will be activated even if the limit is exceeded.

| Parameter                      | Factory set default   |   |   | Setting range   |   |   | Audio Off (only for NIV) |
|--------------------------------|---|---|---|---|---|---|--------------------------|
|                                |    |  |  |  |  |  |                          |
| Gas supply, Air/O <sub>2</sub> | <2.0 kPa x 100 or >6.0 kPa x 100  |   |   | —   | —   | —   | —                        |
| High continuous pressure       | Obstruction leading to constant high airway pressure (>PEEP +15 cmH <sub>2</sub> O) during: <ul style="list-style-type: none"> <li>• &gt; 2 breaths or 5 s, whichever is greater,</li> <li>• 15 ±1.5 s if less than 2 breaths are triggered)</li> </ul> |   |   | —   | —   | —   | No                       |

Always make sure relevant values are set.

Refer to section Conditions leading to default alarm settings on page 146.

### 9.10.2 Autoset alarm limits - controlled modes only

| Autoset alarm limits - controlled modes only                |   |
|---|---|
| High airway pressure  | Mean peak pressure +10 cmH <sub>2</sub> O or at least 35 cmH <sub>2</sub> O |
| Inspiratory tidal volume too high <sup>18</sup>             | The greater of VT <sub>i</sub> + 30 % or VT <sub>i</sub> + 2 ml             |
| Expiratory minute volume (upper alarm limit)                | Mean expiratory minute volume + 50 %  |
| Expiratory minute volume (lower alarm limit)                | Mean expiratory minute volume - 50 %  |
| Respiratory rate (upper alarm limit)                        | Mean respiratory rate + 40 %  |
| Respiratory rate (lower alarm limit)                        | Mean respiratory rate - 40 %  |
| End expiratory pressure (upper alarm limit)                 | Mean end expiratory pressure + 5 cmH <sub>2</sub> O                         |
| End expiratory pressure (lower alarm limit)                 | Mean end expiratory pressure - 3 cmH <sub>2</sub> O                         |
| End-tidal CO <sub>2</sub> concentration (upper alarm limit) | Mean end-tidal CO <sub>2</sub> concentration +25 %                          |
| End-tidal CO <sub>2</sub> concentration (lower alarm limit) | Mean end-tidal CO <sub>2</sub> concentration -25 %                          |

### 9.10.3 Alarms miscellaneous

| Alarms miscellaneous  |   |
|---|---|
| Audio pause (Alarm silenced)  | Two-minute silence  |
| Apnea audio delay (only available in the neonatal patient category) | 0 - 30 s  |
| Alarm sound level   | <p>The alarm sound level can be set in 10 steps (to between 55-85 dB(A) ±6 dB(A))</p> <ul style="list-style-type: none"> <li>• High priority alarm: A sequence of 3 + 2 beeps, short pause, 3 + 2 beeps, long pause</li> <li>• Medium priority alarm: A sequence of 3 beeps, long pause</li> <li>• Low priority alarm: A sequence of 2 beeps, long pause</li> </ul> |

18. Autoset is available only in PC in neonatal patient category.

## 9.11 Functions in ventilation modes

### Functions in ventilation modes and therapies

|   |  |
|---|--|
| Maximum inspiration time                                  | <ul style="list-style-type: none"> <li>• Neonatal: 1.0 s</li> <li>• Pediatric: 1.5 s</li> <li>• Adult: 2.5 s</li> </ul>  |
| NIV disconnection flow                                    | <p><b>Neonatal</b></p> <ul style="list-style-type: none"> <li>• Low flow: 7.5 l/min</li> <li>• High flow: 15 l/min</li> <li>• Disabled: the ventilator system will continue to deliver assist even when leakage is excessive.</li> </ul> <p><b>Pediatric</b></p> <ul style="list-style-type: none"> <li>• Low flow: 7.5 l/min</li> <li>• High flow: 15 l/min</li> <li>• Disabled: the ventilator system will continue to deliver assist even when leakage is excessive.</li> </ul> <p><b>Adult</b></p> <ul style="list-style-type: none"> <li>• Low flow: 7.5 l/min</li> <li>• High flow: 40 l/min</li> <li>• Disabled: the ventilator system will continue to deliver assist even when leakage is excessive.</li> </ul> |
| High Flow therapy - High inspiratory pressure alarm limit | <ul style="list-style-type: none"> <li>• Neonatal 40 cmH<sub>2</sub>O</li> <li>• Pediatric 50 cmH<sub>2</sub>O</li> <li>• Adult 60 cmH<sub>2</sub>O</li> </ul>   |

## 9.12 NAVA

| NAVA   |  |
|--|--|
| Size   | Edi module: L 154 x W 90 x H 21 mm   |
| Cable  | 2.0 m  |
| Edi catheter size  | <ul style="list-style-type: none"> <li>• 16 Fr 125 cm</li> <li>• 12 Fr 125 cm</li> <li>• 8 Fr 125 cm</li> <li>• 8 Fr 100 cm</li> <li>• 8 Fr 50 cm</li> <li>• 6 Fr 50 cm</li> <li>• 6 Fr 49 cm</li> </ul> |
| Definitions:   |  |
| <ul style="list-style-type: none"> <li>• <math>Edi_{peak\ average}</math></li> </ul> | <p>Average <math>Edi_{peak}</math><br/>                     The mean value of the <math>Edi_{peak}</math> for all breaths during the last 60 s.</p>  |
| <ul style="list-style-type: none"> <li>• <math>Edi_{min\ average}</math></li> </ul>  | <p>Average <math>Edi_{min}</math><br/>                     The mean value of the <math>Edi_{min}</math> for all breaths during the last 60 s.</p>  |

## 9.13 Trends

|  |                            |
|--|----------------------------|
| Peak airway pressure                                   | $P_{\text{peak}}$          |
| Pause airway pressure                                  | $P_{\text{plat}}$          |
| Mean airway pressure                                   | $P_{\text{mean}}$          |
| Driving pressure                                       | $P_{\text{drive}}$         |
| Positive end expiratory pressure                       | PEEP                       |
| Continuous positive airway pressure                    | CPAP                       |
| Spontaneous breaths per minute                         | $RR_{\text{sp}}$           |
| Respiratory rate                                       | RR                         |
| Spontaneous expiratory minute volume                   | $MV_{\text{e sp}}$         |
| Inspired minute volume                                 | $MV_{\text{i}}$            |
| Expired minute volume                                  | $MV_{\text{e}}$            |
| Leakage (%)  | Leakage                    |
| Inspired tidal volume                                  | $VT_{\text{i}}$            |
| Expired tidal volume                                   | $VT_{\text{e}}$            |
| End expiratory flow                                    | $\text{Flow}_{\text{ee}}$  |
| Measured oxygen concentration                          | $O_2 \text{ conc.}$        |
| $CO_2$ end tidal concentration                         | $\text{etCO}_2$            |
| $CO_2$ minute elimination                              | $V_{\text{CO}_2}$          |
| $CO_2$ tidal elimination                               | $VT_{\text{CO}_2}$         |
| Dynamic compliance                                     | $C_{\text{dyn}}$           |
| Static compliance                                      | $C_{\text{static}}$        |
| Inspiratory resistance                                 | $R_{\text{i}}$             |
| Expiratory resistance                                  | $R_{\text{e}}$             |
| Work of breathing, ventilator                          | $\text{WOB}_{\text{vent}}$ |
| Work of breathing, patient                             | $\text{WOB}_{\text{pat}}$  |
| Elastance  | E                          |
| P 0.1  | P 0.1                      |
| Shallow Breathing Index                                | SBI                        |
| Peak Edi value   | $\text{Edi}_{\text{peak}}$ |
| Minimum Edi value                                      | $\text{Edi}_{\text{min}}$  |
| Ratio of expired tidal volume to predicted body weight | $VT/PBW$                   |
| Switch to backup (/minute)                             | $\text{Backup } \Sigma$    |
| Backup (%/min)   | Backup %                   |

## 9.14 Logs

### 9.14.1 Event log

The following events are logged:

- Activation of alarms
- Calibration results
- Alarm limit changes
- Ventilator settings
- Apnea periods
- Pre-use checks
- Manual breath
- O<sub>2</sub> boost
- Inspiratory hold
- Expiratory hold
- Activation/deactivation of circuit compensation
- Connection/disconnection of CO<sub>2</sub> module/sensor
- Full calibration/zero offset adjustment of CO<sub>2</sub> sensor
- Connection/disconnection of Y sensor module
- Activation/deactivation of Y sensor measurement
- Connection/disconnection of Edi module/catheter
- Test of Edi module
- Turning backup on/off
- Operator initiated return from backup to supported ventilation
- Automatic return from backup to supported ventilation
- Disconnection and reconnection of patient
- Activation/deactivation of nebulization
- Deactivation of backup ventilation

- Activation/deactivation of invasive leakage compensation

### 9.14.2 Diagnostic log

The following items are logged:

- Technical information
- Test results
- Service records
- Software installation
- Configuration information



## 9.15 Service

### **WARNINGS!**

- Preventive maintenance must be performed by authorized personnel at least once a year or after every 5000 hours of operation. The time to next preventive maintenance is displayed from the extended menu, *SYSTEM STATUS* window.
- Service, repair and installation must be performed by Maquet authorized personnel only.
- Service and settings should only be used without a patient connected to the ventilator system.

### **CAUTIONS:**

- All technical documentation is available for use by Maquet authorized personnel.
- Information regarding assembling the system or options to obtain a proper mechanical assembly is available from Maquet.
- Original parts from Maquet must be used.
- Disconnect the mains power cable from the outlet to isolate the ventilator system from mains power.

## 9.16 Aerogen nebulizer

### 9.16.1 Aerogen Pro nebulizer

| Aerogen Pro nebulizer |   |
|-----------------------|---|
| Weight                | Approximate 25 g  |
| Dimensions            | W 50 x L 50 x H 45 mm   |
| Particle size, graph  | Representative particle size distribution for Salbutamol (Albuterol) as per EN 13544-1. |

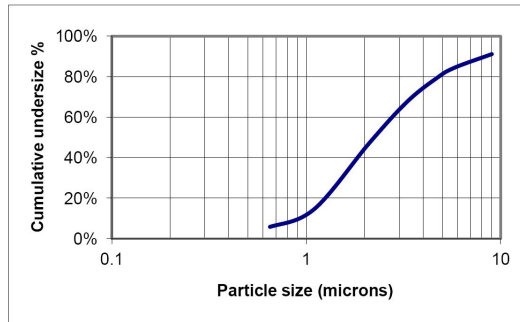

As measured with the Anderson Cascade Impactor:

1 - 5  $\mu\text{m}$ .

Average tested

3.1  $\mu\text{m}$

As measured with the Marple 298 Cascade Impactor:

1.5 - 6.2  $\mu\text{m}$ .

Average tested

3.9  $\mu\text{m}$

Flow rate

>0.2 (average: ~0.4) ml/min

Max volume, medication cup

10 ml

Residual volume

<0.1 ml for 3 ml dose

Control cable

1.8 m

Aerosol output rate

0.24 ml/min with starting dose 2 ml

Aerosol output

1.08 ml with starting dose 2 ml

Medication temperature

The temperature of the medication will not rise more than 10°C (18°F) above ambient temperature during normal use.

Lifetime

One year based on a typical usage profile of four treatments per day and one sterilization per week where the device is assumed to be in service for 50 % of the time. If this service pattern is exceeded, it may reduce the life of the product.

## 9.16.2 Aerogen Solo nebulizer

| Aerogen Solo nebulizer |   |
|------------------------|---|
| Weight                 | Approximate 13.5 g  |
| Dimensions             | W 48 x L 25 x H 67 mm   |
| Particle size, graph   | Representative particle size distribution for Salbutamol (Albuterol) as per EN 13544-1. |

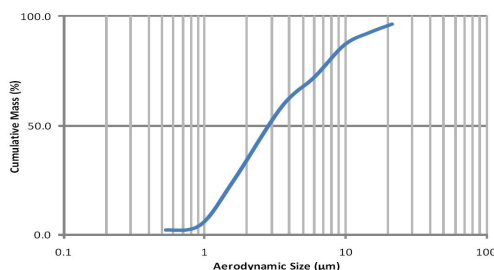

|   |           |
|---|-----------|
| As measured with the Anderson Cascade Impactor: |           |
| • Specification range                           | 1 - 5 µm. |
| • Average tested                                | 3.1 µm    |

|   |               |
|---|---------------|
| As measured with the Marple 298 Cascade Impactor: |               |
| • Specification range                             | 1.5 - 6.2 µm. |
| • Average tested                                  | 3.9 µm        |

|                            |   |
|----------------------------|---|
| Flow rate                  | >0.2 (average: ~0.38) ml/min  |
| Max volume, medication cup | 6 ml  |
| Residual volume            | <0.1 ml for 3 ml dose   |
| Control cable              | 1.8 m   |
| Aerosol output rate        | 0.30 ml/min with starting dose 2 ml   |
| Aerosol output             | 1.02 ml with starting dose 2 ml   |
| Medication temperature     | The temperature of the medication will not rise more than 10°C (18°F) above ambient temperature during normal use.  |
| Lifetime                   | <ul style="list-style-type: none"> <li>• Intermittent use a maximum of 28 days based on a typical usage profile of four treatments per day.</li> <li>• Continuous use a maximum of 7 days.</li> </ul> Do not exceed the recommended usage time. |

## 9.17 CO<sub>2</sub> analyzer

| General - CO <sub>2</sub> analyzer |   |
|------------------------------------|---|
| Standard compliance                | ISO 80601-2-55:2011   |
| Classification                     | Type BF according to IEC 60601-1.   |
| Measured parameters                | <ul style="list-style-type: none"> <li>• CO<sub>2</sub> End Tidal Concentration</li> <li>• CO<sub>2</sub> Minute Elimination</li> <li>• CO<sub>2</sub> Tidal Elimination</li> </ul> <p>The EndTidal CO<sub>2</sub> Concentration is measured as the maximum CO<sub>2</sub> concentration during the expiration.</p>   |
| Measuring method                   | Mainstream, dual-wavelength, non-dispersive infrared.   |
| Oxygen concentration compensation  | Automatic. Values supplied from the ventilator system   |
| Barometric pressure compensation   | Automatic. Values supplied from the ventilator system   |
| Measurement conditions             | <p>CO<sub>2</sub> minute elimination and CO<sub>2</sub> tidal elimination measurements are referenced to STPD (Standard Temperature Pressure Dry) at 0°C (standard temperature), standard pressure 1013 hPa and relative humidity 0 % (dry).</p> <p>Standard gas mixture of CO<sub>2</sub>, balance saturated air at 33°C, gas flow rate 2 l/min, halogenated hydrocarbons &lt;5 %.</p> |

| CAPNOSTAT 5 - CO <sub>2</sub> analyzer |   |
|--|---|
| Size                                   | <ul style="list-style-type: none"> <li>• CO<sub>2</sub> analyzer module: 154 x 90 x 43 mm</li> <li>• Sensor: 32.0 x 47.0 x 21.6 mm</li> </ul>   |
| Weight                                 | <ul style="list-style-type: none"> <li>• CO<sub>2</sub> analyzer module: 450 g</li> <li>• Sensor: 20 g</li> <li>• Airway adapter: 10 g</li> </ul>   |
| Sensor cable                           | 2.8 m   |
| Operating temperature                  | 10°C to 33°C  |
| Measuring range                        | <ul style="list-style-type: none"> <li>• 0 to 100 mmHg CO<sub>2</sub> partial pressure</li> <li>• 0 to 13.3 kPa CO<sub>2</sub> partial pressure</li> <li>• 0 to 13.2 % CO<sub>2</sub> volume (at a barometric pressure of 1013 hPa)</li> </ul>  |
| Stability (within 8-hour period)       | ±2 mmHg/±0.3 kPa/±0.3 % (at a barometric pressure of 1013 hPa)  |
| Inaccuracy                             | <p>The end-tidal CO<sub>2</sub> is calculated as the highest CO<sub>2</sub> reading measured during expiration.<sup>19</sup></p> <ul style="list-style-type: none"> <li>• ±(3.3 mmHg + 8 % of reading)</li> <li>• ±(0.44 kPa + 8 % of reading)</li> <li>• ±(0.43 % of total volume fraction + 8 % of reading)</li> </ul> <p>The inaccuracy of the end tidal CO<sub>2</sub> has been verified by a CO<sub>2</sub> reference gas that has been altered with air.<br/>Refer to section Standard condition specification on page 176.</p> |
| System response time CO <sub>2</sub>   | The total system response time of the CO <sub>2</sub> monitor when exposed first to air and then to a gas mix with 5.0 % CO <sub>2</sub> is <250 ms.  |
| Warm-up time                           | 15 s to initial CO <sub>2</sub> indication<br>maximum 2 minutes to full specification   |
| Digitizing rate                        | 100 Hz  |
| Airway adapter dead space              | <ul style="list-style-type: none"> <li>• Neonatal/Pediatric: &lt;1 cm<sup>3</sup></li> <li>• Adult: &lt;5 cm<sup>3</sup></li> </ul>   |

19. CO<sub>2</sub> accuracy may decrease for RR >40 b/min.

**CAPNOSTAT 3 - CO<sub>2</sub> analyzer**

|                                      |   |
|--------------------------------------|---|
| Size                                 | <ul style="list-style-type: none"> <li>• CO<sub>2</sub> analyzer module: 154 x 90 x 43 mm</li> <li>• Sensor: 32.0 x 42.4 x 21.6 mm</li> </ul>   |
| Weight                               | <ul style="list-style-type: none"> <li>• CO<sub>2</sub> analyzer module: 450 g</li> <li>• Sensor: 18 g</li> <li>• Airway adapter: 10 g</li> </ul>   |
| Sensor cable                         | 2.4 m   |
| Operating temperature                | 10°C to 37°C  |
| Measuring range                      | <ul style="list-style-type: none"> <li>• 0 to 100 mmHg CO<sub>2</sub> partial pressure</li> <li>• 0 to 13.3 kPa CO<sub>2</sub> partial pressure</li> <li>• 0 to 13.2 % CO<sub>2</sub> volume (at a barometric pressure of 1013 hPa)</li> </ul>  |
| Stability (within 8-hour period)     | ±2 mmHg/±0.3 kPa/±0.3 % (at a barometric pressure of 1013 hPa)  |
| Inaccuracy                           | <p>The end-tidal CO<sub>2</sub> is calculated as the highest CO<sub>2</sub> reading measured during expiration.<sup>20</sup></p> <ul style="list-style-type: none"> <li>• ±(3.3 mmHg + 8 % of reading)</li> <li>• ±(0.44 kPa + 8 % of reading)</li> <li>• ±(0.43 % of total volume fraction + 8 % of reading)</li> </ul> <p>The inaccuracy of the end tidal CO<sub>2</sub> has been verified by a CO<sub>2</sub> reference gas that has been altered with air. Refer to section Standard condition specification on page 176.</p> |
| System response time CO <sub>2</sub> | The total system response time of the CO <sub>2</sub> monitor when exposed first to air and then to a gas mix with 5.0 % CO <sub>2</sub> is <250 ms.  |
| Warm-up time                         | 30 s to initial CO <sub>2</sub> indication<br>maximum 5 minutes to full specification   |
| Digitizing rate                      | 87 Hz   |
| Airway adapter dead space            | <ul style="list-style-type: none"> <li>• Neonatal/Pediatric: &lt;1 cm<sup>3</sup></li> <li>• Adult: &lt;5 cm<sup>3</sup></li> </ul>   |

20. CO<sub>2</sub> accuracy may decrease for RR >40 b/min.

## 9.18 Y sensor

| Y sensor                  |  |
|---------------------------|--|
| Size                      | <ul style="list-style-type: none"> <li>• Y sensor module: W 154 x L 90 x H 21 mm</li> <li>• Y sensor: W 18 x L 50 x H 27 mm</li> </ul>   |
| Weight                    | <ul style="list-style-type: none"> <li>• Y sensor module: 280 g</li> <li>• Y sensor: 11 g</li> </ul>   |
| Connectors and cables     | <ul style="list-style-type: none"> <li>• 15 mm male and female conical connector on flow sensor according to ISO 5356-1</li> <li>• Pressure port on module<br/>Pressure line, 2.0 m, phthalate free PVC</li> <li>• Flow sensor cable, 2.0 m</li> </ul> |
| Y sensor material         | <ul style="list-style-type: none"> <li>• Single use: PC, Polycarbonate</li> <li>• Reusable: PEI, Polyetherimide or PSF, Polysulfone</li> </ul>   |
| Power source              | Powered from the ventilator system   |
| Power consumption         | ≤ 4.5 W, during normal operation   |
| Y sensor measuring method | Hot Wire Anemometer (HWA)  |
| Parameters                | <ul style="list-style-type: none"> <li>• Airway flow</li> <li>• Airway pressure</li> <li>• Inspiratory volume</li> <li>• Expiratory volume</li> <li>• Trigger</li> <li>• End inspiration</li> </ul>  |
| Measuring range           | <ul style="list-style-type: none"> <li>• Flow: 0.12 to 32 l/min</li> <li>• Pressure: -40 to 120 cmH<sub>2</sub>O</li> </ul>  |
| Y sensor resistance       | 10 cmH <sub>2</sub> O/l/s at 30 l/min  |
| Dead space                | ≤ 1 ml   |
| Pressure line connector   | Gable mounted bulk head connector to fit tubings with an inner diameter of 3-4 mm  |

## 9.19 Communication/interface

| Communication/interface             |   |
|-------------------------------------|---|
| Serial ports                        | Isolated<br>RS-232C. For data communication via the Servo Communication Interface (SCI)<br>Information regarding connector wiring is available from Maquet.   |
| Servo Communication Interface (SCI) | A protocol for data communication with external devices   |
| Alarm output connection             | Isolated<br>4-pin modular connector for communication of all active alarms<br>Switching capability: Max 40V DC, Max 500 mA, Max 20 W<br>Information regarding connector wiring is available from Maquet.                                      |
| Data Transfer via USB port          | Non-isolated<br>For transfer of trends, logs, screen shots and recordings to a USB memory stick   |
| VGA port                            | Non-isolated<br>External monitors should be isolated from the ventilator system. This can be achieved if the connected monitor is powered via a medical grade transformer.<br>The secondary monitor output is not to be relied on for alarms. |
| Ethernet port                       | Isolated<br>The network connection (LAN) port is for service use, and should only be used by personnel trained and authorized by Maquet.  |

Connection of the ventilator system to other equipment through the communication interfaces, forming a medical electrical system, could result in previously unidentified risks to patient, users or third parties.

The responsible organization should identify, analyze, evaluate and control these risks.

Subsequent changes to the medical electrical system could introduce new risks and require additional analysis.

Changes to the medical electrical system include configuration changes, connection of additional items, disconnection of items, update or upgrade of connected equipment.



## 9.20 Accessories

| Mobile cart (option)   |  |
|--|--|
| Weight   | 13.0 kg  |
| Dimensions   | W 647 x L 547 x H 557 mm   |
| Preventive maintenance interval  | 5000 running hours   |
| Humidifier holder (option)   |  |
| Weight   | 0.5 kg   |
| Dimensions   | W 243 x L 38 x H 185   |
| Maximum load   | 5 kg   |
| Support arm 178 (option)   |  |
| Weight   | 2.5 kg   |
| Dimensions   |  |
| Dimensions   | Length 900 mm  |
| Maximum load   | <ul style="list-style-type: none"> <li>• 1 kg at 180°</li> <li>• 1.5 kg at 90°</li> <li>• 3 kg at 45°</li> </ul> Refer to Support arm 178 Installation Instructions. |
| <b>Note:</b> When the knob on the support arm is loosened it also releases the lock to the column. |  |
| Water bag/IV pole (option)   |  |
| Weight   | 0.4 kg   |
| Dimensions   | W 148 x L 26 x H 1007  |
| Maximum load   | 1.5 kg   |
| Drawer (option)  |  |
| Weight   | 0.6 kg   |
| Dimensions   | W 247 x L 118 x H 302  |
| Gas cylinder restrainer kit (option)   |  |
| Make sure that the gas cylinder restrainer straps are placed on the middle of the gas cylinders.   |  |
| Weight   | 0.5 kg   |
| Dimensions   | Upper: W 104 x L 65 x H 48<br>Lower: W 106 x L 162 x H 76  |
| Maximum load   | Two 4.5-liter bottles  |
| Pendant/bed holder (option)  |  |
| Weight   | 3.2 kg   |

**Pendant/bed holder (option)**

|            |                       |
|------------|-----------------------|
| Dimensions | W 302 x L 302 x H 393 |
|------------|-----------------------|

**Shelf base (option)**

Make sure that the shelf base is securely fixed on the table or shelf.

|        |        |
|--------|--------|
| Weight | 2.5 kg |
|--------|--------|

|            |                      |
|------------|----------------------|
| Dimensions | W 207 x L 302 x H 43 |
|------------|----------------------|

**Y piece holder (option)**

|            |                    |
|------------|--------------------|
| Dimensions | W 26 x L 52 x H 46 |
|------------|--------------------|

**User interface holder (option)**

|        |        |
|--------|--------|
| Weight | 0.6 kg |
|--------|--------|

|            |                     |
|------------|---------------------|
| Dimensions | W 46 x L 90 x H 123 |
|------------|---------------------|

**Cable holder for handle (option)**

|        |        |
|--------|--------|
| Weight | 0.1 kg |
|--------|--------|

|            |                      |
|------------|----------------------|
| Dimensions | W 138 x L 92 x H 155 |
|------------|----------------------|

|              |      |
|--------------|------|
| Maximum load | 5 kg |
|--------------|------|

**Other accessories (option)**

|                 |   |
|-----------------|---|
| Compressor Mini | Refer to the Compressor Mini User's Manual. |
|-----------------|---|

|                                    |  |
|------------------------------------|--|
| Expiratory heater, Servo Duo Guard | Refer to the Expiratory heater, Servo Duo Guard User's Manual. |
|------------------------------------|--|

|                 |   |
|-----------------|---|
| Servo Duo Guard | Refer to the Servo Duo Guard User's Manual. |
|-----------------|---|

|             |   |
|-------------|---|
| Servo Guard | Refer to the Servo Guard User's Manual. |
|-------------|---|

## 9.21 Health and Environment

### 9.21.1 Pollution control

This product complies with environmental protection use period as defined in People's Republic of China Electronic Industry Standard SJ/T11364-2014.



Toxic or hazardous substances will not leak or mutate under normal operating conditions for 50 years.

### 9.21.2 Hazardous substances

The following table shows the names and contents of toxic or hazardous substances in this product as defined in People's Republic of China Electronic Industry Standard SJ/T11364-2014.

| Parts                       | Hazardous substances |    |    |                  |     |      |
|-----------------------------|----------------------|----|----|------------------|-----|------|
|                             | Pb                   | Hg | Cd | Cr <sup>6+</sup> | PBB | PBDE |
| Metal parts                 | 0                    | 0  | 0  | 0                | 0   | 0    |
| Plastic and polymeric parts | 0                    | 0  | 0  | 0                | 0   | 0    |
| Electrical components       | 0                    | 0  | 0  | 0                | 0   | 0    |
| LCD display                 | 0                    | 0  | 0  | 0                | 0   | 0    |

0: Indicates that this toxic or hazardous substance contained in all of the homogeneous materials for this part is below the limit and meets the requirement in GB/T 26572-2011.

X: Indicates that this toxic or hazardous substance contained in at least one of the homogeneous materials used for this part is above the limit requirement in GB/T 26572-2011.

## 9.22 UDI Label

| UDI Label                           |   |
|-------------------------------------|---|
| Unique Device Identification number | Global standard for identifying Medical Equipment, example:<br>(01)07325710000007(11)140625(21)01311141   |
| Application Identifier (AI)         | Each UDI number can be divided into several parts, each referred to by their AI number '#'.<br>(01) GTIN - Global Trade Item Number<br>(241) Part number<br>(10) Batch no.<br>(11) Manufacturing date (YYMMDD)<br>(17) Exp. date (YYMMDD)<br>(20) Revision<br>(21) Serial number<br>(30) Count of items |
| The GTIN consists of four parts:    | 0 732571 000021 2   |
| a. Package level                    | a      b      c      d  |
| b. GS-1 company prefix              |   |
| c. Item reference                   |   |
| d. Check digit                      |   |

## 9.23 Information required by ISO 80601-2-12

### 9.23.1 Volume-controlled breath type

#### Volume-controlled breath type

Characteristics valid for patient categories and circuit configurations intended to provide the indicated tidal volume, at conditions specified in ISO 80601-2-12, table 201.103.

Maximum inaccuracy of inspired tidal volume (VT)

- Neonatal:  $\pm(1 \text{ ml} + 7 \% \text{ of set volume})$  for  $VT \leq 50 \text{ ml}$
- Pediatric:  $\pm(4 \text{ ml} + 7 \% \text{ of set volume})$  for  $50 \text{ ml} \leq VT \leq 300 \text{ ml}$
- Adult:  $\pm(4 \text{ ml} + 7 \% \text{ of set volume})$  for  $VT \geq 300 \text{ ml}$

Maximum inaccuracy of PEEP

- Neonatal:  $\pm(1 \text{ cmH}_2\text{O} + 5 \% \text{ of set value})$  for  $20 < VT \leq 50 \text{ ml}$   
 $\pm(1.5 \text{ cmH}_2\text{O} + 5 \% \text{ of set value})$  for  $VT \leq 20 \text{ ml}$
- Pediatric:  $\pm(1 \text{ cmH}_2\text{O} + 5 \% \text{ of set value})$  for  $50 \text{ ml} \leq VT \leq 300 \text{ ml}$
- Adult:  $\pm(1 \text{ cmH}_2\text{O} + 5 \% \text{ of set value})$  for  $VT \geq 300 \text{ ml}$

Maximum inaccuracy of inspired oxygen concentration ( $\text{FiO}_2$ ) at the patient connection port  $\pm(3 \% + 0 \% \text{ of set value})$

### 9.23.2 Pressure-controlled breath type

#### Pressure-controlled breath type

Characteristics valid for patient categories and circuit configurations intended to provide the indicated tidal volume, at conditions specified in ISO 80601-2-12, table 201.104.

Maximum inaccuracy of airway pressure ( $P_{AW}$ ) at the end of the inspiratory phase  $\pm(1 \text{ cmH}_2\text{O} + 7 \% \text{ of set value})$

Maximum inaccuracy of PEEP  $\pm(1 \text{ cmH}_2\text{O} + 5 \% \text{ of set value})$

Maximum inaccuracy of inspired oxygen concentration ( $\text{FiO}_2$ ) at the patient connection port  $\pm(3 \% + 0 \% \text{ of set value})$

### 9.23.3 O<sub>2</sub> concentration response time

Characteristics valid at conditions specified in ISO 80601-2-12, table 201.105.

#### Response time for oxygen concentration to change from 21 % to 90 %

- Maximum 30 s at  $VT = 500 \text{ ml}$ , for patient categories and circuit configurations intended to provide  $VT \geq 300 \text{ ml}$
- Maximum 35 s at  $VT = 150 \text{ ml}$ , for patient categories and circuit configurations intended to provide  $50 \text{ ml} \leq VT \leq 300 \text{ ml}$
- Maximum 55 s at  $VT = 30 \text{ ml}$ , for patient categories and circuit configurations intended to provide  $VT \leq 50 \text{ ml}$

## 9.24 Technical description

The technical description is intended for the responsible organization and service personnel.

| Topic   | Information   |
|---|---|
| Filtering   | Refer to section Monitoring on page 181.  |
| Detachable parts  | Refer to section Gas flow through the Patient unit on page 22.  |
| Start and end the inspiratory phase   | Refer to chapter Ventilation modes and therapies on page 63.  |
| Automatic check of alarm system.  | Refer to section Pre-use check on page 38.  |
| Measurement uncertainty for disclosed tolerances  | Refer to sections Inspiratory channel on page 179, Expiratory channel on page 180 and Monitoring on page 181.                                   |
| Safe operation  | Refer to section Safety guidelines on page 8.   |
| Transport and storage   | Refer to section Transport on page 35.  |
| Measures or conditions for installing the ventilator system.  | Information regarding installation is available from Maquet.  |
| Operation overview  | Refer to chapter Operation overview on page 37.   |
| Safety signs and symbols <ul style="list-style-type: none"> <li>• Marking on equipment</li> <li>• Consult accompanying documents</li> <li>• Mechanical stability</li> <li>• Protective packaging</li> </ul> | Refer to sections Symbols on patient unit on page 20, Symbols on User Interface on page 31 and Symbols on accessories and packaging on page 33. |
| Identification of the ventilator system and software version  | Refer to sections SERVO-U Ventilator System v2.1 on page 1 and Version and Configurations on page 13.   |
| Power sources   | Refer to section System on page 172.  |
| IP classification   | Refer to section System on page 172.  |
| Applied part — type of classification   | Refer to sections Symbols on accessories and packaging on page 33 and System on page 172.   |
| Mode of operation   | Refer to section System on page 172.  |
| Fuses   | Refer to sections Operation overview on page 37 and System on page 172.   |
| External pressure source  | Refer to section Ventilator system on page 175.   |
| Modification of the ventilator system   | Do not modify or remove any original parts.   |

| Topic   | Information  |
|---|--|
| Service and installation <ul style="list-style-type: none"> <li>• Qualifications for service personnel</li> <li>• Replacement of parts</li> <li>• Installation requirements</li> <li>• Documentation</li> </ul> | Refer to section Service on page 197.  |
| Isolate from mains power  | Isolate the ventilator system from mains power by disconnecting the mains power cable from the outlet. |
| Alarms preset   | Refer to section Alarms on page 168 and section Turning off alarms on page 151.                        |
| Technical data  | Refer to chapter Technical data on page 171.   |
| System overview   | Refer to chapter System Overview on page 15.   |





## 10 Index

- A**
- Accessories
- cable holder for handle 206
  - drawer 205
  - expiratory heater, Servo Duo Guard 206
  - gas cylinder restrainer kit 205
  - humidifier holder 205
  - mobile cart 205
  - pendant/bed holder 206
  - Servo Duo Guard 206
  - Servo Guard 206
  - shelf base 206
  - support arm 205
  - water bag/IV pole 205
  - Y piece holder 206
- Aerogen nebulizer unit 129, 134, 134
- Aerogen nebulizers
- adding medication 132
  - assemble 130
  - function test 132
- Aerogen Pro nebulizer
- aerosol output 198
  - aerosol output rate 198, 199
  - control cable 198
  - dimensions 198
  - flow rate 198
  - lifetime 199
  - medication cup 199
  - medication temperature 199
  - particle size 199
  - residual volume 199
  - specification range 199, 199
- Aerogen Solo nebulizer
- aerosol output 199
  - average tested 198, 198, 199, 199
  - continuous nebulization 134
  - control cable 199
  - dimensions 199
  - flow rate 199
  - lifetime 199
  - medication cup 199
  - medication temperature 199
  - particle size 199
  - residual volume 199
  - specification range 199, 199
  - weight 198, 199
- Aerosol output
- Aerogen Pro nebulizer 198, 198, 199
  - Aerogen Solo nebulizer 199
- Airway adapter dead space
- CO2 analyzer 201, 202
- Airway pressure 182
- Alarm limits
- default values 191
  - parameters 191
  - setting range 191
- Alarm output connection 14, 20, 162, 184, 204
- Alarm state test 184
- Alarms
- default settings 146
  - handling 147
  - high priority 154, 154, 161
  - indication 147
  - low priority 160, 161
  - medium priority 156, 161
  - sound level 44
  - turn off 152, 152
- Ambient pressure 176
- Apnea
- audio delay 127
  - management 126
  - maximal time 115
  - time 115, 126
- Atmospheric pressure 173, 173
- Audio off 191
- Automode 90
- Average tested
- Aerogen Pro nebulizer 198, 198
  - Aerogen Solo nebulizer 199, 199

- B**
- Backup ventilation
  - deactivating 128
  - trends 127
- Barometer test 183
- Barometric pressure compensation
  - CO2 analyzer 200
  - monitoring 182
- Battery
  - backup 174
  - disposal 174
  - lifetime 174
  - warnings 11
- Battery switch test 184
- Bias flow during expiration 180
- Biomed 164
- Bi-Vent/APRV 73
- Body weight 116
- Breathing parameters
  - default values 185, 188
  - parameters 188
  - setting range 188
- BTPS 176
- BW 116
  
- C**
- Cable holder for handle
  - dimensions 206
  - maximum load 206
  - weight 206
- Calibration
  - CO2 analyzer 40, 137, 139, 139
  - Y sensor 40, 142
- Cautions
  - general 9
  - power supply 11
- Classification
  - CO2 analyzer 200
- CO2
  - monitoring 135
- CO2 analyzer
  - airway adapter dead space 201, 202
  - barometric pressure compensation 200
  - calibration 40, 137, 139, 139
  - classification 200
  - components 136
  - digitizing rate 201, 202
  - full calibration 139
  - inaccuracy 201, 202
  - measured parameters 200
  - measurement conditions 200
  - oxygen concentration compensation 200
  - standard compliance 200, 201, 202
  - system response time 201, 202
  - use guidelines 136
  - warm-up time 201, 202
  - weight 201, 202
  - zero offset adjustment 139
- CO2 monitoring 135, 135
- Communication/Interface
  - alarm output connection 204
  - ethernet port 204
  - SCI 204
  - serial ports 204
  - USB port 204
  - VGA port 204
- Compensation
  - circuit 120, 176
  - leakage 119
- Compliance 178
- Compressor Mini 206
- Configuration
  - Biomed code 169
  - set date 169
  - set time 169
  - view 60
- Conical fittings 175
- Connection standards 175
- Connectors and cables
  - Y sensor 203
- Continuous nebulization 134
- Control cable
  - Aerogen Pro nebulizer 198
  - Aerogen Solo nebulizer 199

user interface 17

## D

Dead space

Y sensor 203

Decelerating flow 70

Default alarm settings 146

Digitizing rate

CO2 analyzer 201, 202

Dimensions

cable holder for handle 206

drawer 205

gas cylinder restrainer kit 205

humidifier holder 205

mobile cart 205

pendant/bed holder 206

shelf base 206

support arm 205

user interface adapter 206

ventilator 175, 205

water bag/IV pole 205

Y piece holder 206

Disconnection/Suction 122

Drawer

dimensions 205

weight 205

Driving pressure 116

## E

Edi

cable 194

catheters 84, 85, 85, 194

module 194, 194

monitoring 121

Edi module

function check 40

EMC 172

End inspiration 110

Essential performance 177

Expiratory

flow measurements 180

heater, Servo Duo Guard 206

hold 118

minute volume 182

tidal volume 181

Expiratory channel

airway pressure 182

barometric pressure compensation 182

bias flow during expiration 180

expiratory flow measurements 180

filtering 183

internal compressible factor 180

O2 concentration 182

PEEP regulation 180

PEEP setting range 180

pressure drop 180

respiratory rate 182

supply pressure 182

system response time O2 182

Export & delete 59, 178

## F

Filtering 183

Flow adaptation 70

Flow rate

Aerogen Pro nebulizer 198

Aerogen Solo nebulizer 199

Flow transducer test 184

Functions

circuit compensation 120

disconnection/suction 122

Edi monitoring 121

leakage compensation 119

manual breath 117

max. inspiration time 193

nebulization 118

NIV disconnection flow 193

O2 boost level 118

static measurements 117

## G

Gas

delivery device 179

delivery system 179

- exhaust port 175
- Gas cylinder restrainer kit
  - dimensions 205
  - maximum load 205
  - weight 205
- Gas flow 22
- Gas quality 175
- Gas supply
  - connection standards 175
  - gas quality 175
  - inlet gas 175
  - max. levels 175
  - test 183
- General
  - caution 9
  - important 10
  - note 10
  - warning 8

## H

- Height
  - units 166
- High Flow therapy 49, 50, 104
- High priority alarms 154, 161
- Holders
  - cable holder for handle 206
  - gas cylinder restrainer kit 205
  - humidifier holder 205
  - pendant/bed holder 206
  - shelf base 206
  - support arm 205
  - water bag/IV pole 205
  - Y piece 206

- Humidifier
  - holder
    - dimensions 205

## I

- I:E ratio 109, 176
- Important
  - general 10
- Important settings 108

- Inaccuracy
  - CO2 analyzer 201, 202
- Ingress protection 173
- Inlet
  - gas 175
  - pressure 176
- Inspiration time 110
- Inspiratory
  - hold 118
  - minute volume 180
  - resistance 178
  - rise time 111
  - tidal volume 179, 181
- Inspiratory channel
  - gas delivery device 179
  - gas delivery system 179
  - inspiratory minute volume 180
  - inspiratory tidal volume 179
  - internal compressible factor 179
  - max. airway pressure 179
  - NIV max leakage compensation level 179
  - O2 concentration 179
  - pressure drop 179
- Intended use 6
- Internal
  - compressible factor 179, 180
  - leakage test 183
  - test 183

## L

- Leakage 176
- Lifetime
  - Aerogen Pro nebulizer 198
  - Aerogen Solo nebulizer 199

- Logs
  - event log 196, 196
- Low priority alarms 160, 161
- Lowest pressure in patient circuit 173

## M

- Maneuvers
  - manual breath 117

- static measurements 117
- Material
  - Y sensor 203
- Maximum
  - airway pressure 179
  - gas levels 175
  - inspiration time 193
- Maximum load
  - cable holder for handle 206
  - gas cylinder restrainer kit 205
  - humidifier holder 205
  - support arm 205
  - water bag/IV pole 205
- Measured parameters
  - CO2 analyzer 200
- Measurement conditions
  - CO2 analyzer 200
- Measuring method
  - Y sensor 203
- Measuring range
  - Y sensor 203
- Media
  - recording waveforms 58
  - saving screenshots 58
- Medication cup
  - Aerogen Pro nebulizer 198
  - Aerogen Solo nebulizer 199
- Medication temperature
  - Aerogen Pro nebulizer 198
  - Aerogen Solo nebulizer 199
- Medium priority alarms 156, 161
- Minute volume 108
- Mobile cart
  - dimensions 205
  - preventive maintenance interval 205
  - weight 205
- Modes
  - Automode 90
  - Bi-Vent/APRV 73
  - NAVA 81, 89
  - Pressure Control 65
  - Pressure Regulated Volume Control 67
  - Pressure Support/CPAP 75
  - SIMV 93
  - Volume Control 69
  - Volume Support 78
- Module
  - handling 19
- Monitoring
  - expiratory minute volume 182
  - expiratory tidal volume 181
  - inspiratory tidal volume 181
- N**
- Nasal CPAP 102
- NAVA
  - level 115
  - workflow 83
- Nebulization 129, 133, 134
- Nebulization
  - continuous 134
  - on/off 133
- Nebulizer
  - Pro 129, 134
  - Solo 129, 134
  - use guidelines 130, 130
- NIV
  - Pressure Control 99
  - Pressure Support 100
- NIV disconnection flow 193
- NIV disconnection function
  - edit 167
- NIV max leakage compensation level 179
- NIV NAVA 101
- Noise 173
- Non invasive ventilation 96
- Non operating conditions
  - atmospheric pressure 173
  - relative humidity 173
  - temperature 173
- Notes
  - general 10
  - power supply 11
- Numerical values 53

## O

### O2

- boost function 119
- cell adjustment 143
- concentration 179

### O2 boost level 118

### O2 cell adjustment 143

### O2 cell/sensor test 184

### O2 concentration 108, 182

### Operating conditions

- atmospheric pressure 173
- lowest pressure in patient circuit 173
- relative humidity 173
- temperature range 173

### Oxygen concentration compensation

- CO2 analyzer 200

## P

### Parameters

- Y sensor 203

### Particle size

- Aerogen Pro nebulizer 198
- Aerogen Solo nebulizer 199

### Patient category 41, 41, 172

### Patient category

- change 41
- select 41
- set 41, 41

### Patient circuit 23

### Patient circuit

- 10 mm dual heat 26
- 10 mm single heat 25
- 15-22 mm single heat 23
- 22 mm dual heat 24

### Patient circuit test 40, 184

### Patient circuit test

- compliance 178
- expiratory resistance 178
- inspiratory resistance 178

### Patient data

- deleting 59
- enter 30

### exporting 59

### Patient system connectors

- conical fittings 175
- gas exhaust port 175
- pressure line connector 175

### Patient unit 18

### Patient unit

- on/off switch 19
- serial number 19

### PBW 116

### Pdrive 116

### PEEP regulation 180

### PEEP setting range 180

### Pendant/bed holder

- dimensions 206
- weight 205

### Power consumption

- Y sensor 203

### Power supply

- cautions 11
- external 12V DC 174
- notes 11
- range 174
- warnings 11
- Y sensor 203

### Predicted body weight 116

### Pressure Control 65

### Pressure drop 179, 180

### Pressure level 108

### Pressure line connector 175

### Pressure line connector

- Y sensor 203

### Pressure Regulated Volume Control 67

### Pressure Support/CPAP 75

### Pressure transducer test 183

### Pre-use check 38, 39, 176, 183

### Pre-use check

- start 39

### Pre-use check test

- alarm output connection 14, 20, 184
- alarm state test 184
- barometer test 183

- battery switch test 184
- flow transducer test 184
- gas supply test 183
- internal leakage test 183
- internal test 183
- O2 cell test 184
- patient circuit test 184
- pressure transducer test 183
- safety valve test 184
- Y sensor calibration 184
- Preventive maintenance interval
  - mobile cart 205
- Previous mode 125
- R**
- Relative humidity 173, 173
- Remote Services 170
- Residual volume
  - Aerogen Pro nebulizer 198
  - Aerogen Solo nebulizer 199
- Resistance
  - Y sensor 203
- Respiratory rate 182
- Room temperature 176
- S**
- Safety scales 29, 42
- Safety valve test 184
- Select
  - ventilation 42
- Service 169, 197
- SERVO COMPASS 54
- Servo Duo Guard 206
- Servo Guard 206
- Set
  - alarm limits 43
  - patient category 41, 41
- Settings 176
- Settings
  - apnea time 115
  - end inspiration 110
  - I:E ratio 109
  - inspiratory rise time 111
  - minute volume 108
  - NAVA level 115
  - O2 concentration 108
  - pressure level 108
  - settings-related information 116
  - SIMV breath cycle time 116
  - tidal volume 108
  - trigger 112
- Shelf base
  - dimensions 206
  - weight 206
- Shortcuts 30
- SIMV breath cycle time 116
- Size
  - CO2 analyzer 201, 202
  - Y sensor 203
- Specification range
  - Aerogen Pro nebulizer 198, 198
  - Aerogen Solo nebulizer 199, 199
- Standard conditions
  - ambient pressure 176
  - BTPS 176
  - circuit compensation 176
  - I:E 176
  - inlet pressure 176
  - pre-use check 176
  - room temperature 176
  - settings 176
  - STPD 176
  - ventilatory frequency 176
- Standards
  - CO2 analyzer 200
  - Ventilator 172
- Start
  - pre-use check 39
  - ventilation 45
- Startup configuration 166
- Stop
  - ventilation 45
- Storage temperature 173
- STPD 176

Suction  
    closed suctioning 124  
    open suctioning 123

Supply pressure 182

Support arm  
    dimensions 205  
    maximum load 205  
    weight 205

Symbols  
    accessories and packaging 33  
    patient unit 20  
    user interface 31

System  
    EMC 172  
    ingress protection 173  
    noise 173

System response time O2 182, 201, 202

System status 60

## T

Technical alarms  
    high priority alarms 154  
    low priority alarms 160, 161  
    medium priority alarms 156, 161

Technical error messages 161

Temperature range 173

Temporary O2 increase  
    edit 167

Tidal volume 108

Transport 35

Transport  
    before transport 35  
    during transport 35

Trends 56, 195

Triggering  
    Edi trigger 114  
    pneumatic trigger 112

## U

Units  
    height 166  
    weight 166

User interface 27

User interface  
    interactive areas 28  
    light frame 27  
    navigating 28  
    symbols 31  
    USB port 27

User interface adapter  
    dimensions 206  
    weight 206

## V

Ventilation  
    select 41, 42  
    start 45  
    stop 45

Ventilator 16

Ventilator  
    configuration 60  
    dimensions 175, 205  
    weight 175

Ventilatory frequency 176

Ventilatory settings 185

Views  
    Advanced 49, 55  
    Basic 48  
    Distance 51, 56  
    Family 51  
    Loops 50, 55  
    SERVO COMPASS 54

Volume Control 69

Volume Support 78

VT/BW 116

VT/PBW 116

## W

Warm-up time  
    CO2 analyzer 201, 202

Warnings  
    battery 11  
    fire hazard 12  
    general 8



- power supply 11
  - Water bag/IV pole
    - dimensions 205
    - maximum load 205
    - weight 205
  - Waveform
    - estimated pressure 53
  - Waveforms
    - displaying 52
    - scaling 52
  - Weight
    - Aerogen Pro nebulizer 198, 198
    - Aerogen Solo nebulizer 199, 199
    - cable holder for handle 206
    - CO2 analyzer 201, 202
    - drawer 205
    - gas cylinder restrainer kit 205
    - humidifier holder 205
    - mobile cart 205
    - pendant/bed holder 205
    - shelf base 206
    - support arm 205
    - units 166
    - user interface adapter 206
    - ventilator 175
    - water bag/IV pole 205
    - Y sensor 203
  - pressure line connector 203
  - resistance 203
  - size 203
  - test 184
  - use guidelines 141
  - weight 203
- Y**
- Y piece holder
    - dimensions 206
  - Y sensor
    - calibration 40, 142
    - components 141
    - connectors and cables 203
    - dead space 203
    - material 203
    - measuring method 203
    - measuring range 203
    - parameters 203
    - power consumption 203
    - power supply 203





---

**MAQUET**  
GETINGE GROUP

Manufacturer: Maquet Critical Care AB  
Röntgenvägen 2  
171 54 Solna, Sweden  
Phone: +46 (0) 10 335 73 00  
[www.maquet.com](http://www.maquet.com)

For local contact:  
Please visit our website  
[www.maquet.com](http://www.maquet.com)



---

**GETINGE GROUP**

Getinge Group is a leading global provider of products and systems that contribute to quality enhancement and cost efficiency within healthcare and life sciences. We operate under the three brands of ArjoHuntleigh, Getinge and Maquet. ArjoHuntleigh focuses on patient mobility and wound management solutions. Getinge provides solutions for infection control within healthcare and contamination prevention within life sciences. Maquet specializes in solutions, therapies and products for surgical interventions, interventional cardiology and intensive care.

SERVO-U Ventilator System v2.1

User's Manual