

User's Manual

SERVO-i VENTILATOR SYSTEM V7.1

MAQUET
GETINGE GROUP



TABLE OF CONTENTS

1	Introduction		5
2	System Overview		17
3	Power supply		35
4	Operation overview		41
5	Monitor and record		63
6	Ventilation, modes and functions		75
7	NAVA		151
8	Alarms		171
9	Optional Accessories		181
10	System messages		201
11	Start-up configuration		213
12	Technical data		217
13	Definitions		249
14	Appendix • User interface		253
15	Certificates		265
16	Index		267

1 INTRODUCTION

TABLE OF CONTENTS

1.1	Device description		6
1.2	Warning, Caution, Important and Note		9
1.3	Version and Configurations		14

1.1 DEVICE DESCRIPTION

This section provides general information about the SERVO-i Ventilator System along with guidelines for appropriate use.

1.1.1 DEVICE DIAGRAM

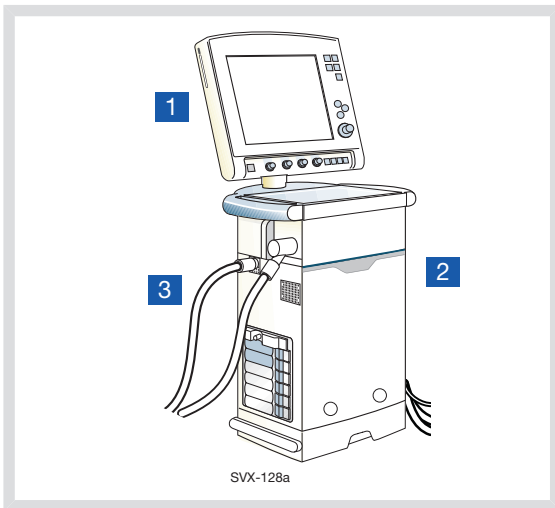

1.1.2 DEVICE COMPONENTS

The SERVO-i Ventilator System consists of the following components:

1. User Interface—for setting ventilation modes, displaying patient data, and indicating alarms
2. Patient Unit—for mixing gases
3. Patient Breathing System—for delivering and exchanging gases

1.1.3 INTENDED USE

The SERVO-i Ventilator System is intended for treating and monitoring patients ranging from neonates to adults with respiratory failure or respiratory insufficiency.

NAVA

The added indications for use of the NAVA or NIV NAVA software are that the electrical signal from the brain to the diaphragm is intact, and that there is no contraindication for insertion/exchange of nasogastric tube.

1.1.4 INTENDED USER

The SERVO-i Ventilator System should be used only by those who:

- are professional healthcare providers, and
- have received training in the use of this system, and
- have experience with ventilation treatment.

1.1.5 INTENDED USE ENVIRONMENT

The SERVO-i Ventilator System should be used only:

- in hospitals
- in facilities whose primary purpose is to provide healthcare
- during transport of a patient within hospitals or healthcare facilities
- during MR examinations of patients if the conditions in the SERVO-i MR Environment declaration (order no. 66 71 670) are met and an agreement with MAQUET is signed.

1.1.6 CLEANING AND MAINTENANCE

Please refer to the SERVO-i/s Cleaning and Maintenance User's Manual.

1.1.7 SERVICING GUIDELINES

CAUTIONS:

- **Regular Service:** The SERVO-i Ventilator System must be serviced at regular intervals by MAQUET authorized personnel who have received specialized training.
- **Complete Service Records:** All service performed on the SERVO-i Ventilator System must be recorded in a service log in accordance with hospital procedures and local and national regulations.
- **Service Contract:** We strongly recommend that all service on the SERVO-i Ventilator System should be performed as part of a service contract with MAQUET.

1.1.8 DISCLAIMERS

- **Improper Use Environment**
MAQUET has no responsibility for the safe operation of SERVO-i Ventilator System if the *Intended Use Environment* requirements specified in this document are not followed.
- **Nonprofessional Servicing**
MAQUET has no responsibility for the safe operation of the SERVO-i Ventilator System if installation, service or repairs are performed by persons other than MAQUET authorized personnel.

1.2 WARNING, CAUTION, IMPORTANT AND NOTE

Follow these safety guidelines. Additional warnings appear in context throughout this document.

Information is highlighted with Warning, Caution, Important or Note, where:

WARNING! Indicates critical information about a potential serious outcome to the patient or the user.

CAUTION: Indicates instructions that must be followed in order to ensure the proper operation of the equipment.

Important: Indicates information intended to help you operate the equipment or its connected devices easily and conveniently.

Note: Indicates information requiring special attention.

1.2.1 GENERAL

This manual summarizes the functions and safety features of the SERVO-i Ventilator System. It is not all-inclusive and should not be construed as a substitute for training.

WARNINGS!

- Always perform a Pre-use check before connecting the ventilator to a patient.
- If any of the following occurs, discontinue use of the ventilator and contact a service technician:
 - Unfamiliar pop-up windows on the screen
 - Unresolvable alarms
 - Unfamiliar sounds
 - Any unfamiliar or unexplained event
- Keep the ventilator upright during use.
- Make sure that ventilation is started when a patient is connected to the ventilator. When the ventilator is in Standby, a flashing message, *Patient not ventilated*, is displayed as a reminder directly above the word Standby.
- When the ventilator is connected to a patient:
 - Do not lift or disconnect the expiratory cassette.
 - Continuously monitor the settings and measurements displayed on the screen.
 - Make sure a resuscitator is readily available.
- The SERVO-i Ventilator System must be operated only by authorized personnel who are well trained in its use. It must be operated according to the instructions in this User's Manual.

- Do not modify or remove any original parts.
- Do not cover the ventilator in any way, since the functioning of the equipment may be adversely affected.
- When the ventilator is used for MCare Remote Service, use only network equipment that is safe and in compliance with the relevant electrical and EMC standards such as IEC-60950.

Note: The network cable is excluded from this requirement.

- Always disconnect the network cable before starting ventilation when the ventilator is used for MCare Remote Service.
- Positive pressure ventilation can be associated with the following adverse events: barotrauma, hypoventilation, hyperventilation or circulatory impairment.
- The SERVO-i Ventilator System should not be used in MR environments unless the requirements described in the SERVO-i MR Environment Declaration (order no. 66 71 670) are met and an agreement with MAQUET is signed.
- The SERVO-i Ventilator System is not intended to be used during radiotherapy, since this may cause system malfunction.
- The SERVO-i Ventilator System must not be used in a hyperbaric chamber unless it is equipped for hyperbaric oxygenation.
- The SERVO-i Ventilator System must not be used with helium without the Heliox option.

- Only accessories, supplies, and auxiliary equipment recommended by MAQUET should be used with the ventilator system. Use of any other accessories, spare parts or auxiliary equipment may cause degraded system performance and safety.
- The power supply cord must be plugged directly into the mains power outlet without the use of any multiple socket outlets. If a multiple socket outlet is used together with other products, total leakage current might be exceeded at earth fault.

CAUTIONS:

- In USA, Federal law restricts this device to sale by or on the order of a physician.
- The expiratory channel and expired gas from the exhaust port may be contaminated.
- Refer to the Installation instructions to assemble the system or options to obtain a proper mechanical assembly.
- Service, repair and installation must be performed by MAQUET authorized personnel only.
- When lifting or moving the ventilator system or parts of the system, follow established ergonomic guidelines, ask for assistance, and take appropriate safety precautions.
- Before use, make sure the system version displayed under *Status* corresponds to the system version described in the User's Manual.

- Extra care should be taken when handling tubes, connectors and other parts of the patient circuit. The use of a support arm to relieve the patient from the weight of the tubing system is recommended.
- When using the MCare Remote Service function, install the network cable so that there is no risk of anyone tripping over it.
- Do not leave the patient unattended when connected to the ventilator.
- MAQUET has no responsibility for the safe operation of the SERVO-i Ventilator System if the *Intended Use* requirements specified in this document are not followed.
- Contact a MAQUET representative regarding decommissioning of the equipment.
- Disconnect the mains power cable from the outlet to isolate the ventilator from mains power.
- Do not touch accessible connector contacts and the patient simultaneously.

Important:

- Always use a heat and moisture exchanger (HME) or equipment to prevent dehydration of lung tissue.
- While the SERVO-i Ventilator System is in use, the wheels of the carrier shall be locked and the carrier shall be in a horizontal position.
- Securely attach all cables, etc, to minimize the risk of unintentional disconnection.
- Extra care should be taken when handling the gas trolley, as it may tip over.
- All excess fluids must be disposed according to hospital routines.

1.2.2 POWER SUPPLY

WARNINGS!

- The power cord must be connected only to a properly grounded AC electrical outlet to avoid the risk of electrical shock.
- To guarantee reliable battery backup, at least two fully charged battery modules must be installed at all times.

CAUTIONS:

- Do NOT use antistatic or electrically conductive tubing with this system.
- Avoid contact with external electrical connector pins.
- Unused module compartments should always contain an empty module to protect the electrical connector pins from spillage and dust.

1.2.3 FIRE HAZARD

WARNINGS!

- Keep the system and its gas hoses clear of all ignition sources.
- Do not use the system with worn or frayed hoses or hoses that have been contaminated by combustible materials such as grease or oil.
- Oxygen-enriched gas is extremely flammable: if you detect a burning odor, disconnect the oxygen supply, mains power and remove the batteries.
- Make sure that both the mains power outlet and the power supply connector are accessible.

1.2.4 GASES

CAUTION: The system is not intended to be used with any anesthetic agent.

Important:

- Supplied gases shall meet the requirements for medical grade gases according to applicable standards.

Maximum levels:

Air

- $H_2O < 7 \text{ g/m}^3$
- Oil $< 0.5 \text{ mg/m}^3$
- Chlorine: must not be detectable ¹

Oxygen

- $H_2O < 20 \text{ mg/m}^3$
- Oil $< 0.3 \text{ mg/m}^3$

Note: For devices with serial numbers below 70000 that are updated to version 7.0, the maximum inlet gas pressure will be reduced (see the Technical data chapter on page 220).

1.2.5 AUXILIARY EQUIPMENT

CAUTIONS:

- Accessories, supplies, and auxiliary equipment used with the ventilator should:
 - be recommended by MAQUET
 - meet IEC 60601-1 standards
 - meet IEC standards as a whole system
- If a scavenging system (i.e. gas evacuation) is connected to the ventilator, it must conform to ISO8835-3 guidelines for subatmospheric pressure and induced flow.
- Measurements of parameter values that have been processed by auxiliary equipment:
 - may be inaccurate if equipment not authorized by MAQUET is used
 - should be disregarded if they conflict with information on the ventilator screen
 - must not substitute for therapeutic or diagnostic decisions

Note: Applied parts, i.e. equipment making physical contact with the patient, comprise nebulizer patient unit and cable, Y Sensor, CO₂ sensor, Edi Catheter and cable and the Ventilator Breathing System described in System Flow Chart, Ventilation, Patient Connection, part no. 66 92 522.

1. If the compressed air is generated by a liquid ring compressor there is a potential risk of chlorine in the supplied air.

1.3 VERSION AND CONFIGURATIONS

This manual applies to version 7.1 of the SERVO-i Ventilator System, which can be delivered in three configurations: SERVO-i Infant; SERVO-i Adult and SERVO-i Universal.

1.3.1 CONFIGURATIONS

The weight ranges served by each configuration of the SERVO-i Ventilator System.

The SERVO-i Ventilator System can be used in both invasive and non invasive ventilation.

Configuration	Weight range				
	Invasive ventilation	Non invasive ventilation			
		Adult	NIV PC + PS Infant	NIV NAVA Infant	NIV Nasal CPAP
SERVO-i Infant	0.5 kg – 30 kg	Not Applicable	3 kg – 30 kg	0.5 kg – 30 kg	0.5 kg – 10 kg
SERVO-i Adult	10 kg – 250 kg	10 kg – 250 kg	Not Applicable	Not Applicable	Not Applicable
SERVO-i Universal	0.5 kg – 250 kg	10 kg – 250 kg	3 kg – 30 kg	0.5 kg – 30 kg	0.5 kg – 10 kg

NIV = Non Invasive Ventilation

1.3.2 CONFIGURATION LABELS



SERVO-i Universal



NAVA ready



SERVO-i Adult



NAVA



SERVO-i Infant

1.3.3 AVAILABLE OPTIONS

The SERVO-i Ventilator System Configurations - lists the available functions and indicates if included or optional with each configuration



Infant



Standard
Configuration



Adult



























































Options



Universal



Not applicable

							
NIV NAVA				Bi-Vent/APRV			
NAVA				VS (Volume Support)			
Nasal CPAP				PRVC (incl. SIMV (PRVC) + PS)			
Non Invasive Ventilation (NIV)				VC (incl. SIMV (VC) + PS)			
Y Sensor Measuring				PC (incl. SIMV (PC) + PS)			
CO ₂ Analyzer				PS/CPAP			
Nebulizer							
Heliox							
Stress Index							
Open Lung Tool [®] (OLT)							
Automode [®]							

2 SYSTEM OVERVIEW

TABLE OF CONTENTS

2.1	Ventilator		18
2.2	User Interface - Connections, labels and symbols		19
2.3	Navigating the User Interface		22
2.4	Patient Unit - Connections, labels and symbols		28
2.5	Transport and storage		34

2.1 VENTILATOR

The User Interface is used to control ventilator settings. Settings may be adjusted using touchpads on the screen or a rotary dial.

Breathing parameters are continuously measured and controlled. A difference between the actual measured value of a parameter and the preset or calculated value results in the adjustment of gas delivery to achieve the target value.

The system has two gas modules, one for air and one for O₂. Gases may be supplied by a medical pipeline system, a compressor, or by gas tanks.

Ensure that the ventilator is in its locked position on the cart or holder used, to prevent unintentional movements.

CAUTION: Lock the wheels if the ventilator is not to be used for transportation.

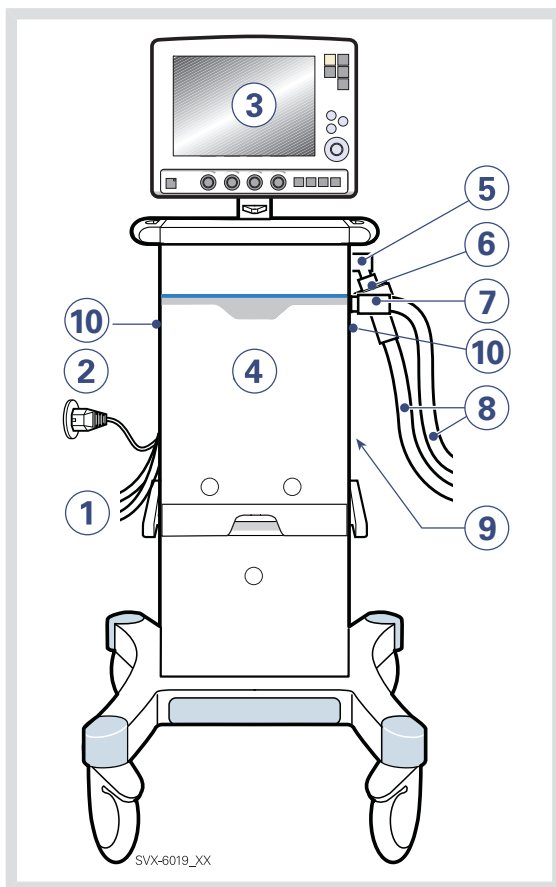

1. Air and O₂ supply
2. Power cable
3. User Interface
4. Patient Unit
5. Expiratory inlet
6. Servo Duo Guard, viral/bacterial filter
7. Inspiratory outlet
8. Patient circuit
9. Module compartment
10. Emergency air intake

2.2 USER INTERFACE - CONNECTIONS, LABELS AND SYMBOLS

The User Interface includes:

- a screen with active touchpads
- fixed keys
- rotary dials

2.2.1 USER INTERFACE DIAGRAM

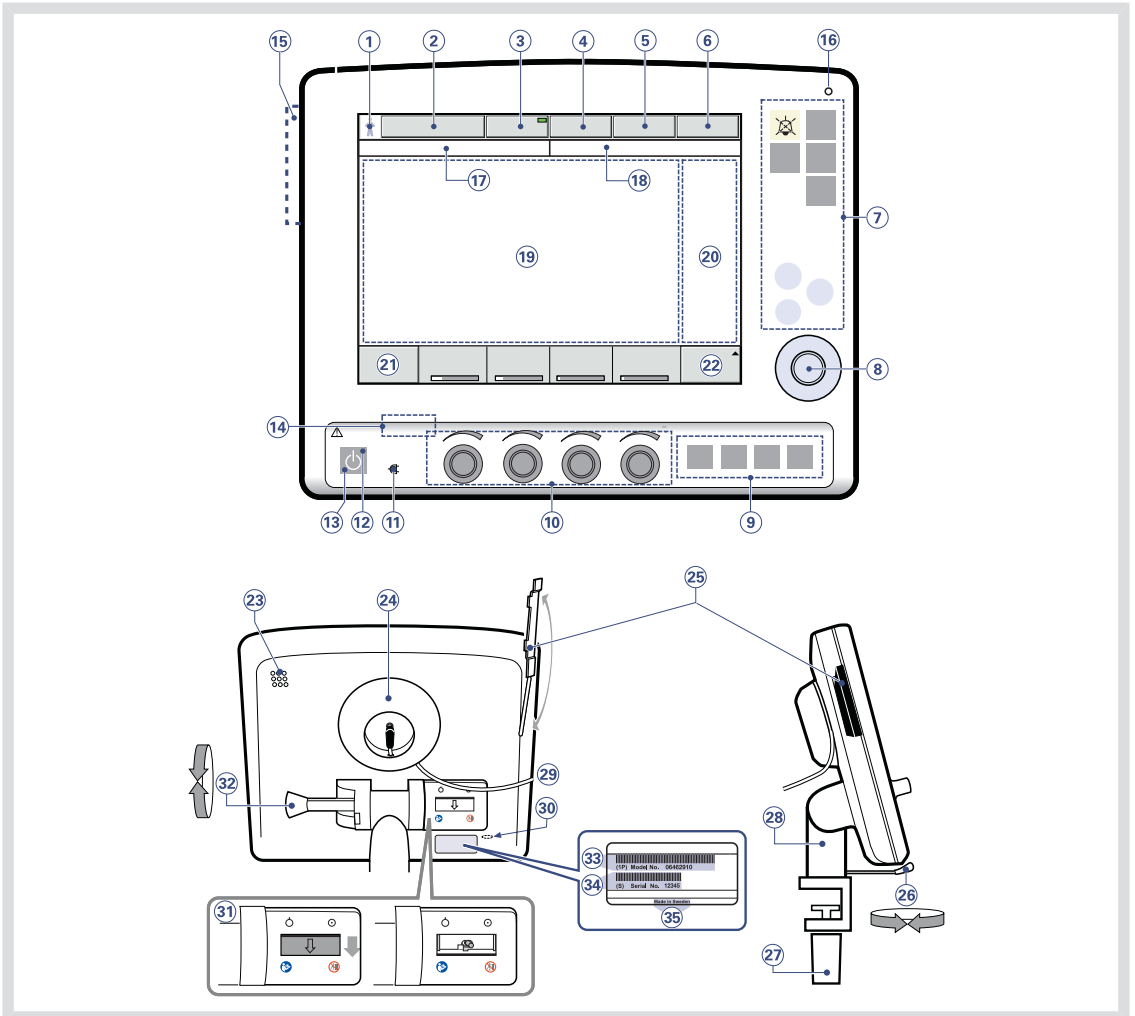

















2.2.2 USER INTERFACE COMPONENTS

Refer to the User Interface Diagram for the location of the following numbered components:

1. Current Patient category
2. Current mode of ventilation
3. Automode On/Off (option)
4. Admit patient/Entered patient data and admission date
5. Nebulizer On/Off (option)
6. System status parameters
7. Fixed keys
8. Main Rotary Dial—used to select a menu touchpad or parameter box, to adjust values, and to confirm settings
9. Special Function Keys—used to start special ventilatory functions
10. Direct Access Knobs—used for immediate adjustment of breathing parameters
11. AC Power indicator (green)
12. Standby indicator (yellow)—when the ventilator is in Standby, a flashing message, *Patient not ventilated*, is displayed on the screen directly above the word Standby.
13. Start/Standby key
14. On/Off switch (rear side)
15. Slot for Ventilation Record Card (front view)
16. Luminescence detector—for automatically adjusting screen brightness
17. Text messages, including patient triggering symbols
18. Alarm messages
19. Waveform area—for monitoring two to four individually scaled parameters, including a volume/pressure loop and a flow/volume loop
20. Measured values and alarm limits display (customizable)
21. Additional settings
22. Additional measured values
23. Loudspeaker
24. Cable reel for the control cable
25. Slot for Ventilation Record Card (side/rear view)
26. Locking lever for rotation
27. Locking screw for alternative cart mounting
28. Holder for positioning on the Mobile Cart
29. Control cable (2.9 m long)
30. Service connector
31. On/Off switch
32. Locking lever for tilting
33. Model number
34. Serial number
35. Manufacturing information

2.2.3 USER INTERFACE SYMBOLS

Symbol	Description
	Audio Pause - silence or confirm an alarm. Note: This symbol may be different depending on User interface version.
	Audio off
	Audio Pause - all alarms, active and inactive, are pre-silenced.
	Alarm on
	Alarm off
	Attention—consult documentation Note: This symbol may be different depending on User Interface version
	Do not push the User Interface as the ventilator may tip over.
	Start ventilation/Standby—yellow indicates Standby
	Power indicator—green indicates AC power connected
	Battery—indicates ventilator is using battery power, with estimated minutes remaining
12 V	12 V - indicates that external 12V DC is connected.
	ON/OFF switch
	Trigger indication—appears in the message/alarm field when the patient triggers a breath
HeO ₂	Indicates that the system is compensated for Heliox.
	Infant patient category
	Adult patient category
	Volume Control with flow adaptation
	Volume Control without flow adaptation

Symbol	Description
	Volume Control with decelerating flow

Note: The patient unit symbols are described later in this chapter.

2.3 NAVIGATING THE USER INTERFACE

The following subsections provide general procedures for working with the user interface. More detailed procedures for specific tasks are found in later chapters and in the *Appendix*.

2.3.1 TOUCH SCREEN

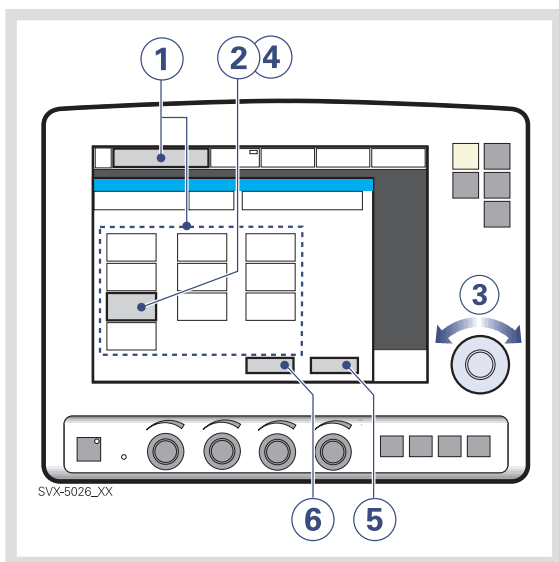

To adjust ventilator settings:

1. Open the desired window by pressing one of the touchpads on the screen or one of the fixed keys.
2. Activate the desired touchpad by pressing it. The touchpad is now highlighted in white with a blue frame and it is possible to set a new value.
3. Turn the Main Rotary Dial to the desired value.
4. Confirm the settings by pressing the parameter touchpad or by pressing the Main Rotary Dial.
5. The touchpad turns grey again indicating that the new setting has been entered.
6. Press *Accept* to activate the new settings, or *Cancel* to start over.

Important: Different ways of interacting with the screen will affect its lifetime. Never use any sharp or pointed objects, such as ballpoint pens, on the screen.

2.3.2 MAIN ROTARY DIAL

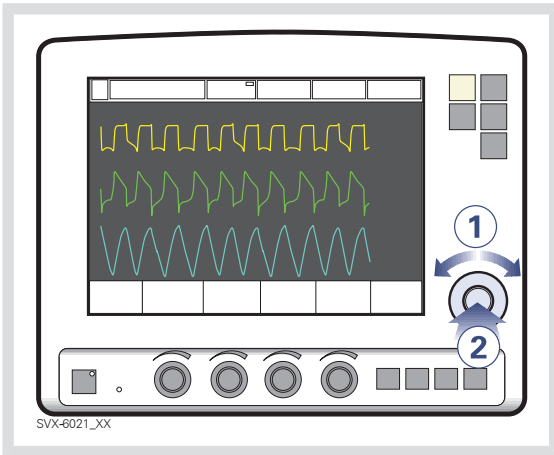

To use an alternative method for adjusting ventilator settings once the desired menu is activated:

1. Turn the Main Rotary Dial until the desired menu touchpad is marked with a blue frame.
2. Press the Main Rotary Dial to confirm. The menu touchpad is highlighted in white with a blue frame, indicating that a new value can be entered.
3. Turn the Main Rotary Dial to the desired value or line.

4. Confirm the setting by pressing the Main Rotary Dial. The parameter touchpad turns grey again indicating that a new setting has been entered.
5. Touch *Accept* to activate your settings, or *Cancel* to start over.

Note: When the defined safety limits for a given parameter have been reached, the Main Rotary Dial becomes inoperative for 2 seconds to indicate that a safety limit has been reached.

2.3.3 FIXED KEYS

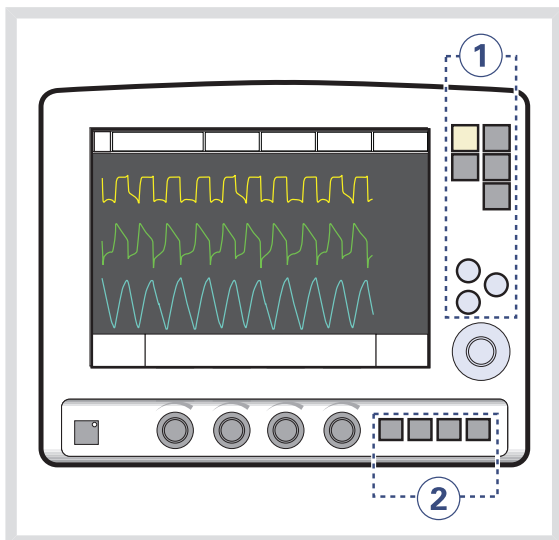

There are two groups of fixed keys on the user interface screen:

- The keys in group 1 activate user interface functions such as *Save* and access various screens such as *Menu*.
- The keys in group 2 start special ventilatory functions

Important: The special ventilatory functions require continuous supervision.

2.3.4 DIRECT ACCESS KNOBS

The four dials along the bottom of the User Interface screen are the Direct Access Knobs. They permit direct control of four breathing parameters, which are automatically selected depending on ventilation mode.

Using Direct Access Knobs

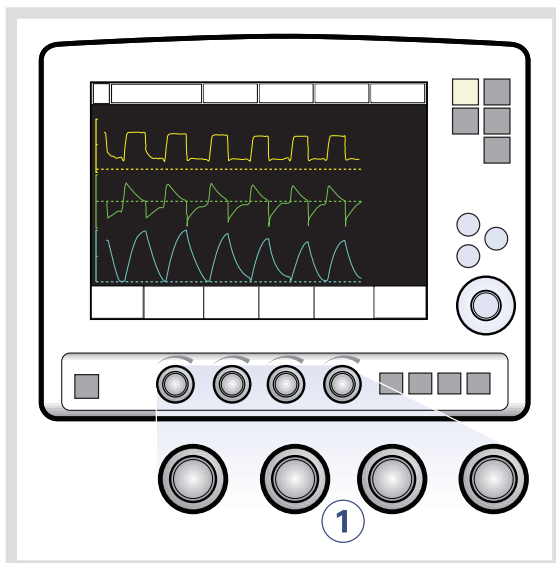

To adjust a breathing parameter directly:

1. Turn the Direct Access Knob corresponding to the parameter you wish to change until the desired value is displayed on the screen.

WARNING! When you adjust a breathing parameter using a Direct Access Knob, the parameter will change immediately starting with the next breath; no additional confirmation is required.

The Main Rotary Dial and Direct Access Knobs become inoperative for 2 seconds when the user reaches a defined safety limit for the parameter being adjusted.

Direct Access Knobs - Safety

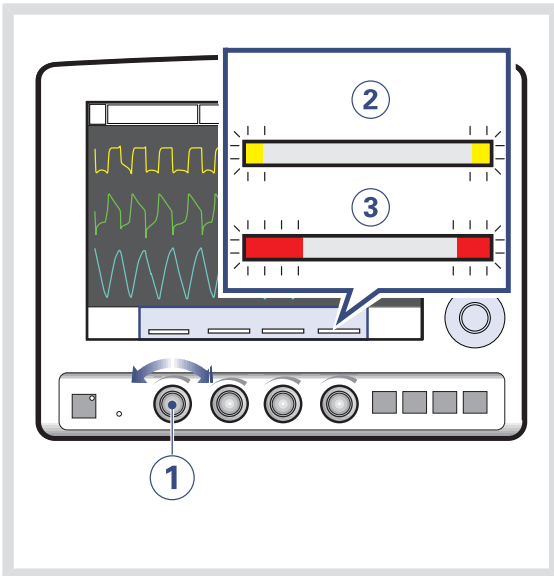

Note: When the defined safety limits for a given parameter have been reached, the Direct Access Knob becomes inoperative for 2 seconds to indicate that a safety limit has been reached.

The four Direct Access Knob parameters are displayed at the bottom of the screen with color-coded bars that indicate whether the parameter values are within generally-recognized safety limits.

The figure above shows the following components.

1. A Direct Access Knob
2. A yellow bar indicating the corresponding parameter value is outside safety limits; a text message is displayed accompanied by an audible signal.
3. A red bar indicating the corresponding parameter value is *significantly* outside safety limits; a text message is displayed accompanied by an audible signal.

2.3.5 MENU KEY

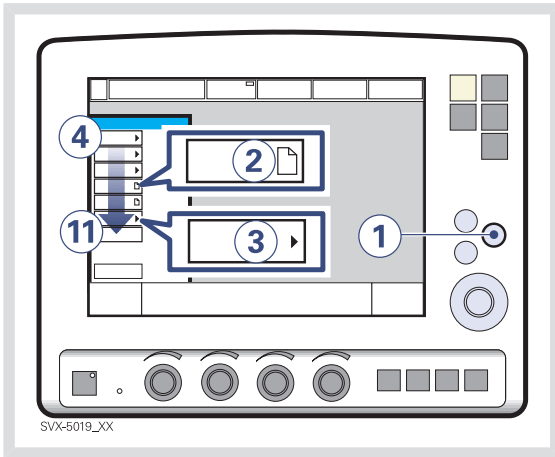

Press any of the following touchpads.

4. *Alarm*
5. *Review*
6. *Options*
7. *Compensate*
8. *Copy (to Ventilation Record Card)*
9. *Biomed*
10. *Panel lock*
11. *Change patient category (option)*

For more information see Appendix • User interface on page 253.

To access the user interface windows:

1. Press the fixed key *Menu*.
Touchpads leading to the user interface windows appear.
2. If the touchpad shows a sheet icon, press the touchpad to open a user interface window, OR
3. If the touchpad shows an arrow icon, press the touchpad to display the submenu.

2.3.6 STATUS TOUCHPAD

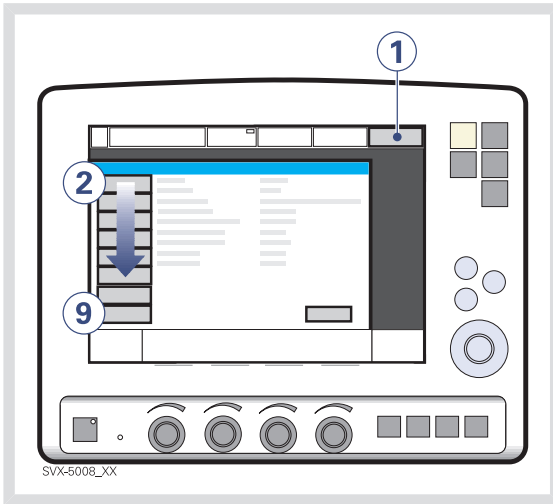

The Status touchpad indicates the power supply currently being used by the ventilator (AC power, battery power, or external 12V DC power). If the ventilator is running on battery power, the estimated remaining battery time in minutes is shown.

CAUTION: When using an external 12V DC supply, battery modules must be installed to ensure proper operation.

To access the status window:

1. Press the *Status* touchpad.

Touchpads leading to status windows appear.

Press any of the following touchpads.

2. *General*
3. *O₂ cell / O₂ Sensor*
4. *Expiratory cassette*
5. *Batteries*
6. *Modules - CO₂ module (if fitted), Y Sensor measuring (if fitted), Edi module (if fitted)*
7. *Installed Options*
8. *Pre-use check*
9. *Patient Circuit*

2.4 PATIENT UNIT - CONNECTIONS, LABELS AND SYMBOLS

The patient unit consists of the following components:

- gas supplies and their connectors
- power supplies and their connectors
- connectors for accessories

2.4.1 PATIENT UNIT DIAGRAM

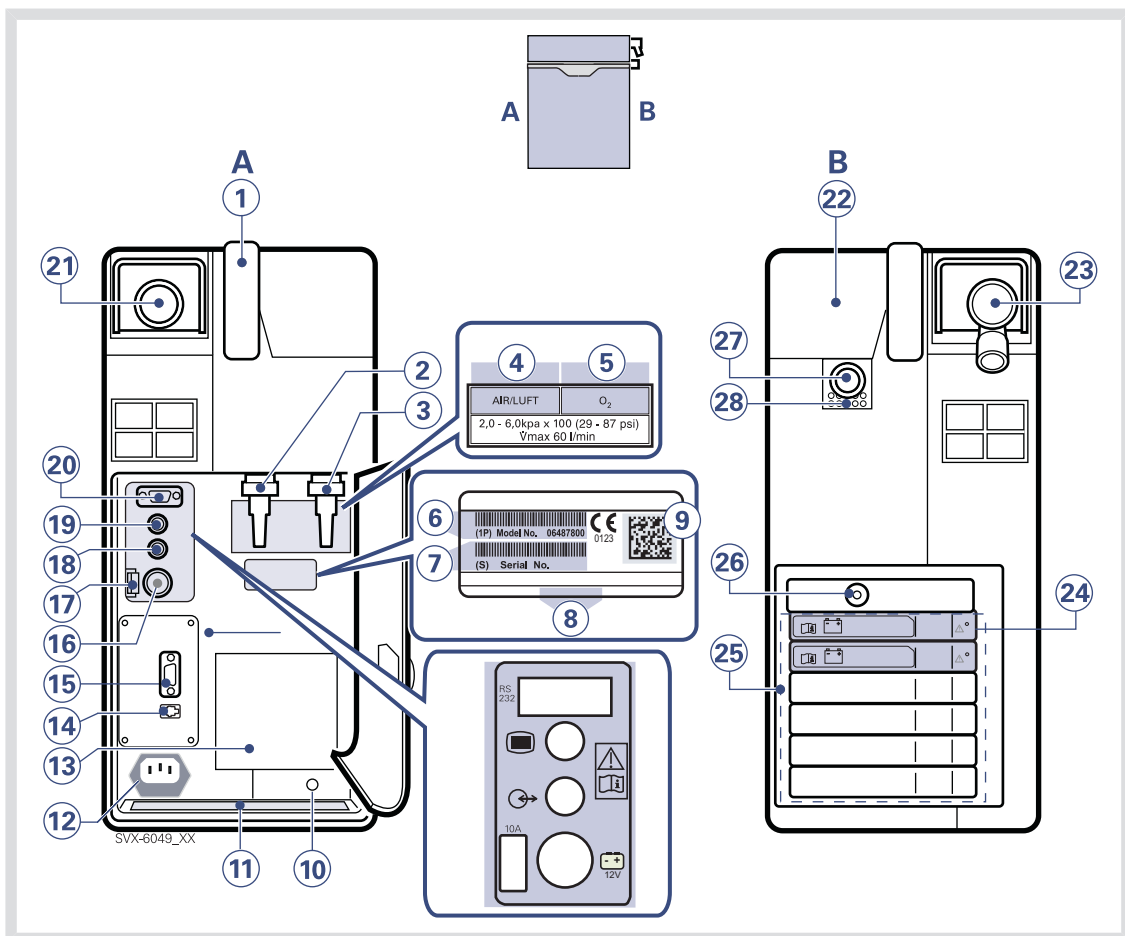

2.4.2 PATIENT UNIT COMPONENTS

Refer to the Patient Unit Diagram for the location of the following numbered components:













A













1. Handle
2. Gas inlet for air
3. Gas inlet for O₂
4. Air / Luft
5. O₂
6. Model number
7. Serial number
8. Manufacturing information
9. UDI label
10. Equipotentiality terminal
11. Label
12. AC power supply connector with fuse
13. Cooling fan with filter
14. Alarm output connection
15. RS-232 connector
16. External +12V DC inlet
17. Fuse for external DC power supply
18. Optional connector
19. User interface connector
20. RS-232 connector
21. Expiratory outlet

B

22. Cover, inspiratory channel
23. Expiratory inlet
24. Battery lock
25. Module compartment
26. Nebulizer connector
27. Inspiratory outlet
28. Emergency air intake

2.4.3 PATIENT UNIT SYMBOLS

Symbol	Explanation
	CE label indicates compliance with the requirements of the Medical Device Directive 93/42/EEC
	CSA label—Indicates compliance with Canadian and US standards
	PCT label - indicates compliance with Russian standards
	UDI Label - Unique Device Identification. See technical specifications, page 248.
	Manufacturer
	Manufacturing date
	Order number
	Number to identify the production batch
	Class I equipment, Type B—indicates classification according to IEC 60601-1/EN 60601-1
	Equipotentiality terminal Note: The equipotentiality terminal is designed for the connection of a potential equalization conductor according to DIN 42 801 and EN/IEC 60601-1. The function of the equipotentiality terminal is to equalize potentials between the system and other medical electrical devices that can be touched simultaneously. The equipotentiality terminal must not be used for a protective earth connection.
	Nebulizer Connector
	RS 232 / Serial port—connector for data communication. Note: This symbol may be different depending on Patient Unit version.

Symbol	Explanation
	User Interface connector Note: This symbol may be different depending on Patient Unit version.
	Optional connector / Expansion Note: This symbol may be different depending on Patient Unit version.
	10A Fuse for external DC power supply.
	External 12V DC input Note: This symbol may be different depending on Patient Unit version.
	Expiratory label—gas flow from patient.
	Inspiratory label—gas flow to patient.
	Gas exhaust port label—exhaust gas flow from ventilator Note: This port should not be connected to a spirometer because the volume through the exhaust port is not equal to the expired volume from the patient.
	Alarm output connection—external alarm output communication
	Special waste. This product contains electronic and electrical components. Discard disposable, replaced and left-over parts in accordance with appropriate industrial and environmental standards.
	Caution
	Consult Instructions for use
	Batteries
	20 kg Weight - Patient unit and User interface.

2.4.4 PATIENT UNIT GAS FLOW DIAGRAM

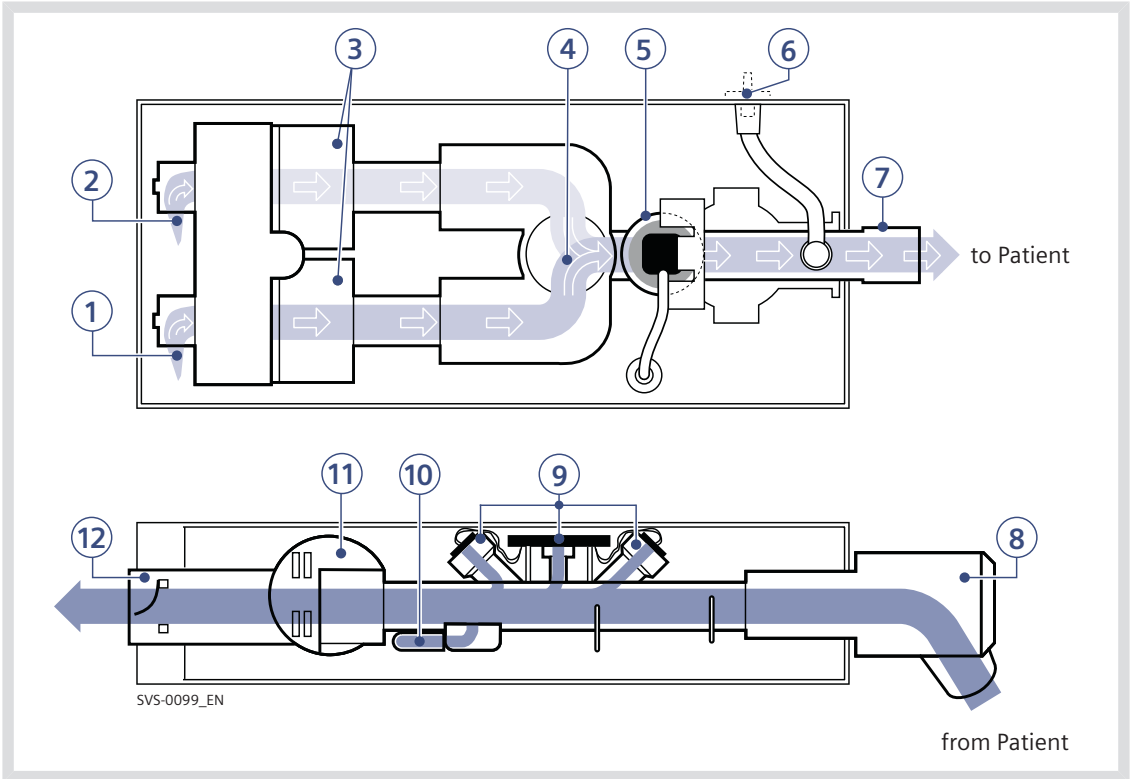

2.4.5 GAS FLOW THROUGH THE PATIENT UNIT

Refer to the Patient Unit gas flow diagram for the location of the following numbered components:

1. Gas inlet for O₂
2. Gas inlet for air
3. The gas flow is regulated by the gas modules for Air and O₂.
4. The gases are mixed in the inspiratory mixing section.
5. The Oxygen concentration can be measured with an O₂ cell or O₂ sensor.
An O₂ cell is shown here.
The O₂ cell is protected by a bacteria filter.
6. The pressure of the mixed gas delivered to the patient is measured by the Inspiratory pressure transducer.
The transducer is protected by a bacterial filter.
7. The inspiratory channel delivers the mixed gas to the patient systems inspiratory tubing. The inspiratory channel also contains a safety valve.
8. The patient breathing systems expiratory tubing is connected to the expiratory inlet. The inlet also contains a moisture trap.

9. The gas flow through the expiratory channel is measured by ultrasonic transducers.
10. The expiratory pressure is measured by the expiratory pressure transducer (located inside the ventilator). The transducer is protected by a bacterial filter inside the expiratory cassette.
11. The pressure (PEEP) in the patient system is regulated by the expiratory valve.
12. Gas from the patient system leaves the ventilator via the expiratory outlet. The outlet contains a non-return valve.

Note: The expiratory cassette can be exchanged between different SERVO-s and SERVO-i Ventilator Systems. Always perform a Pre-use check after exchanging an expiratory cassette.

2.4.6 SYMBOLS ON ACCESSORIES AND PACKAGING

Symbol	Explanation
	Order number
	Number to identify the production batch
QTY	Quantity
	Outer diameter in millimeters
	Inner diameter in millimeters
Fr/cm	Circumference/length
	Use by date
	Do not re-use. Single use only.
	Do not use if packaging is damaged
	Attention—consult documentation
	Keep away from sunlight
	Method of sterilization using irradiation
	Manufacturer
	CE label—indicates compliance with the requirements of the Medical Device Directive 93/42/EEC
	Manufacturing date
	Phthalates
	Federal law restricts this device to sale by or on the order of a physician.
	Recycling. Worn-out batteries must be recycled or disposed of properly in accordance with appropriate industrial and environmental standards.
	Hazardous waste (infectious) The device contains parts which must not be disposed of with ordinary waste.
	Indicates the inner diameter of the endotracheal tube.

Symbol	Explanation
	Humidity limitation
	Temperature limitation
	Phthalate free
	Defibrillation proof Type CF applied part - indicates classification according to IEC 60601-1
	Output
	Type BF applied part — indicates classification according to IEC 60601-1/EN 60601-1
	Type B—indicates classification according to IEC 60601-1/EN 60601-1
	Fragile - handle with care
	Keep away from water
	This way up - indicates correct upright position of the transport package
	Atmospheric pressure limitation
	Do not expose the battery to heat or fire.
	Do not expose the battery to mechanical force.
	Do not dismantle, open or shred the battery.
	The support arm must be folded during transport.
	Consult Instructions for use

2.5 TRANSPORT AND STORAGE

2.5.1 BEFORE INTRAHOSPITAL TRANSPORT

Before transporting the ventilator with or without a patient connected, follow facility guidelines and:

- Be sure the patient unit and the user interface are securely attached and locked.
- Be sure all accessories such as modules, gas cylinders, and humidifier are securely attached and locked.
- Be sure the gas cylinders are connected and have sufficient gas.
- Be sure the batteries are fully charged.

Important: At least two batteries should be connected during transport.

- Inspect the resuscitator.
- Inspect the Mobile Cart for damage.
- Be sure the straps are firmly wrapped across the center of the gas cylinders so that the cylinders do not move during transport.
- Be sure that the support arm is folded before transport.

2.5.2 DURING INTRAHOSPITAL TRANSPORT

While transporting the ventilator with or without a patient connected, follow facility guidelines and:

- Use the handles on the Mobile Cart.
- Transport the bed and the ventilator slowly, and watch the patient connection carefully to see that no pulling or other movement occurs.
- When moving the Support Arm or changing position, watch the patient connection carefully to see that no pulling or other movement occurs.
- Be careful not to tip the Mobile Cart when crossing an obstacle like a doorstep.

2.5.3 STORAGE

- When the SERVO-i Ventilator System is in storage, keep the ventilator connected to mains power to maintain full charge in the batteries.
- Do not dispose of battery modules and O₂ cells with ordinary waste.
- Be sure the system is not exposed to temperatures below +10°C or above +40°C.
- Be sure the system is not exposed to a relative humidity above 95%.

3 POWER SUPPLY

TABLE OF CONTENTS

3.1	Introduction		36
3.2	Viewing battery status		36
3.3	Alarms and safety		38

3.1 INTRODUCTION

The SERVO-i Ventilator System is equipped with an AC power supply with automatic range selection. The ventilator will automatically operate correctly using 100-120V AC or 220 - 240V AC outlets.

See chapter Technical data on page 219.

The ventilator is equipped with at least two battery modules which automatically supply 12V DC power in case of an AC power failure, ensuring that ventilator settings and stored data remain intact in the event of an AC power failure.

Note: Batteries can be added to available slots during operation.

The ventilator also comes equipped with an inlet for an external 12V DC power supply. This power supply activates automatically in case of an AC power failure, and ventilator settings and stored data remain intact.

CAUTION: When using external 12V DC, at least two installed battery modules are required to ensure proper operation.

When the system is connected to an external power supply, all connected battery modules are being recharged. This does not affect ventilation.

Alarms and Messages

See *Alarms* and *Safety* later in this chapter.

When the ventilator is turned off with the on/off switch, batteries continue to charge.

3.2 VIEWING BATTERY STATUS

When operating from batteries, the estimated remaining battery time in minutes is displayed in the upper right corner of the screen on the *Status* touch pad.

WARNING! If the remaining battery time on the *Status* touchpad is displayed in red, the battery modules have very little operational time left and battery modules must be replaced. If possible, connect the ventilator to AC power.

Note: The total usable backup time is the sum of the estimated operation time displayed for each battery module minus 10 minutes.

Detailed battery status information is available via the Battery Status Window:

1. Press the *Status* touchpad at the top-right of the user interface to display the *Status Window*.

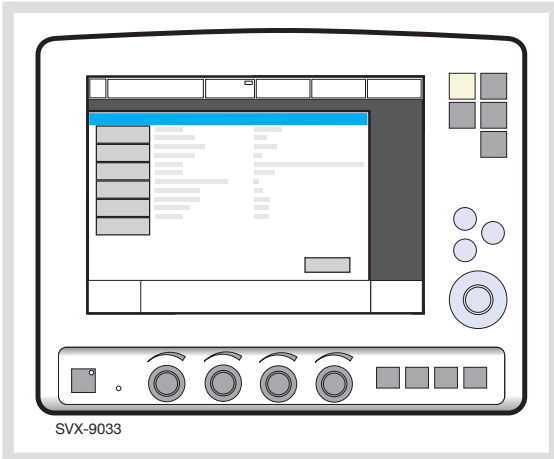

2. Press the *Batteries* touchpad to display the *Battery Status Window*.

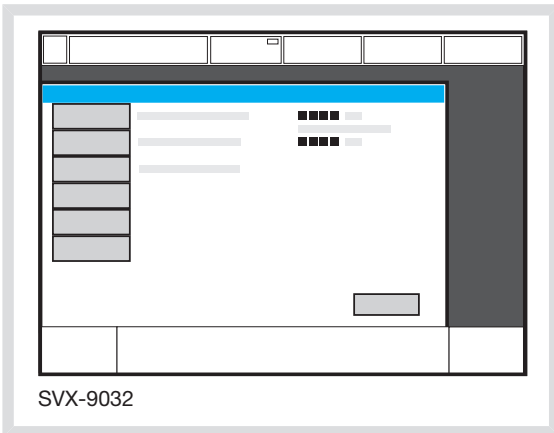

The following information is displayed for each mounted battery module:

- Slot number
- Serial number
- Charge indicator, where
 - 0 boxes filled = < 10% relative charge
 - 1 box filled = 10-25% relative charge
 - 2 boxes filled = 26-50% relative charge
 - 3 boxes filled = 51-75% relative charge
 - 4 boxes filled = 76-100% relative charge,
- Remaining operating time in minutes
- Activity Instruction—an instruction may be displayed next to the remaining operating time in minutes:

Activity Instruction	Response
<i>Expires soon</i>	Order a new battery module.
<i>Replace battery</i>	The battery no longer reliable; replace it immediately.

Note: If the *Replace battery* is displayed, the battery has become unreliable, regardless of the operating time displayed in the Battery Status Window. In this situation, replace the battery even when the status window indicates significant operating time remains.

3.3 ALARMS AND SAFETY

The status of the battery modules is continuously monitored by the ventilator. If the status is unsatisfactory, four types of messages may be displayed at the top of the user interface:

- Technical Error Message
- High Priority Alarm Message
- Medium Priority Alarm Message
- Low Priority Alarm Message
- Informative Text Message

3.3.1 WARNINGS

WARNINGS!

- If a battery status message is displayed on the user interface, check the battery status as soon as possible. If no action is taken, the ventilator may eventually shut down.
- To guarantee reliable battery backup, at least two fully charged battery modules must be installed at all times.
- Always replace batteries when the ventilator software notifies you of imminent expiration or of diminished operating capacity.
- Do not disconnect and store battery modules over long periods of time because this will degrade their capacity. If used battery modules need to be stored for short periods of time (up to one week), then store them fully charged in a cool (15-20°C or 59-68°F), dry environment.

- Batteries that have been stored or disconnected should be recharged before use.
- Dispose of batteries according to local regulations and not with ordinary waste.
- After a new battery module is installed, display the Battery Status Window to ensure safe battery operation.
- When delivered, the battery modules may not be fully charged. Check the status of the batteries via the user interface and, if necessary, charge the battery before use by connecting the ventilator to the power supply.
- Always recharge discharged batteries.
- When not in use, the ventilator should always be connected to the power supply to ensure fully charged batteries.
- When the ventilator is running on batteries, the Servo Ultra Nebulizer is disabled to reduce power consumption.

3.3.2 STATUS MESSAGES

Message (message type)	Explanation
<i>Technical error no. 1 - 6, 29, 10001</i> (technical error)	Power failure.
<i>Check battery status</i> (Text Message)	There is a problem with the battery modules. One or more battery modules must be replaced.
<i>Nebulizer cannot be run on one battery</i> (Text message)	When using an Aeroneb module installed by MAQUET and any Aeroneb nebulizer unit, nebulization cannot be maintained with less than two batteries installed.
<i>Battery mode! Nebulizer switched off</i> (Medium Priority Alarm)	Ventilator is running on batteries and the Servo Ultra Nebulizer has been disabled to reduce the power consumption.
<i>Battery operation</i> (Low Priority Alarm)	AC power is off line due to a power failure or disconnection.
<i>Limited battery capacity</i> (Medium Priority Alarm)	Less than 10 minutes left of battery operation.
<i>No battery capacity</i> (High Priority Alarm)	Less than 3 minutes left of battery operation.
<i>Low battery voltage</i> (High Priority Alarm)	Battery voltage too low. Cannot guarantee continued ventilator operation.

3.3.3 AC POWER FAILURE

In the event of an AC power failure or disconnection, the ventilator switches to battery operation and activates low/medium priority alarms.

4 OPERATION OVERVIEW

TABLE OF CONTENTS

4.1	Workflow summary		42
4.2	Pre-use check		42
4.3	Patient circuit test		50
4.4	Select patient category (option).		51
4.5	Enter the patient data		52
4.6	Select the Type of Ventilation (Options)		53
4.7	Set ventilation mode		54
4.8	Set alarm limits		55
4.9	Start ventilation		56
4.10	Additional settings window		57
4.11	Suctioning		58
4.12	Re-adjust the Oxygen cell		60
4.13	Disconnect the patient		61

4.1 WORKFLOW SUMMARY

The following summary procedure provides an overview of the operation of the SERVO-i Ventilator System.

1. Turn on the ventilator and perform a Pre-use check. When the ventilator is in Standby, a flashing message, *Patient not ventilated*, is displayed on the screen directly above the word Standby.
2. Select patient category (option).
3. Enter data for the new patient, including height and weight.
4. Select type of ventilation (option).
5. Set the ventilation mode.
6. Check, and if necessary, adjust the alarm profile.
7. Connect ventilator to patient and start ventilation.
8. During ventilation you can:
 - use the *Additional Settings* and *Alarm profile* touchpads to review and adjust settings
 - use suction support
 - adjust the O₂ cell (not when O₂ sensor is used)
9. Disconnect the patient.

The following sections describe each of the above steps in more detail.

4.2 PRE-USE CHECK

The Pre-use check includes tests and measurements of:

- internal technical functionality
- gas supply
- internal leakage
- pressure transducers
- safety valve
- O₂ cell / O₂ sensor
- flow transducers
- battery modules
- patient circuit leakage
- patient circuit compliance
- patient circuit resistance

WARNINGS!

- Always perform a Pre-use check before connecting the ventilator to a patient.
- The volume of the patient circuit used during Pre-use check should be the same as, and must never be higher than, during ventilation e.g. the active humidifier must be filled before Pre-use check.
- The separate Patient Circuit Test that can be performed in Standby does not replace the Pre-use check.
- If any malfunctions are detected during the start-up procedure, see chapter System messages for more information.

WARNINGS!

- Do not connect the ventilator to a patient while a malfunction persists.
- Do not disconnect the expiratory cassette while the ventilator is in operation; if necessary, disconnect the cassette while in Standby.

Important:

- If you change the breathing circuit after completion of the Pre-use check, perform a new Pre-use check or a patient circuit test.
- When the Pre-use check is completed, all possible sources of alarm signals have been verified and the alarm system operates correctly.

4.2.1 PRE-USE CHECK WITH HeO₂

The Pre-use check can be performed with HeO₂ instead of air if desired (only if Heliox option is installed).

Always perform the Pre-use check on a warm expiratory cassette when HeO₂ is used. In order for the expiratory cassette to get warm enough, the system must be in the power-on state for 15-30 minutes.

Note: For optimum Oxygen calibration the HeO₂ gas used should contain 21% Oxygen.

1. Follow the normal Pre-use check procedure.
2. The HeO₂ icon (1) indicates that the ventilator is adjusted for Heliox use.

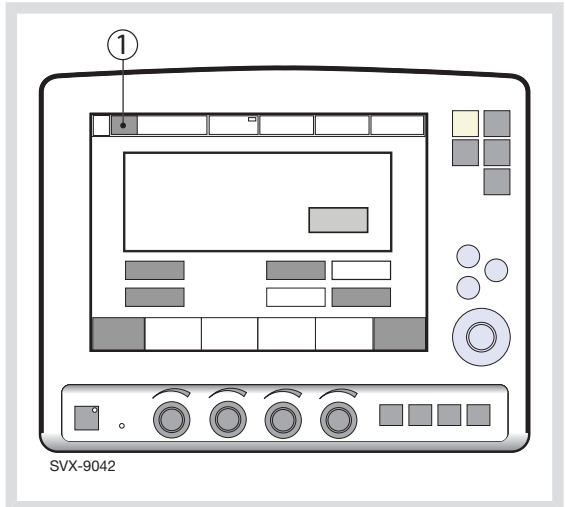

Note: If the identified gas mixture is not approved for use with the SERVO-i Ventilator System (e.g. pure helium or Heliox 70:30), then the *Gas supply test* and *O₂ cell/sensor test* are not passed and the Pre-use check will fail. The message *Unapproved gas mixture identified. Check gas supply* is displayed.

4.2.2 START-UP

1. Connect power and gas supplies:
 - Power: AC outlet
 - Gas: Air and O₂

CAUTION: Ensure that the cable to the User Interface is never disconnected while the SERVO-i Ventilator System is powered on.

2. Turn the ventilator on.

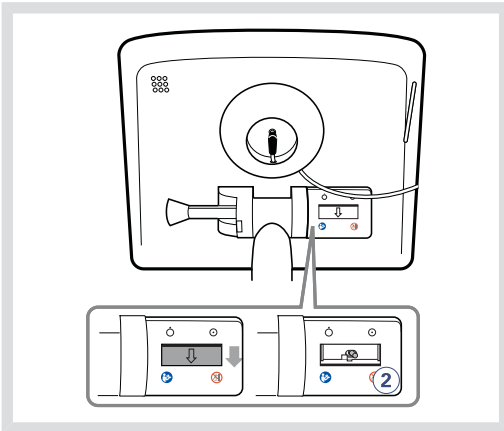

3. Start the Pre-use check by pressing Yes.

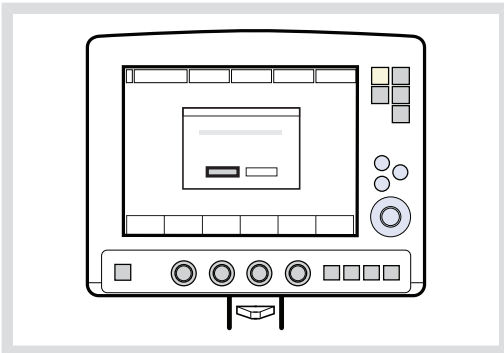

4. Follow the on-screen instructions.
5. After pressing the touchpad *Pre-use check* the message *Do you want to start a pre-use check?* is displayed - confirm by pressing *Yes*.

4.2.3 INTERNAL LEAKAGE TEST

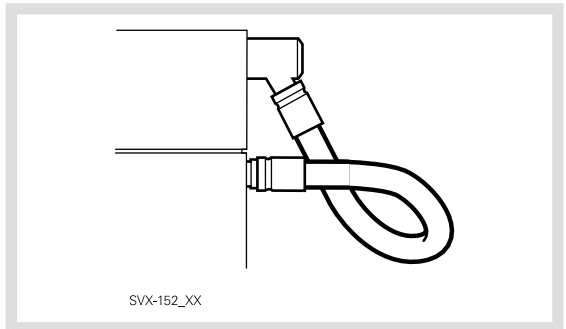

Connect the test tube between the inspiratory outlet and the expiratory inlet.

Important: Use only the MAQUET test tube.

4.2.4 BATTERY SWITCH TEST

The Pre-use check tests the ventilator's ability to switch between AC and battery power when AC power is lost and restored:

- When the on-screen instruction appears, disconnect the ventilator from AC power.
- When the on-screen instruction appears, reconnect the ventilator to AC power.

Note: This test will not be performed if there is less than 10 minutes of battery operation available.

4.2.5 PATIENT CIRCUIT TEST/Y SENSOR TEST

The test measures the compliance and resistance of the patient breathing system.

The patient circuit resistance is automatically measured to determine if the ventilator maintains the specified accuracy with the connected breathing circuit.

1. Connect the complete breathing system to be used on the patient. If an active humidifier is used, it must be filled with water.

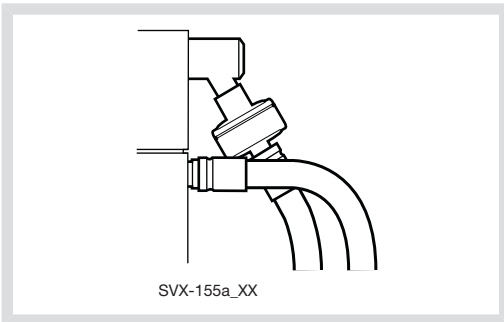

Important: When blocking the end of the complete breathing system, make sure there is no leakage. Leakage will affect the circuit compliance compensation calculation.

2. Block the end of the complete breathing system and follow the on-screen instructions. The circuit compliance and resistance are automatically measured. Go to Compensate for Circuit compliance (see page 46).

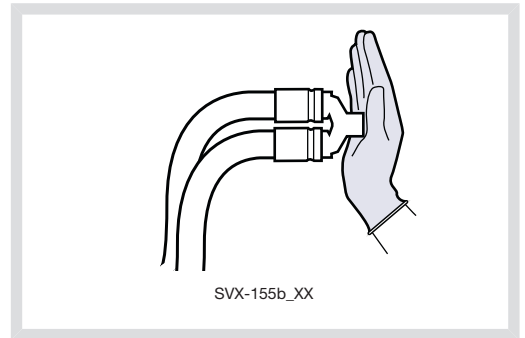

3. Unblock the end of the complete breathing system and follow the on-screen instructions.

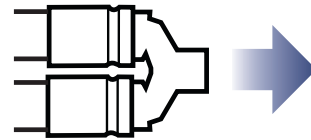

The test will be repeated if a Y sensor is connected. Follow the on-screen instructions.

4.2.6 COMPENSATE FOR CIRCUIT COMPLIANCE

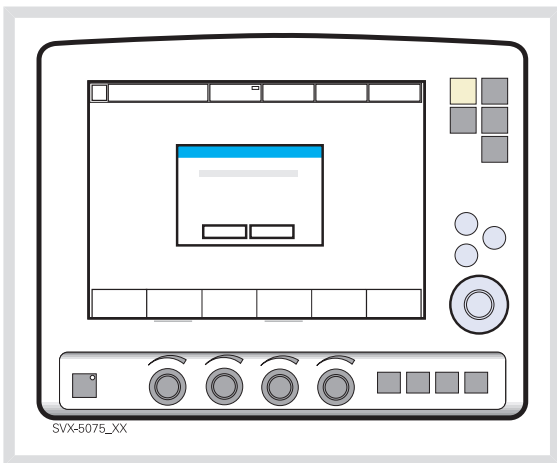

- When the *Compensate for circuit compliance?* dialog appears on the screen, do one of the following:
 - To add the compensation, press Yes (recommended),
 - To refuse the compensation, press No.

Important: If the patient circuit is changed, a Patient Circuit Test must be performed.

Note: Circuit compliance compensation is not available in NIV modes (option).

4.2.7 TEST ALARM OUTPUT CONNECTION (OPTION)

If the Alarm Output Connection option is installed, a dialog for the external alarm system test appears on the screen.

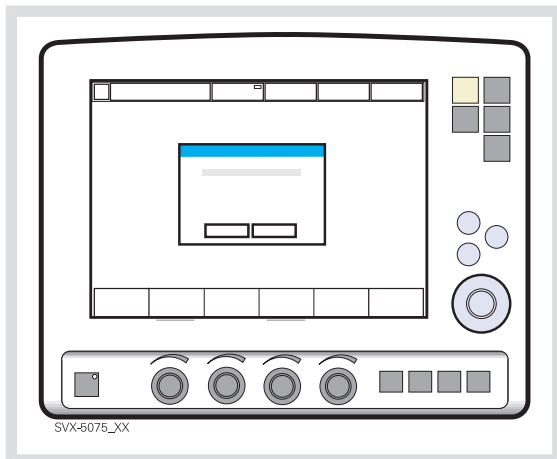

- Do one of the following:
 - To perform the test, press Yes and follow the on-screen instructions.
 - To cancel the test, press No.

4.2.8 COMPLETE THE PRE-USE CHECK

A message appears on screen for each Pre-use check test, as appropriate: Cancelled, Failed, Not Completed, Passed or Running.

- Press *OK* to confirm and to have the Pre-use check tests logged. The ventilator now switches to Standby.

Notes:

- After the Pre-use check is completed (or skipped), you will be prompted to keep or discard old patient-related data.
- By accessing the *Status* menu, the results of the two latest Pre-use checks are displayed under *General*.
- The status of the Patient Circuit test is displayed under *Status/ Patient Circuit*.

4.2.9 PRE-USE CHECK TESTS

Test	Description	Remedy if test fails
<i>Internal test</i>	Audio test and other internal tests (memory and safety-related hardware).	Make sure the patient unit front cover and the user interface rear cover are correctly mounted.
<i>Barometer test</i>	Checks the barometric pressure measured by the internal barometer.	Check the barometric pressure value in the Status Window.
<i>Gas supply test</i>	Checks that the gas supply pressures (air/HeO ₂ and O ₂) measured by the internal gas supply pressure transducers are within the specified range. The test checks the presence of different gas types.	Check that the gas supply pressure (air/HeO ₂ and O ₂) is within the specified range, and that the gas used is approved for the SERVO-i Ventilator System. See page 220 for specification.
<i>Internal leakage test</i>	Checks for internal leakage, with test tube connected, using the inspiratory and expiratory pressure transducers. Allowed leakage: 10 ml/min at 80 cmH ₂ O.	If message <i>Leakage</i> or <i>Excessive leakage</i> appears: <ul style="list-style-type: none"> ■ check that the test tube is correctly connected, ■ check all connections for the expiratory cassette and inspiratory channel, ■ make sure the expiratory cassette and the inspiratory channel are clean and dry, OR ■ contact a service technician.
<i>Pressure transducer test</i>	Calibrates and checks the inspiratory and expiratory pressure transducers.	If the Internal leakage test passed (see above): <ul style="list-style-type: none"> ■ check/replace inspiratory or expiratory pressure transducer ■ check that there is no excess water in the expiratory cassette
<i>Safety valve test</i>	Checks and if necessary adjusts the opening pressure for the safety valve to 117 ± 3 cmH ₂ O.	Check the inspiratory section: <ul style="list-style-type: none"> ■ check that the safety valve membrane is correctly seated in the inspiratory pipe ■ check that the inspiratory pipe is correctly mounted in inspiratory section ■ check that the safety valve closes properly when the Pre-use check is started (distinct clicking sound from the valve)
<i>O₂ cell / sensor test</i>	Calibrates and checks the O ₂ cell / sensor at 21% O ₂ and 100% O ₂ . Checks if the O ₂ cell is worn out. Because different gas mixtures are required for this test, it will not be performed if one gas is missing.	<ul style="list-style-type: none"> ■ Check that the connected gas supply pressure (air and O₂) is within the specified range. ■ Replace the O₂ cell. ■ Replace gas modules (air and/or O₂).

Test	Description	Remedy if test fails
<i>Flow transducer test</i>	Checks the inspiratory flow transducers. Calibrates and checks the expiratory flow transducer.	Check that the connected gas supply pressure (air and O ₂) is within the specified range. Check that the cassette is correctly seated in the cassette compartment.
<i>Battery switch test</i>	If battery modules are installed, tests switching to battery power when AC power is lost and back to AC power when it is restored.	Check that the total remaining time for the connected battery modules are at least 10 minutes. If not, replace the discharged battery with a fully charged battery and repeat the test.
<i>Patient circuit test</i>	Checks the patient circuit leakage, compliance and resistance, with patient tubing connected, using the inspiratory and expiratory pressure transducers. Allowed leakage: 80 ml/min at 50 cmH ₂ O. Will allow the system to calculate a compensation for circuit compliance (if the leakage requirements are met). Checks the patient circuit resistance, with patient tubing connected, using the inspiratory and expiratory pressure transducers. For ranges and accuracies, see chapter Technical data on page 222.	If the internal leakage test has passed, the leakage is located in the patient circuit. Check for leakage or replace the patient circuit.
<i>Y Sensor test</i>	Checks the pressure and flow measurement of the Y Sensor.	Check Y Module and Y Sensor. If the problem persists, change the Y Module/Sensor.
<i>Alarm state test</i>	Checks that no Technical error alarms are active during the Pre-use check	Refer to service technician.
<i>Alarm output connection</i>	Checks that the alarm activation functions correctly.	<ul style="list-style-type: none"> ■ Check that the cable is connected to the external system. ■ Refer to service technician.

4.3 PATIENT CIRCUIT TEST

In Standby, the Patient circuit test may be performed separately from the Pre-use check. This is useful, for example, when changes are made to the circuit or additional accessories are connected. The test evaluates circuit leakage and measures circuit compliance and resistance.

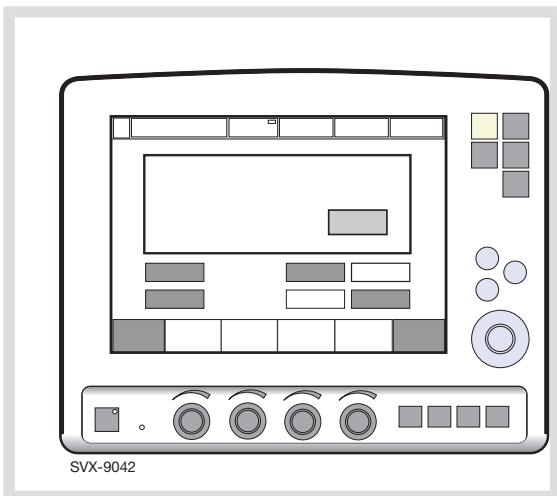

Press the *Patient circuit test* touchpad and follow the on-screen instructions.

Follow the instructions in section *Patient circuit test/Y Sensor test*.

The results from the Patient circuit test is displayed in the *Status>Patient circuit* window.

WARNINGS!

- A Pre-use check must always be done before connecting the ventilator to a patient.
- The Patient circuit test does not replace the Pre-use check.

Note: Considerable leakage may occur around the endotracheal tube if it is uncuffed. The combination of small tidal volumes, leakage around the tube, and activated compliance compensation may trigger the Low Expiratory Minute Volume alarm due to a very low expiratory flow passing from the patient through the expiratory channel. By observing the difference between the Vti and Vte values presented on the user interface, a leakage can be detected and its extent easily controlled. The first time an unacceptably large leakage occurs around the tube, correct this problem to avoid triggering the Low Expiratory Minute Volume alarm. If the leakage persists, either adjust the alarm limit down to its lowest level (10 ml) or permanently silence the alarm (see page 177)—if this step is clinically appropriate. Finally, if the leakage still has not been remedied, deactivate the compliance compensation to avoid triggering the alarm. If the compliance compensation is deactivated while in Pressure Control, Pressure Support, or SIMV (Pressure Control) ventilation modes, then no further settings need to be adjusted. However, in volume-related modes, the set volumes must be adjusted.

4.4 SELECT PATIENT CATEGORY (OPTION).

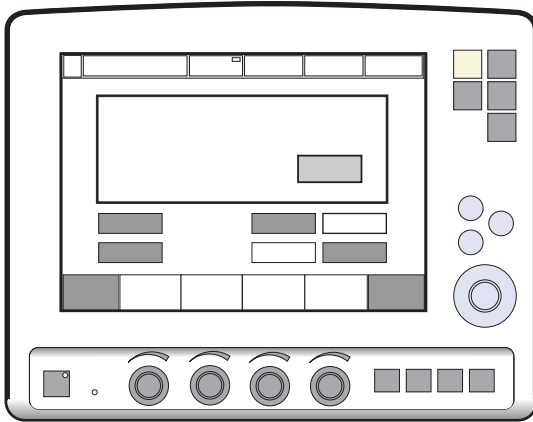

SVX-9042

Press *Adult* or *Infant*.

Note:

Changing the patient category affects the following settings:

- default values for alarm limits
- allowed ranges for alarm limits
- default values for breathing parameters
- allowed ranges for breathing parameters
- pressure and flow regulation
- scaling

The factory default values for the *Adult* and *Infant* patient categories may have been changed by a previous user.

Important: Always check the alarm settings after changing the patient category.

4.4.1 CHANGE THE PATIENT CATEGORY (OPTION)

To change the patient category during ventilation:

1. Press the *Menu* fixed key.
2. Press the *Change patient category* touchpad.
3. Press *Yes* to confirm OR,
4. Press *No* to cancel.

PROCEDURE DIAGRAM: CHANGE THE PATIENT CATEGORY DURING VENTILATION

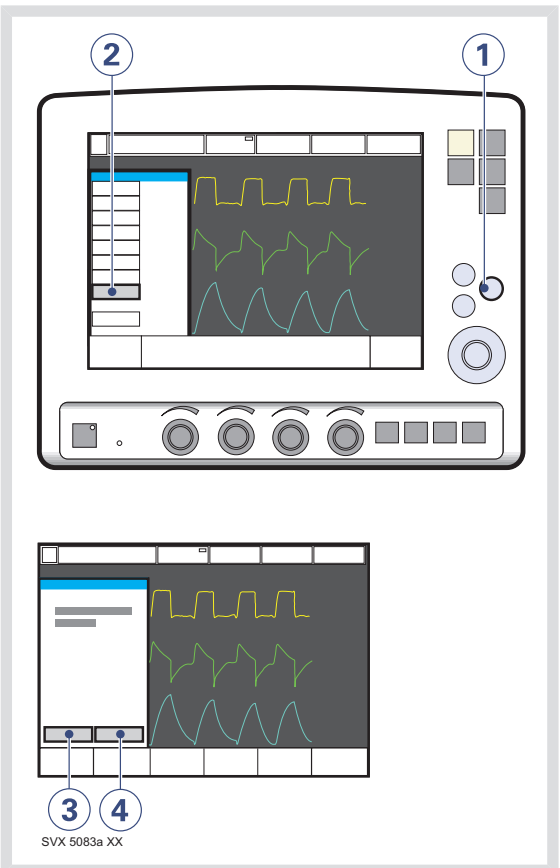

4.5 ENTER THE PATIENT DATA

1. Press the *Admit patient* touchpad.
2. Activate touchpads by turning and pressing the Main Rotary Dial or by pressing the appropriate touchpads.

Enter/edit the following characteristics:

3. Patient name
4. Identity number
5. Date of birth
6. Date of admission
7. Body height
8. Body weight
9. Press, for example, *Name* to enter the patient's name.
10. Press *Close keyboard* when entry is complete.
11. When the ID touchpad is pressed, a keypad appears in the window.
12. Press *Accept* to confirm new data.
13. Press *Cancel* to cancel new data.

PROCEDURE DIAGRAM: ENTER PATIENT DATA

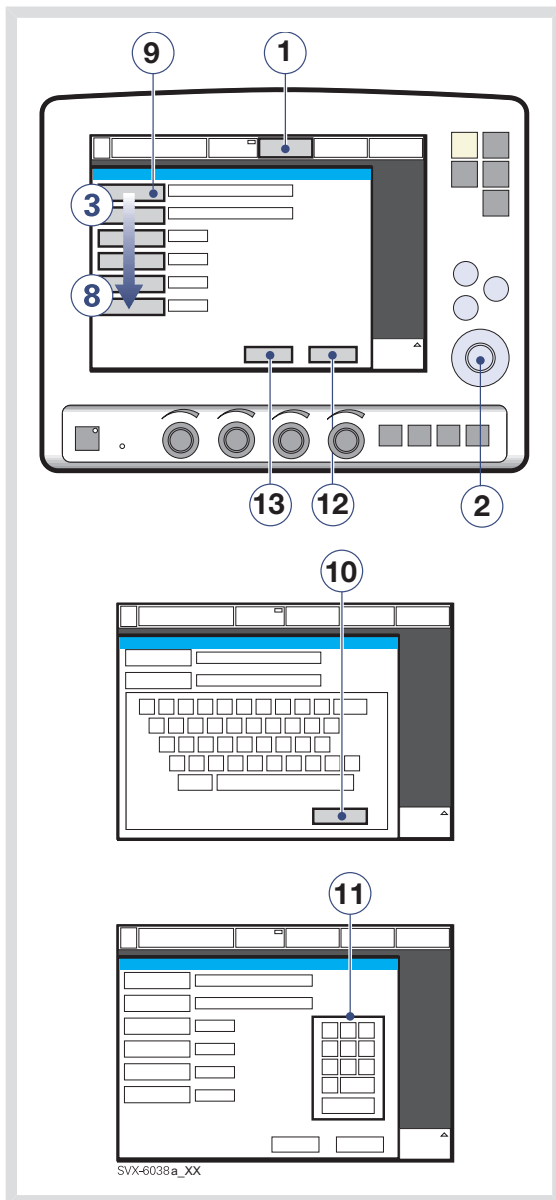

Important:

- *Adult* weights are in kilograms.
- *Infant* weights are in grams.
- Copy patient data before you enter a new name or ID, otherwise all data corresponding to the previous patient will be lost.
- The calculation of tidal and minute volume is based on entered body weight. If you omit this data, default values will be used for ventilation. An automatic calculation of Tidal Volume (based on body weight and immediately executed) will be performed only if the system is configured for *Tidal Volume based on body weight*.

4.6 SELECT THE TYPE OF VENTILATION (OPTIONS)

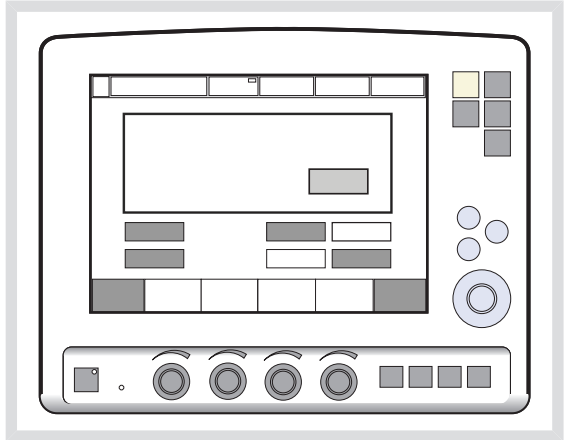

Press *Invasive ventilation* or *NIV (Non invasive ventilation)*.

Note: The default values may have been changed by a previous user.

4.7 SET VENTILATION MODE

To set ventilation mode and parameters:

1. Press the *Mode* touchpad.
2. Press the arrow at the active Mode pad. Available ventilation modes appear.
3. Press the touchpad for desired mode of ventilation.
4. If *Automode* is selected and the patient is triggering the ventilator, a green indicator mark will appear.

Note: Automode is not available in NIV.

5. When a ventilation mode has been selected, all related parameters can be set in the same window. Calculations are also displayed in this window.
6. Values are adjusted by turning the Main Rotary Dial.
7. Confirm each setting by pressing the parameter touchpad or pressing the Main Rotary Dial.
8. To activate all settings in the window press *Accept*, or to cancel the settings press *Cancel*.

PROCEDURE DIAGRAM: SET VENTILATION MODE

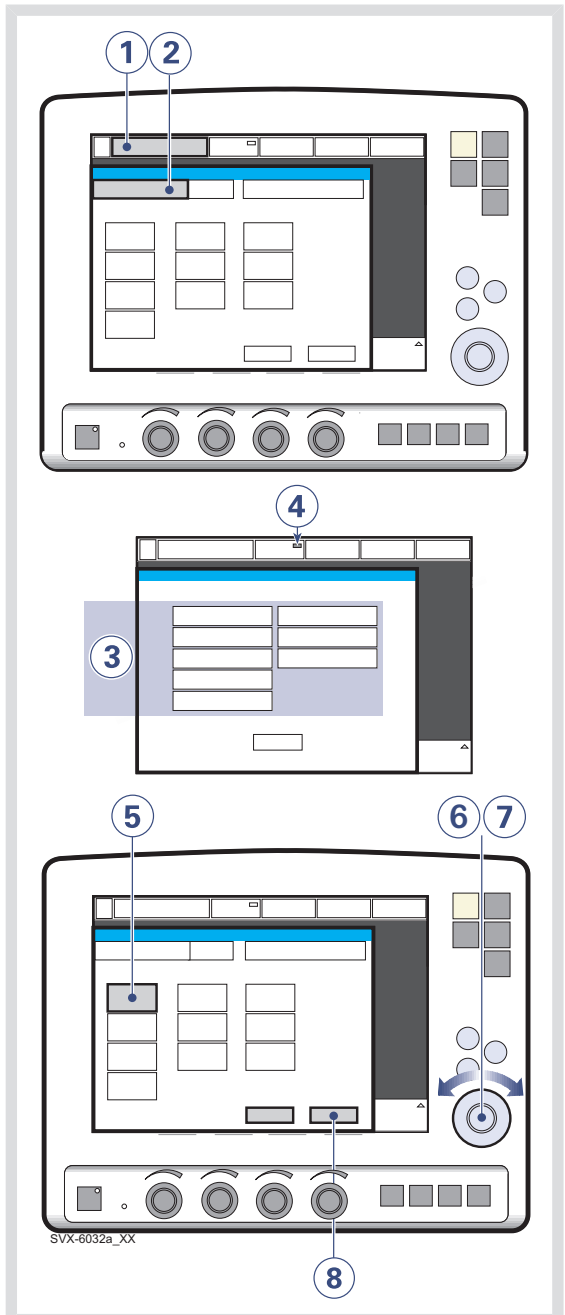

4.8 SET ALARM LIMITS

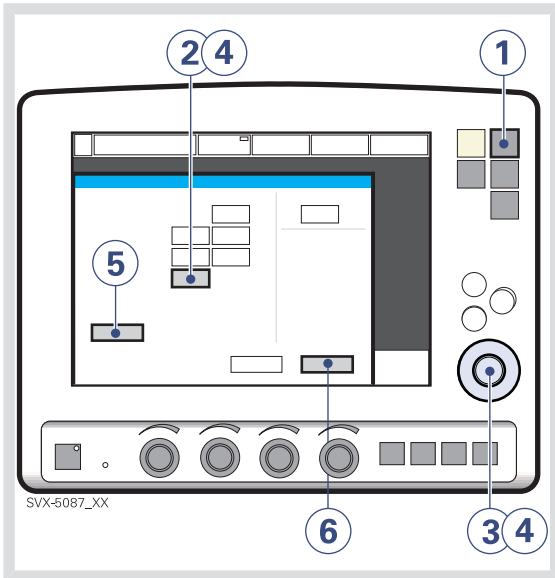

To set alarm limits:

1. Press the *Alarm Profile* fixed key.
2. Press the touchpad corresponding to the alarm limit you want to adjust or press the *Alarm sound level* touchpad.
3. Turn the Main Rotary Dial to adjust values.
4. Confirm each setting by pressing the parameter touchpad or Main Rotary Dial.

5. Press *Autoset*, if desired, to get a proposal for alarm limits in VC, PC, and PRVC modes.

Important: Before accepting *Autoset* values, make sure they are appropriate for the patient. If not, enter settings manually.

6. Press *Accept* to activate the new alarm limits.

Notes:

- *Autoset* is not possible in Standby because the ventilator requires patient values in order to propose alarm limits.
- *Autoset* is not available in supported or *NIV* (optional) modes.
- Current alarm limits are displayed during ventilation in smaller figures to the right of the parameter display.
- The Main Rotary Dial becomes inoperative for 2 seconds when a defined safety limit for the alarm limit being adjusted is reached. After this, it will be operable again.

4.9 START VENTILATION

The *Start/Standby* key is used to start and stop both invasive and non invasive ventilation. It is also possible in Standby to start ventilation by pressing the *Start ventilation* touchpad on the screen.

WARNING! Make sure that ventilation is started when a patient is connected to the ventilator. When the ventilator is in Standby, a flashing message, *Patient not ventilated*, is displayed as a reminder directly above the word Standby.

4.9.1 START INVASIVE VENTILATION

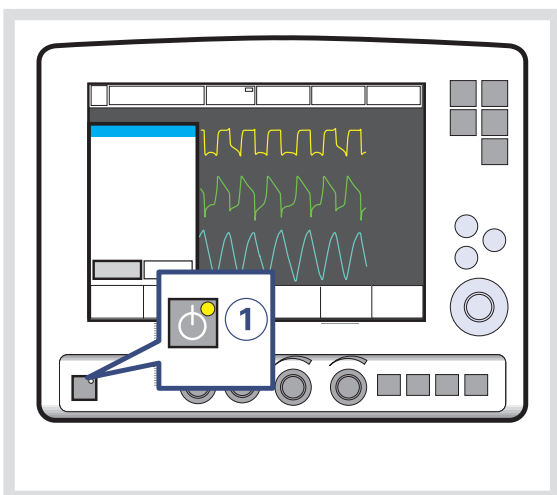

1. When the system is configured for invasive ventilation press the *Start/Standby* key (1) to start ventilation, or press the *Start ventilation* touchpad on the screen.

4.9.2 START NIV (NON INVASIVE VENTILATION) (OPTION)

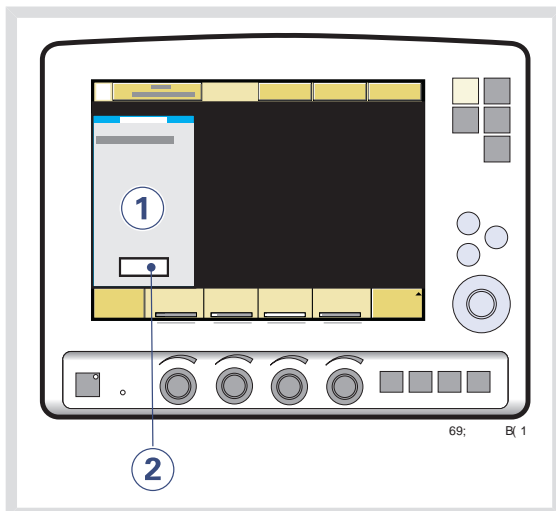

1. When the *Start/Standby* key is pressed and the SERVO-i Ventilator System is configured for NIV, a waiting position dialog is shown.

Note: All patient-related alarms are turned off for 120 seconds.

2. Press the *Start ventilation* touchpad.

Note: Ventilation starts automatically upon patient effort.

4.10 ADDITIONAL SETTINGS WINDOW

To adjust breathing parameters during ventilation, press the *Additional settings* touchpad to open the Additional Settings Window.

1. The *Additional settings* touchpad is in the lower left corner of the screen.
2. Values derived from settings such as inspiration time in seconds and calculated inspiratory flow are displayed.
3. A white bar indicates that the selected setting is within generally recognized safety limits.
4. A yellow (advisory) bar indicates that the selected setting is beyond generally recognized safety limits (this warning is accompanied by an audio signal and text message).
5. A red (warning) bar indicates that the selected setting is significantly beyond generally recognized safety limits (this warning is accompanied by an audio signal and text message).
6. Turning and pressing the Main Rotary Dial allows you to select settings and adjust values.

Note: New settings are effective from the first breath after adjustment (when the touchpad is deactivated).

7. The waveforms and measured values are displayed. Thus, the effects of the adjustments made can be checked immediately.
8. The *Close* touchpad closes the Additional Settings Window.

Note: The trigger sensitivity bar has different colors based on the setting. A green bar indicates a normal setting for flow triggering. The risk of self-triggering increases when the bar is red. A white bar indicates that pressure triggering is required.

THE ADDITIONAL SETTINGS WINDOW

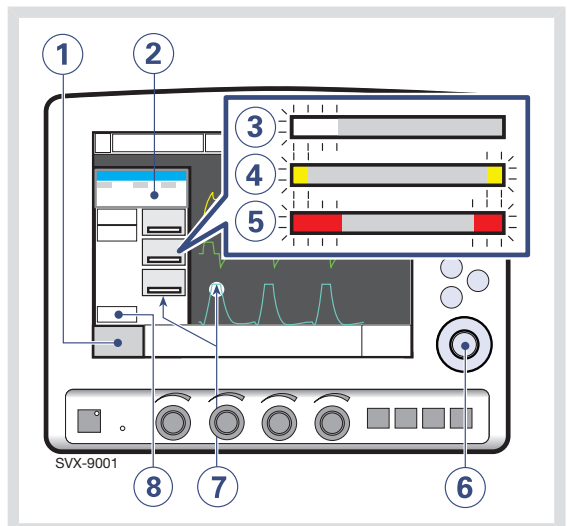

4.11 SUCTIONING

4.11.1 SUCTION SUPPORT

The Suction Support function makes it possible to automatically inhibit the ventilator from cycling during a tracheal suction procedure without activating alarms.

Suction Support includes:

- pre-oxygenation/preparation phase
- disconnect phase
- post-oxygenation phase

WARNINGS!

- Suction Support is not intended to be used together with closed-suction systems.
- The minimum PEEP level during suction support is 3 cmH₂O. The ventilator will adjust to the minimum level if the PEEP level is below 3 cmH₂O in order to detect disconnection of the patient.

Important: Alarms are turned off during the disconnect phase for a maximum of 60 seconds. If the patient has not been reconnected within 60 seconds, alarms are activated.

Notes:

- Suction Support is not available in NIV mode or when the *O₂ Breaths* function is activated.
- During the disconnect phase in Suction Support, the nebulizer is temporarily paused.
- When only one gas is connected, an elevated oxygen level cannot be set during the preparation phase. In this case, the post-oxygenation phase will be skipped.

PRE-OXYGENATION/PREPARATION PHASE

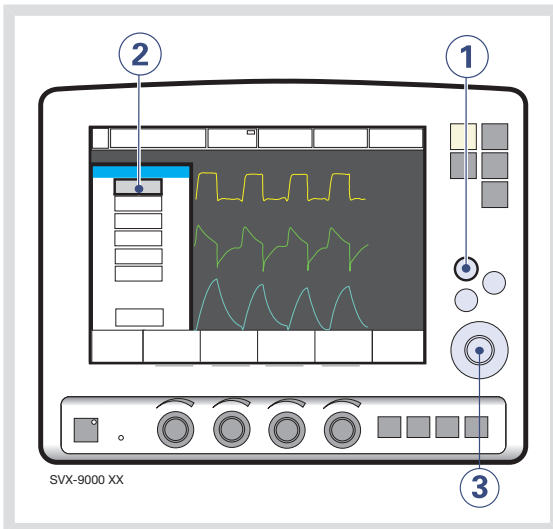

To enter the pre-oxygenation/preparation phase:

1. Press the *Quick access* fixed key.
2. Press the *Suction Support* touchpad.
3. Set the desired pre-oxygenation value by turning the Main Rotary Dial and press *Accept*.

Note: The *Cancel* touchpad will close the Suction Support program.

The *Check tubing* alarm is turned off: the maximum duration of the pre-oxygenation/preparation phase is 120 seconds. After 120 seconds, the system automatically returns to ventilation using the previous oxygen setting.

DISCONNECT PHASE

The system automatically enters the disconnect phase when the patient is disconnected during the pre-oxygenation/preparation phase.

During the disconnect phase the following alarms are turned off for up to 60 seconds:

- Apnea
- Minute volume
- Respiratory rate
- EtCO₂
- PEEP

When the patient is reconnected, the system automatically enters the post-oxygenation phase and restarts ventilation.

It is also possible to restart ventilation manually by pressing the *Start ventilation* touchpad.

POST-OXYGENATION PHASE

After reconnection, the ventilator will deliver the same oxygen concentration as in the preparation phase for 60 seconds.

After 60 seconds the system automatically returns to ventilation using the previous oxygen setting.

4.11.2 CLOSED-SUCTION SYSTEMS

If a closed-suction system is used, the Suction Support, Insp. hold and Exp. hold functions should **not** be used. Pressure-based modes (such as Pressure Control, Pressure Support, Bi-Vent/APRV, SIMV (PC) + PS, or NAVA) should be used. Settings should be adjusted to levels suitable for the patient. Hospital guidelines for suctioning should be followed.

4.12 RE-ADJUST THE OXYGEN CELL

Note: This does not apply if the SERVO-i Ventilator System has an O₂ sensor fitted.

If the ventilator has been in continuous use for an extended period, the measured O₂ concentration may drop due to normal degradation of the oxygen cell. In order to avoid nuisance alarms in this situation, it is possible to temporarily adjust the O₂ cell during ventilation.

When the *O₂ cell adaptation* function is activated, the oxygen cell is re-adjusted so that the current measured O₂ concentration is equal to the O₂ concentration set by the user. This temporary adjustment will be valid until the ventilator is switched off.

Important: Before using the SERVO-i Ventilator System, always perform a Pre-use check to make sure the O₂ cell is properly calibrated.

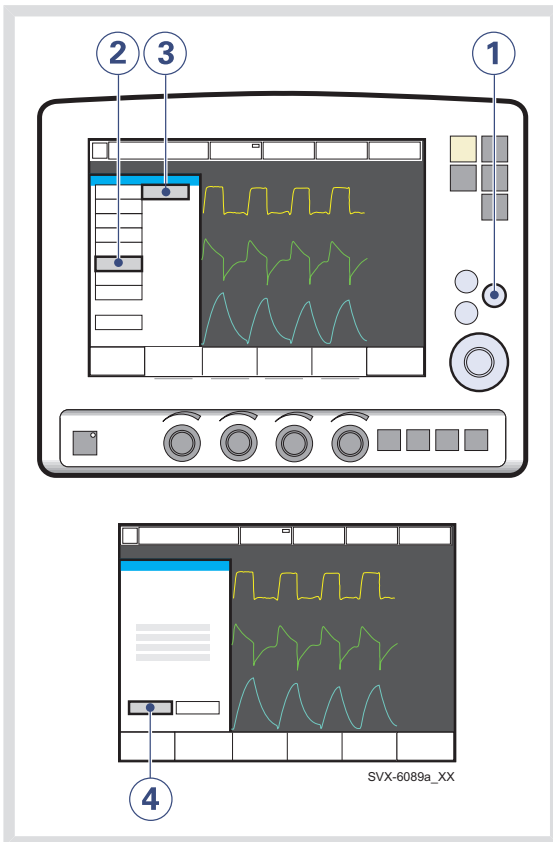

4.13 DISCONNECT THE PATIENT

To disconnect and stop ventilation:

1. Physically disconnect the patient from the ventilator.
2. Press the *Start/Standby* key.
3. Press *Yes* to stop ventilation.
4. Turn the ventilator off using the *On/Off* switch behind the User Interface.

To re-adjust the O_2 cell:

1. Press the *Menu* fixed key.
2. Press the *Biomed* touchpad.
3. Press the *O_2 cell adaptation* touchpad.
4. Press the *Yes* touchpad to perform the O_2 cell adaptation.

5 MONITOR AND RECORD

TABLE OF CONTENTS

5.1	Measured values display		64
5.2	Waveform display		66
5.3	Show loops		69
5.4	Show trends		70
5.5	Show event log		70
5.6	Save data		71

5.1 MEASURED VALUES DISPLAY

During ventilation, measured or calculated values of breathing parameters are displayed. This section describes the display, gives the procedure for displaying additional pages of measured and calculated values, and lists all viewable values.

5.1.1 DESCRIPTION

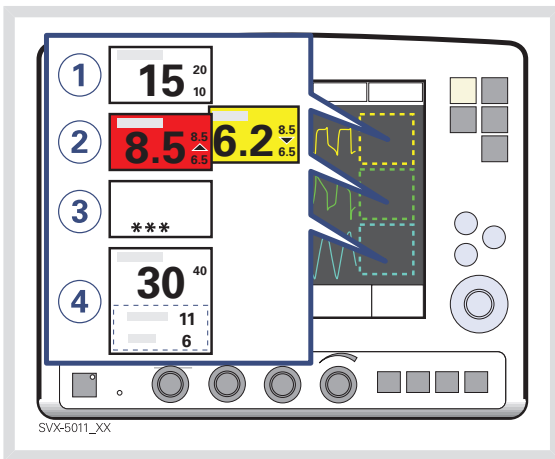

Breathing parameter values are displayed on the right side of the screen.

1. Alarm limits are displayed in small digits.
2. An up or down arrow indicates whether the upper or lower alarm limit has been exceeded.
 - If a high priority alarm limit is exceeded, the box turns red.
 - If a medium priority alarm limit is exceeded, the box turns yellow.
3. Off-scale values are indicated by ***.
4. It is possible to change which values are displayed in the measured value boxes. (See Configuration chapter)

5.1.2 DISPLAY ADDITIONAL PAGES

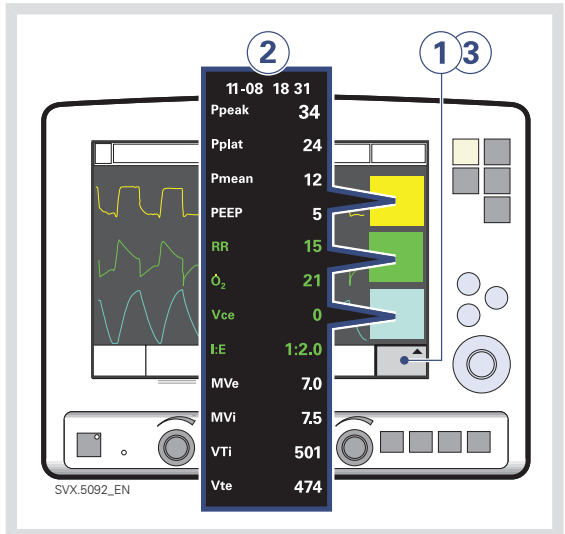

To view more values:

1. Press the *Additional values* touchpad in the lower right corner of the screen.
2. View desired values.
3. Press the *Additional values* touchpad again to view the next page of values.

Notes:

- In NIV mode there is only one page of additional values.
- In Nasal CPAP mode no additional values are available.

5.1.3 VALUES LIST

Values in boldface are shown on the first page by default.

Ppeak	Maximum inspiratory pressure
Pplat	Pressure during end-inspiratory pause
Pmean	Mean airway pressure
PEEP	Positive end expiratory pressure
PEEP _{tot}	Set PEEP + Intrinsic PEEP
CPAP	Continuous Positive Airway Pressure (Nasal CPAP only)
RR	Respiratory Rate
O₂	Measured oxygen concentration in vol. %
Ti	Inspiration time
Tc	Time constant
I:E	Inspiration to expiration ratio (during controlled ventilation)
Ti/Ttot	Duty cycle or ratio of inspiration time to total breathing cycle time (during spontaneous breathing and Bi-Vent/APRV).
MVe	Expiratory Minute Volume
MVi	Inspiratory Minute Volume
MVe sp	Spontaneous expiratory minute volume (Bi-Vent/APRV)
MVe sp / MVe	The relation between spontaneous expired minute volume and total expired minute volume (Bi-Vent/APRV).
Leakage	Leakage % (NIV)
VTi	Inspiratory Tidal Volume
VTe	Expiratory Tidal Volume
V_{ee}	End expiratory flow
etCO₂	End tidal carbon dioxide concentration (CO ₂ Analyzer - option)
V_{CO₂}	Volume of expired CO ₂ per minute (CO ₂ Analyzer - option)
VTCO₂	CO ₂ tidal elimination (CO ₂ Analyzer - option)
Cdyn	Dynamic characteristics
SI	Stress Index
Cstatic	Static compliance, respiratory system
E	Elastance
Ri	Inspiratory resistance
Re	Expiratory resistance
WOB v	Work of breathing, ventilator
WOB p	Work of breathing, patient

P0.1	Indicator for respiratory drive
SBI	Shallow Breathing Index

5.2 WAVEFORM DISPLAY

The following color-coded waveforms are shown on the user interface screen by default:

- pressure time
- flow time
- volume time

If the optional Edi module and CO₂ Analyzer are connected, the following color-coded waveforms are shown:

- pressure time
- flow time
- Edi time
- CO₂ concentration time

This section describes the waveform display, and the procedures for hiding/displaying the volume, Edi and CO₂ waveforms and for adjusting the sweep speed and scale of the waveforms.

5.2.1 DESCRIPTION

The default waveform display has the following characteristics:

- The value of a measured parameter vs. time is displayed.
- The displayed parameter and the scale are indicated on the y-axis.
- The pressure vs. time display is dark yellow.
- The flow vs. time display is green.
- The volume vs. time display is light blue.
- The Edi signal vs. time display is light green.
- The CO₂ concentration vs. time display is light yellow.

5.2.2 SHOW AND HIDE

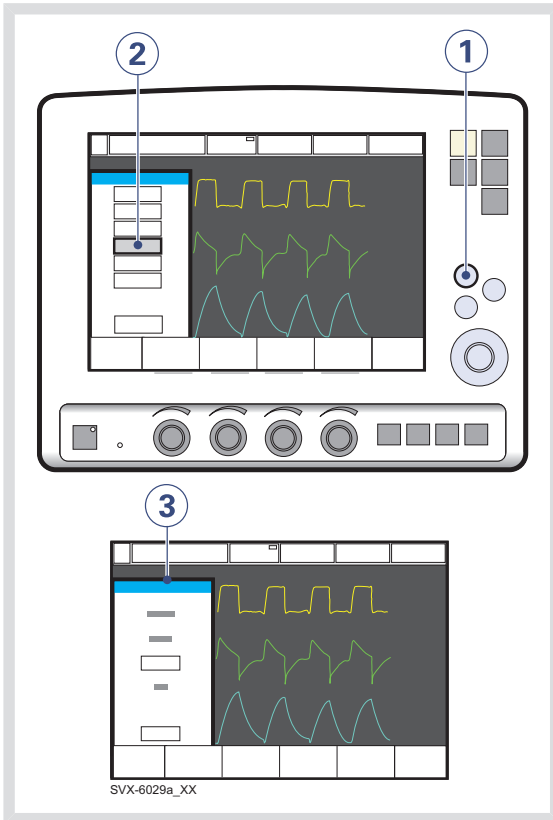

To show or hide the volume, Edi or the CO₂ waveform display:

1. Press the *Quick access* fixed key.
2. Press the *Waveform configuration* touchpad.
3. Press the touchpad corresponding to the waveform you wish to show or hide.

Notes:

- The pressure waveform and the flow waveform are always displayed. The volume, Edi and CO₂ waveforms may be hidden. Thus, 2, 3, or 4 waveforms may be displayed.
- When you hide a waveform, the remaining waveforms are expanded to use all available screen space.

5.2.3 ADJUST SCALE/SWEEP SPEED

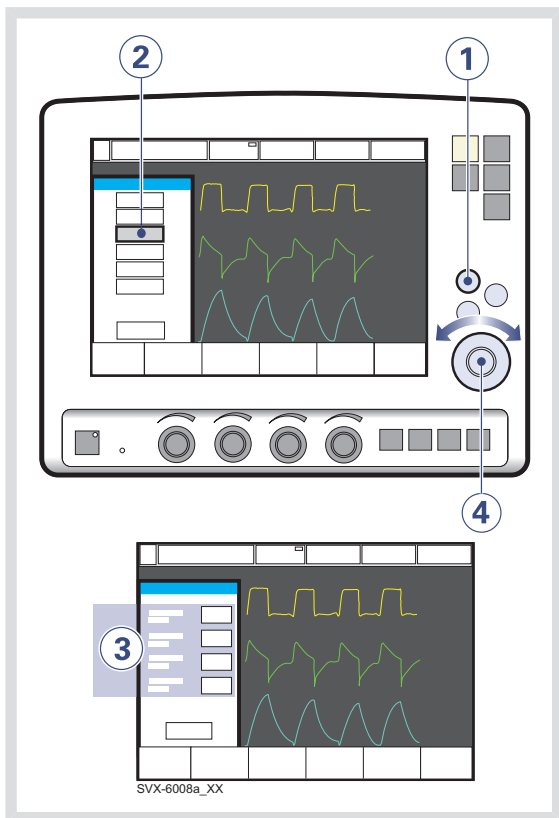

To set the sweep speed and amplitude for displayed waveforms:

1. Press the *Quick access* fixed key.
2. Press the *Waveform Scales* touchpad.
3. Press the touchpad corresponding to the waveform whose scale you wish to change or select a sweep speed (5, 10 or 20 mm/s).
4. To adjust the scale of a waveform, turn the Main Rotary Dial to the desired value or use auto scale (press *Auto*).



Important: MAQUET does not recommend using auto scale in Bi-Vent/APRV mode, when patient breathing is spontaneous on both levels.

5.3 SHOW LOOPS

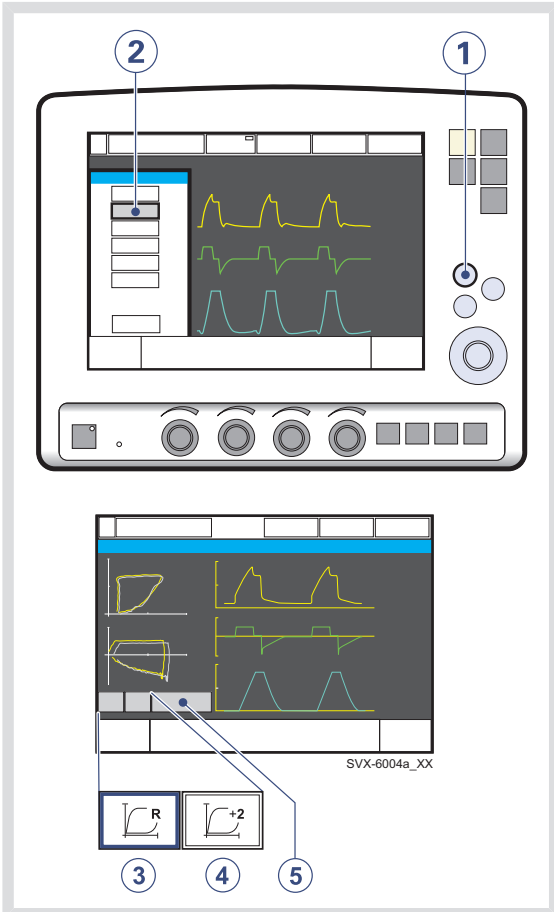
The Loops function provides a graphical representation of the relationship between flow-volume and pressure-volume.



To activate the Loops function:

1. Press the *Quick access* fixed key.
2. Press the *Loops* touchpad
3. Press  [reference loop] to store a reference loop.
4. Press  [overlay loops] to see the two previous loops simultaneously.
5. To close the window, press *Close*.

5.4 SHOW TRENDS

Trend values are stored every 60 seconds and retained as far back as 24 hours. Stored events and system changes are shown as event stamps.

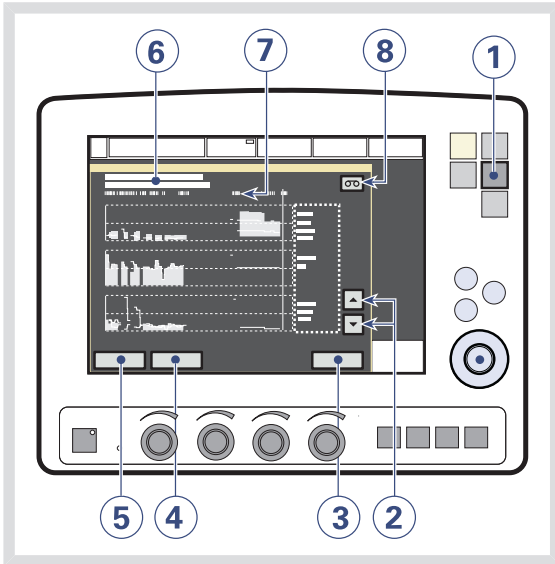

To show trends:

1. Press the *Trends* fixed key.
2. Use the up and down arrows to scroll between the different trend channels.
3. To quit the Trends Window press *Close*.
4. To adjust the time resolution press the *Hours* touchpad and turn the Main Rotary Dial.
5. Activate the *Cursor*. Move it back and forth on the time axis using the Main Rotary Dial or touch screen.
6. Time valid for the cursor position. For event stamps, an explanation appears.
7. Logged event stamps.

8. If a recording is saved at a time corresponding to the cursor position, a recording button is shown. To view the recording, press the button.

5.5 SHOW EVENT LOG

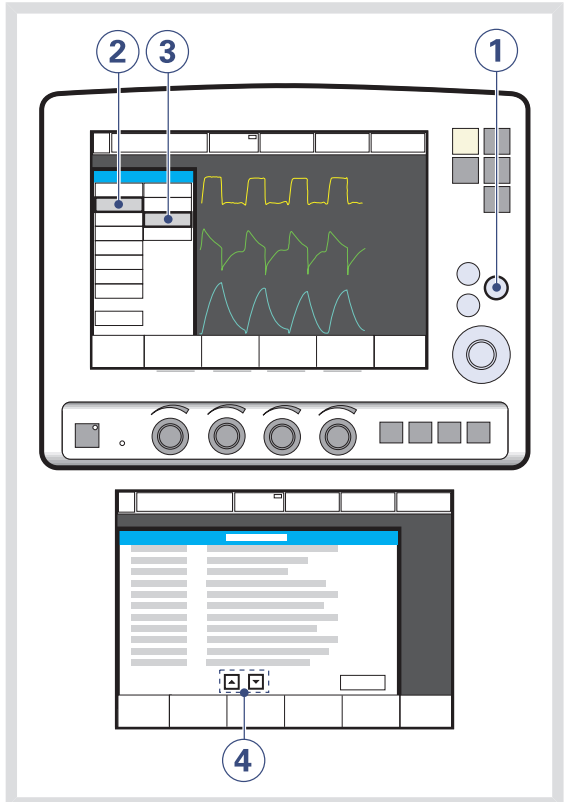

To view the Event Log:

1. Press the *Menu* fixed key.
2. Press the *Review* touchpad.
3. Press the *Event log* touchpad to view all logged events.
4. Use the arrows to scroll.

5.6 SAVE DATA

Waveforms and settings may be saved in the following ways:

- A 20-second recording may be taken for immediate on-screen analysis.
- Screen data or patient data may be written to an Ventilation Record Card (option) for later analysis (patient data file is readable by Microsoft Excel).

5.6.1 RECORD WAVEFORMS

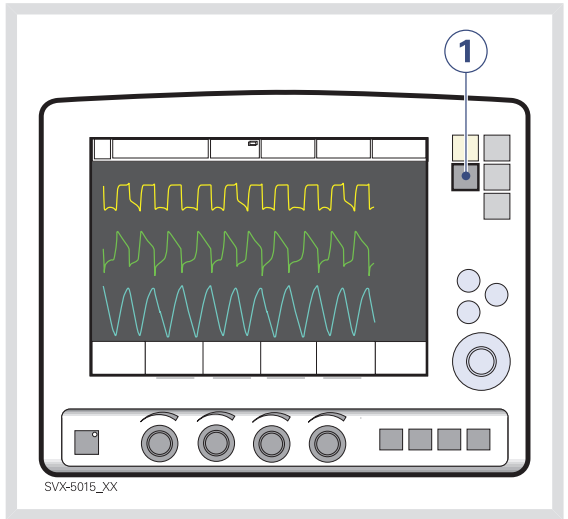

1. Press the Save fixed key.

To save one recording of the current waveform along with breathing parameter values:

A total of 20 seconds of data will be recorded: 10 seconds before the Save key was pressed and 10 seconds after the Save key was pressed.

Note: If Save is pressed again, the previous recording will be erased. Using *Admit patient* also erases the previous recording.

5.6.2 VIEW RECORDED WAVEFORMS.

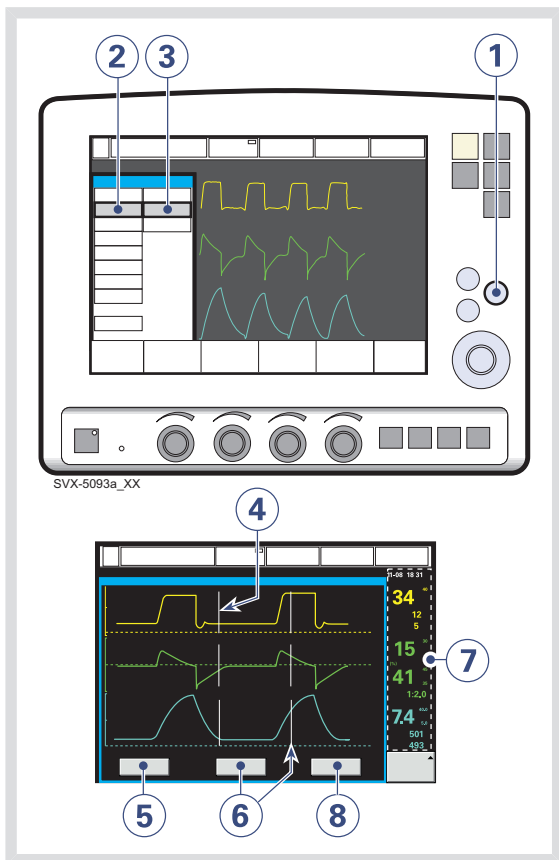

To view the data in a recorded waveform:

1. Press the *Menu* fixed key.
2. Press the *Review* touchpad.
3. Press the *Recorded waveform* touchpad.
4. Vertical gray lines indicate the time when the *Save* key was pressed.
5. Press the *Settings* touchpad to open the list of parameter settings in use at the time the *Save* key was activated.
6. Press the *Cursor* touchpad to activate the cursor. Move the cursor using the *Main Rotary Dial*.
7. View measured/calculated values next to the vertical gray lines.
8. Press *Close* to quit the *Recorded Waveform Window*.

5.6.3 VENTILATION RECORD CARD (OPTION)

The Ventilation Record Card (VRC) can be used in Standby or during ventilation. The following data can be saved for analysis:

- screen data
- patient data

Important: Always handle the VRC and its contents in accordance with regulations and hospital routines.

Please refer to the Ventilation Record Card User's Manual.

Copy Screen Data to a Ventilation Record Card

To make a copy of the screen, the Save key must be configured. It is possible to copy multiple data sets to the same Ventilation Record Card.

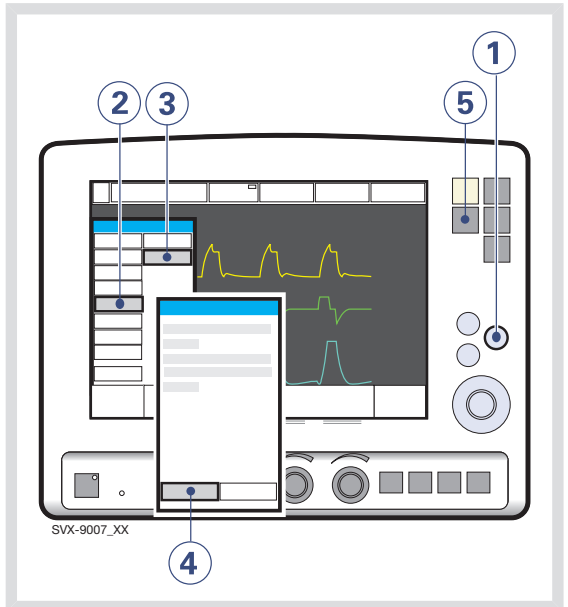

1. Press the *Menu* fixed key.
2. Press the *Copy* touchpad.
3. Press the *Copy screen* touchpad.
4. Insert the VRC and press *OK* to continue.
5. Press the *Save* fixed key.

A copy of the screen is stored on the VRC.

Notes:

- To make another screen copy, press the *Save* key again.
- When the VRC is removed or the ventilator is restarted, the *Save* key is automatically reconfigured to save a recording.

Copy Patient Data to a Ventilation Record Card

The following patient data may be copied to a VRC:

- Event log
- Trends
- Recordings
- Open Lung Tool® data
- Neuro Ventilatory Tool data

Included in all data files are:

- Patient name and ID
- Ventilator serial number
- Pre-use check status.

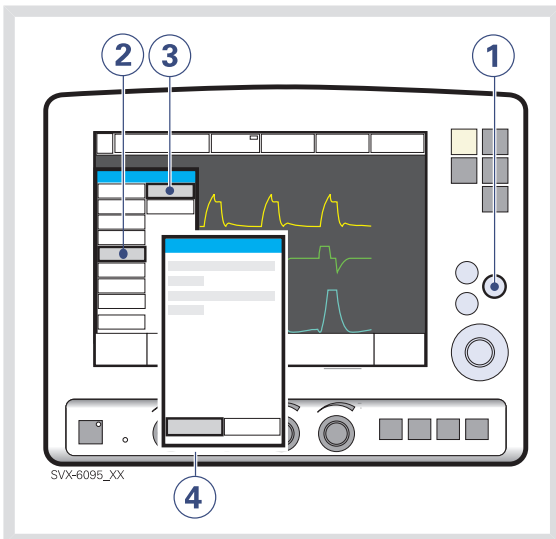

To copy patient data to a VRC:

1. Press the *Menu* fixed key.
2. Press the *Copy* touchpad.
3. Press the *Copy data* touchpad.
4. Insert the VRC.
5. Press the *Copy data* touchpad.

Remove the VRC when copying is complete.

6 VENTILATION, MODES AND FUNCTIONS

TABLE OF CONTENTS

6.1	Introduction	76
6.2	Important definitions	78
6.3	Settings	80
6.4	Volume Control	86
6.5	Pressure Control	91
6.6	Pressure Regulated Volume Control	94
6.7	Volume Support	97
6.8	Pressure Support	100
6.9	Spontaneous/CPAP	103
6.10	Automode	105
6.11	SIMV	109
6.12	Bi-Vent/APRV	118
6.13	Non Invasive Ventilation	121
6.14	Nasal CPAP (Infant only)	125
6.15	Backup ventilation	127
6.16	Ventilatory parameters - overview	131
6.17	Special functions	134
6.18	Open Lung Tool	137
6.19	Stress Index	140
6.20	Heliox	143

6.1 INTRODUCTION

The SERVO-i Ventilator System can operate in several different modes. This chapter describes the modes, their settings, and associated safety information.

It also summarizes special ventilatory functions, backup ventilation, and breathing parameters.

See the Technical data chapter for default values and allowed ranges for the breathing parameters.

Note:

The SERVO-i Ventilator System is delivered preset with the following configuration options:

- Breathing parameters are based on either Minute Volume or Tidal Volume.
- Breathing parameters are based on either I:E Ratio or Inspiration Time.

6.1.1 WARNINGS

Note: Not all warnings apply to all modes.

WARNINGS!

- Be sure to set alarm limits as appropriate for each mode, especially:
 - Minute Volume Alarm
 - Apnea time
- Self-triggering should be avoided. Do not set the trigger sensitivity too high.
- To protect the patient's lungs from excessive pressure it is important to set the upper pressure limit to a suitable value.

- The following warnings apply to Non Invasive Ventilation (NIV) only:
 - Avoid high inspiratory pressure as it may lead to gastric overdistention and risk of aspiration. It may also cause excessive leakage.
 - Use of the Nebulizer is not recommended.
 - We recommend ventilator-independent monitoring for Nasal CPAP.
- Ensure that PRVC, SIMV (PRVC) and VS function properly (especially for small patients):
 - Avoid leakage (e.g. due to an uncuffed endotracheal tube).
 - If compliance compensation is used, make sure that the compressible volume of the patient circuit is **not** changed after the Pre-use check / Patient Circuit Test has been performed (e.g. filling an active humidifier with water after the test has been made).

6.1.2 APPLICATION

The SERVO-i Ventilator System also contains tools to assist the user in application of lung protective methodologies.

When required, all ventilation is provided for mandatorily. When the patient is able to initiate a breath, the ventilator supports and monitors the patient's breathing capability and controls ventilation only if required.

6.1.3 SCOPE - VENTILATORY NEEDS

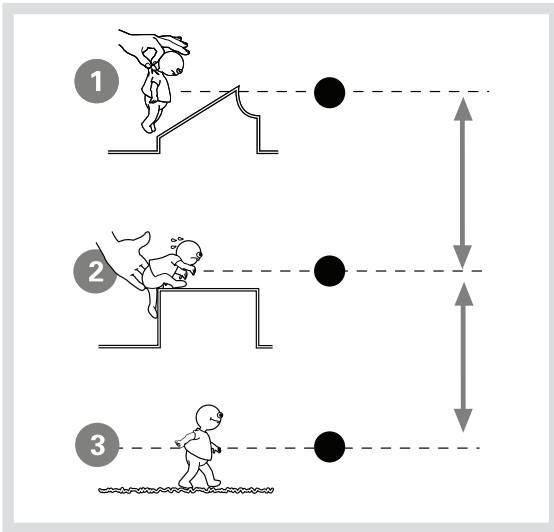

The ventilator can be used for:

1. controlled ventilation
2. supported ventilation, or
3. spontaneous breathing/CPAP

It also allows for combined ventilatory control or support. Spontaneous breathing efforts are sensed during controlled ventilation, e.g. Volume Control. Mandatory ventilation can be used during supported/spontaneous breathing, e.g. the enhanced SIMV functionality.

The Automode functionality continuously adapts to the patient's breathing capability.

6.2 IMPORTANT DEFINITIONS

The graphic display of pressure, flow and volume is visualized in waveforms. Modes of ventilation directly affect flow, pressure and volume patterns.

6.2.1 VOLUME CONTROL

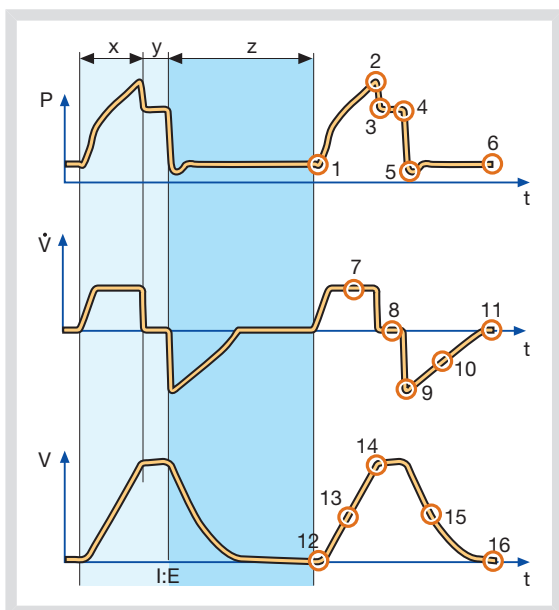

X. Inspiration time

Y. Pause time

Z. Expiration time

PRESSURE-TIME WAVEFORM

1. Start of Inspiration
2. Peak inspiratory pressure
3. Early inspiratory pause pressure
4. End inspiratory pause pressure
5. Early expiratory pressure
6. End expiratory pressure

FLOW-TIME WAVEFORM

7. Peak inspiratory flow
8. Zero flow phase
9. Peak expiratory flow
10. Slope decelerating expiratory limb
11. End expiratory flow

VOLUME-TIME WAVEFORM

12. Start of inspiration
13. The slope represents current delivery of inspiratory tidal volume
14. End inspiration
15. The slope represents current patient delivery of expiratory tidal volume
16. End expiration

6.2.2 PRESSURE CONTROL

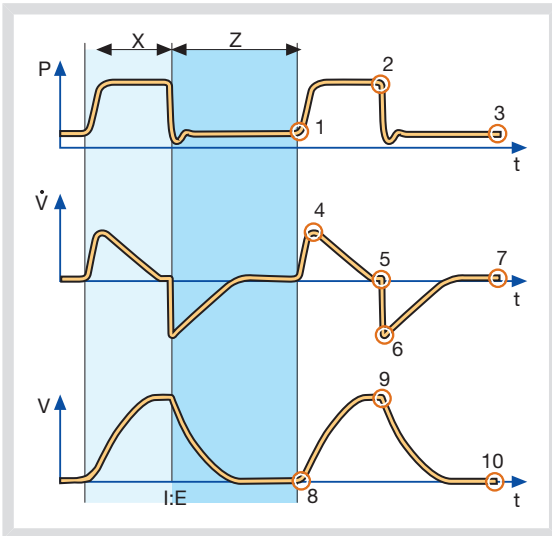

8. Start of inspiration

9. End inspiration

10. End expiration

X. Inspiration time

Z. Expiration time

PRESSURE-TIME WAVEFORM

1. Start of Inspiration

2. Peak inspiratory pressure

3. End expiratory pressure

FLOW-TIME WAVEFORM

4. Peak inspiratory flow

5. End inspiratory flow

6. Peak expiratory flow

7. End expiratory flow

6.3 SETTINGS

6.3.1 TRIGGER FUNCTIONALITY

Trigger sensitivity determines the level of patient effort needed to trigger the ventilator to inspiration.

Trigger sensitivity can be set as flow triggering (settings above zero) or pressure triggering (settings below zero). Normally flow triggering is preferable as this enables the patient to breathe with less effort.

The sensitivity is set as high as possible without self-triggering. This ensures that triggering is patient initiated and avoids auto-cycling by the ventilator.

Important: In NIV it is not possible to set trigger sensitivity.

- The trigger sensitivity bar has different colors based on the setting. A green bar indicates a normal setting for flow triggering. The risk of self-triggering increases when the bar is red. A white bar indicates pressure triggering.
- If the trigger sensitivity is set too high, a self triggering (auto-triggering) condition may be reached. This condition can also be reached if there is leakage in the breathing system, e.g. if an uncuffed endotracheal tube is used. Triggering will then be initiated by the system and not by the patient. This should always be avoided by decreasing the trigger sensitivity.

During expiration, the ventilator continuously delivers a gas flow (bias flow), which is measured in the expiratory channel. For details of the bias flow, see Technical data on page 224.

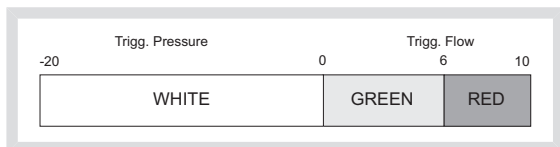

At a trigger sensitivity level above zero (0), The ventilator senses deviations in the bias flow delivered during expiration. These deviations are caused by the inspiratory efforts of the patient. The further to the right on the scale, the more sensitive is the trigger function.

At a trigger sensitivity level below zero (0), the ventilator senses deviations in the pressure below PEEP created by the patient. The pressure below PEEP required to initiate a breath is shown when the setting is made. The further to the left on the scale, the more effort is required to trigger.

6.3.2 INSPIRATORY RISE TIME

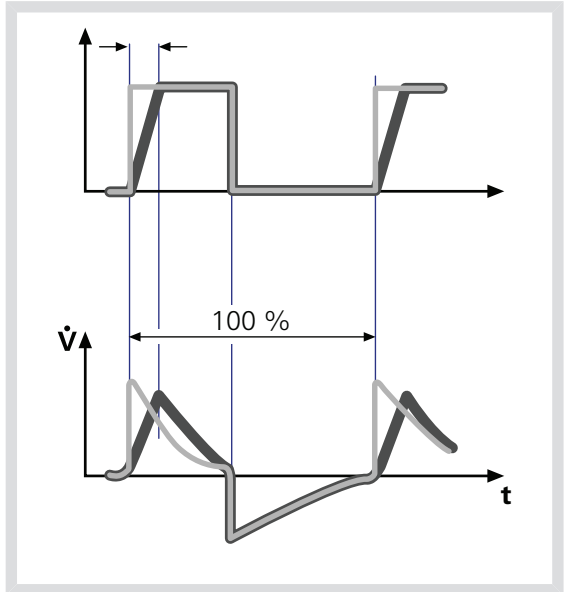

Time to peak inspiratory flow or pressure at the start of each breath as a percentage of the respiratory cycle time or in seconds. Increased rise time will affect the rate of flow/pressure increase and can be evaluated by the shape of the flow and pressure waveforms.

Inspiratory rise time (%) is applicable in Pressure Control, Volume Control, PRVC, SIMV-Volume Control, SIMV-Pressure Control, SIMV-PRVC. Setting can be in the range 0-20% of the respiratory cycle time.

Inspiratory rise time set in seconds is applicable in Pressure Support, Volume Support and Bi-Vent/APRV. For adults the range is 0-0.4 seconds and for infants the range is 0-0.2 seconds.

Note: When the ventilator is configured for setting of Inspiration time, the unit for Inspiratory rise time then automatically switches to seconds for all ventilation modes.

Normally in supported modes the Inspiratory rise time should be increased from the default setting and to give more comfort to the patient.

6.3.3 TRIGGER TIMEOUT

Trigger Timeout is the maximum allowed apnea time in Automode before controlled ventilation is activated.

Initially the ventilator adapts with a dynamic Trigger Timeout limit. This means that for the spontaneously triggering patient the timeout increases successively during the first ten breaths.

For Automode trigger timeout setting ranges, see section Breathing parameters on page 228.

6.3.4 PEEP

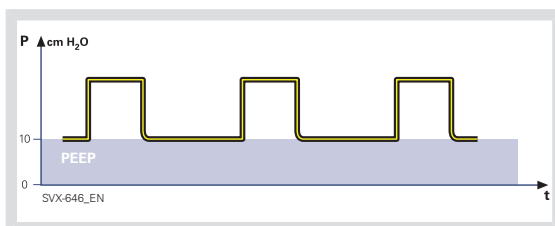

A Positive End Expiratory Pressure is maintained in the alveoli and may prevent the collapse of the airways.

For Positive End Expiratory Pressure setting ranges, see section Breathing parameters on page 229

6.3.5 I:E RATIO / INSPIRATION TIME

The setting of breathing parameters in SERVO-i Ventilator System can be configured in two different ways, based on:

- I:E ratio (independent of changes of e.g. the breathing frequency) or,
- Inspiration time in seconds (independent of changes of e.g. the breathing frequency), to better meet the requirements for infant care.

When the ventilator is configured for setting of Inspiration time, the unit for Pause time and Insp. rise time then automatically switches to seconds. The resulting I:E ratio for each setting is shown in the upper right information area of the ventilation mode window.

As the inspiration time is explicitly set, a change of for example the Respiratory Rate will affect the I:E ratio. As a safety precaution, it will therefore be indicated when the resulting I:E ratio passes 1:1 in either direction.

Note: The touchpad Breath cycle time is not shown when an SIMV mode is selected, since there is no need to set Breath cycle time when Inspiration time is directly set.

6.3.6 INSPIRATORY CYCLE-OFF

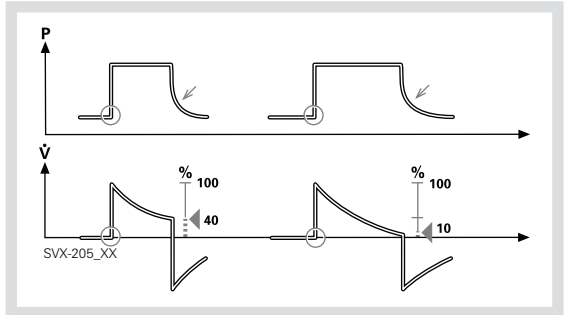

Inspiratory Cycle-off is the point at which inspiration changes to expiration in spontaneous and supported modes of ventilation. A decrease of the inspiratory flow to a preset level causes the ventilator to switch to expiration. This preset level is measured as a percentage of the maximum flow during inspiration.

For inspiratory cycle off setting ranges, see section Breathing parameters on page 228.

6.3.7 BREATH CYCLE TIME

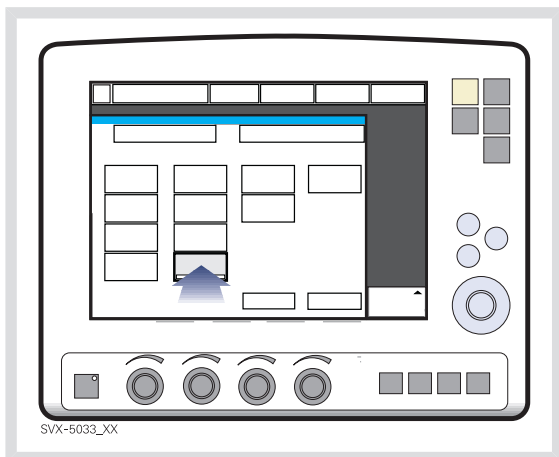

This is the length of the breath i.e. the total cycle time of the mandatory breath in SIMV (inspiration, pause plus expiration).

Note: The touchpad Breath cycle time is not shown when an SIMV mode is selected and inspiration time is configured. Refer to heading I:E ratio / Inspiration times.

6.3.8 VOLUME SETTING

Depending on the ventilator configuration the inspiratory volume can be set as:

- Minute Volume or,
- Tidal Volume

6.3.9 CONTROLLED / SUPPORTED PRESSURE LEVEL

PC (Pressure Control level) above PEEP is the set inspiratory pressure level for each mandatory breath in Pressure Control and SIMV (PC) + PS, and also for backup ventilation in Pressure Support and NAVA.

PS (Pressure Support level) above PEEP is the set inspiratory pressure support level for triggered breaths in Pressure Support, SIMV modes and Bi-Vent/APRV.

6.3.10 O₂ CONCENTRATION

The setting range for the oxygen concentration is 21% O₂ to 100% O₂. The alarm limits are automatically set at approximately 5% O₂ above or below the set concentration value. The alarm is delayed 40 seconds after changing the O₂ concentration setting. There is also an absolute minimum alarm limit of 18% O₂ which is independent of operating settings.

6.3.11 RESPIRATORY RATE / SIMV RATE

Respiratory rate is the number of controlled mandatory breaths per minute in controlled modes excluding SIMV. The respiratory rate is also used for calculation of tidal volume if the ventilator is configured for Minute volume setting. SIMV rate is the number of controlled mandatory breaths in SIMV modes.

6.3.12 PREVIOUS MODE

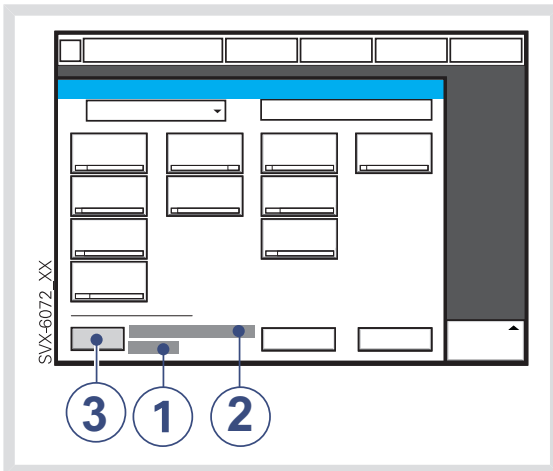

1. Time when previous mode was inactivated.
2. Name of the previous mode.
3. Press the touchpad Show previous mode to recall the previous accepted ventilation mode.

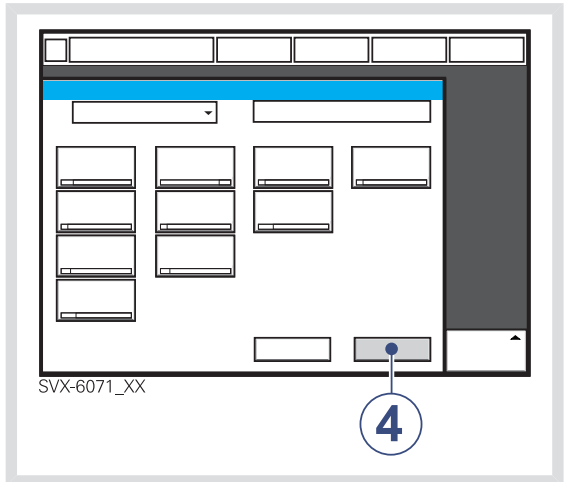

4. Activate the previous used ventilation mode settings by pressing the Accept touchpad.

Notes:

- The previous mode function is not available after a Pre-use check, changing of patient category, admitting a new patient, use of the same ventilation mode for more than 24 hours or after restarting the system.
- When *Previous Mode* is activated during Backup ventilation, the ventilator returns to the mode that was active before Support mode was initiated.
- A recall of previous settings is only possible after a change of ventilation mode.

6.4 VOLUME CONTROL

6.4.1 FUNCTIONAL DESCRIPTION VOLUME CONTROL

In the flow/volume oriented modes a controlled flow is used to maintain the set inspiratory Tidal Volume.

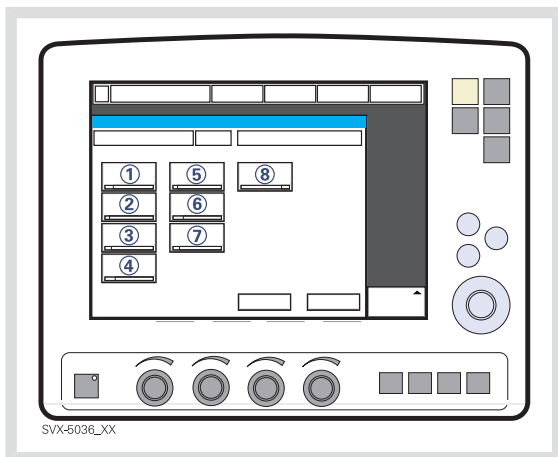

Volume Controlled ventilation ensures that the patient receives a certain pre-set Minute/Tidal Volume.

The SERVO-i Ventilator System can be configured to set Tidal Volume or Minute Volume. The following parameters are set:

1. Tidal Volume (ml) or the Minute Volume (l/min)
2. Respiratory Rate (b/min)
3. PEEP (cmH₂O)
4. Oxygen concentration (%)
5. I:E ratio / Insp. time
6. Pause time (%/s)
7. Inspiratory rise time (%/s)
8. Trigg. Flow / Trigg. Pressure

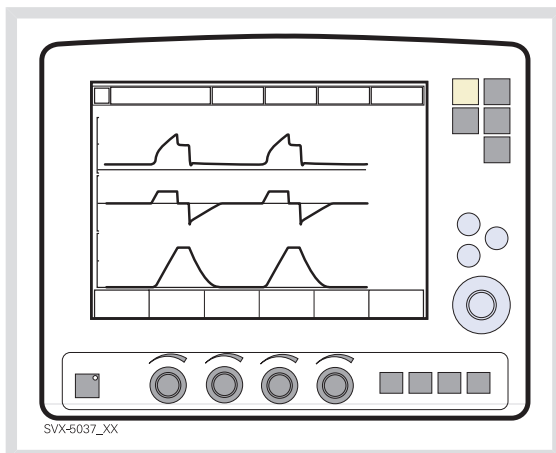

The airway pressure is dependent on the tidal volume, inspiration time and the resistance and compliance of the respiratory system. The set tidal volume will always be delivered. An increase in the resistance and decrease in compliance will lead to an increased airway pressure. To protect the patient's lungs from excessive pressure, it is very important to set the upper pressure limit to a suitable value.

6.4.2 FLOW ADAPTATION

It is possible for the patient to trigger extra breaths if they can overcome the pre-set trigger sensitivity. It is also possible for the patient, by their own inspiratory efforts, to receive a higher inspiratory flow and Tidal Volume during an inspiration than pre-set. The flow during inspiration is constant. The patient can trigger extra breaths.

Volume Controlled ventilation has, by tradition, delivered each breath with a constant flow and constant inspiratory and expiratory times, according to the settings. The SERVO-i Ventilator System gives the possibility to the patient to modify both flow rate and timing. So, if a pressure drop of 3 cmH₂O is detected during inspiration, the ventilator cycles to Pressure Support with a resulting increase in inspiratory flow. When the flow decreases to the calculated target level this flow will be maintained until the set Tidal Volume is delivered.

The illustrated waveform show some practical consequences of this enhanced functionality.

- the top waveform shows the trace for a normal Volume Controlled breath
- the second waveform shows a situation when inspiration is prematurely interrupted as the set tidal volume has been delivered
- the third waveform shows a situation where the patient maintains a flow rate higher than the calculated target value. The set Tidal Volume has been delivered when calculated target flow is reached and the inspiration is prematurely interrupted
- the bottom waveform, shows a situation where the increased flow rate is maintained into the expiratory period. The patient will receive a higher tidal volume than set due to a higher flow/volume demand than calculated.

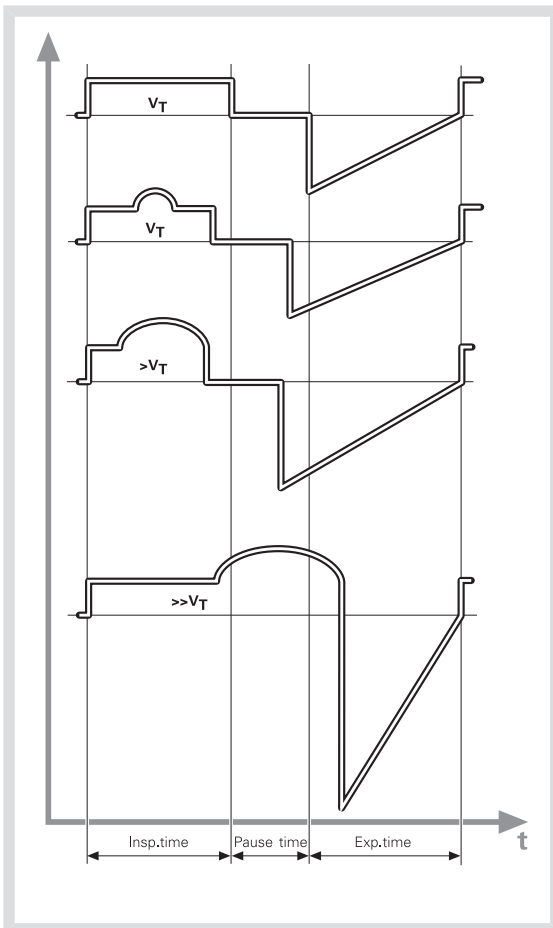

6.4.3 VOLUME CONTROL IN DETAIL

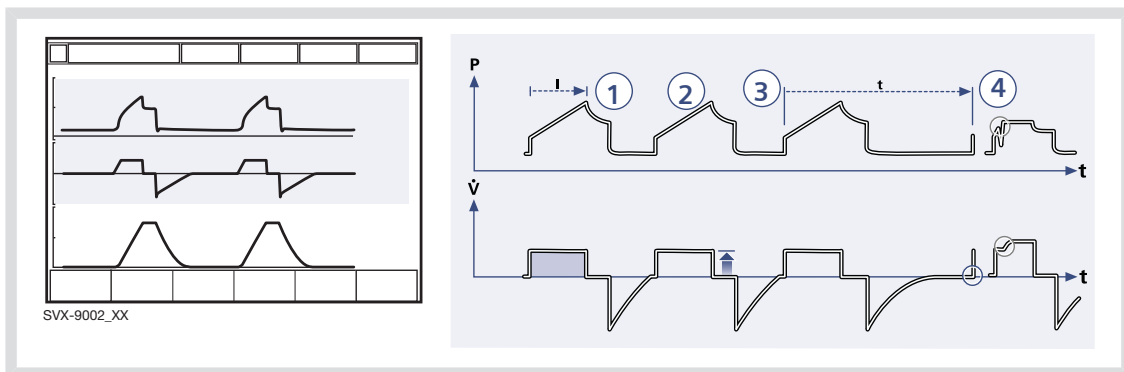

1. Volume Control assures a preset tidal volume with constant flow during a preset inspiratory time at a preset frequency.
 2. The inspiratory flow is constant and depends on User Interface setting.
 3. Inspiration starts according to the preset frequency or when the patient triggers.
 4. If the patient makes an inspiratory effort during the inspiratory period, the ventilator will switch to Pressure Support to satisfy the patient's flow demand.
- Expiration starts:**
- a. When the preset tidal volume is delivered and after the preset pause time.
 - b. When the flow returns to the set value after the preset tidal volume is delivered and after the preset pause time (on-demand support). The patient is however always guaranteed an expiration time corresponding to at least 20% of the total breath.
 - c. If the upper pressure limit is exceeded.

6.4.4 VOLUME CONTROL WITH ALTERNATIVE FLOW PATTERNS

When the *Volume Control with alternative flow patterns* is **enabled** in the start-up configuration, new touchpads for setting of alternative flow patterns are available in Volume Control, Automode VC <--> VS and SIMV (VC)+PS.

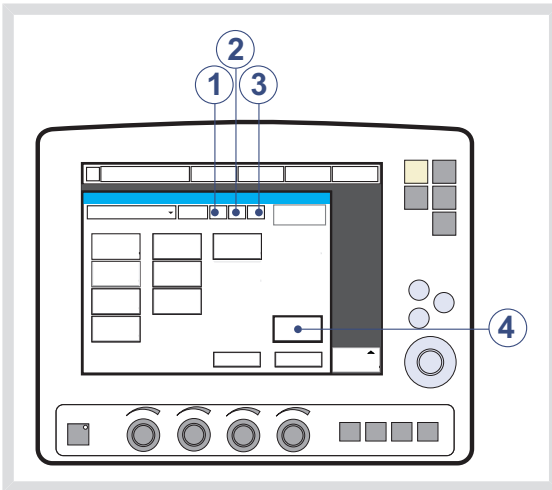

1. Volume control with flow adaptation
2. Volume control without flow adaptation
3. Volume control with decelerating flow
4. Flow pattern

See section User Interface Symbols on page 21.

Volume Control with flow adaptation

The ventilator interacts with the patient and delivers the extra volume requested regardless of the settings. See section Flow adaptation on page 86.

To ventilate with Volume Control with flow adaptation:

- Press the *Volume Control with flow adaptation* touchpad.
- Press *Accept*.

Volume Control without flow adaptation

The ventilator delivers volume strictly according to the settings.

To ventilate with Volume Control without flow adaptation:

- Press the *Volume control without flow adaptation* touchpad.
- Press *Accept*.

Note: Set trigger sensitivity at an adequate level. A patient who needs more ventilation may increase the breathing frequency instead of increasing the flow during inspiration.

Volume Control with decelerating flow

The ventilator delivers a decelerating flow according to *Flow pattern* settings.

To ventilate with decelerating flow:

- Press the *Volume control with decelerating flow* touchpad.
- Press the *Flow pattern* touchpad and set the flow pattern with the Main Rotary Dial. The flow pattern can be set so that the end inspiratory flow is 75 %, 50 % (default), 25 % or 0 % of the peak flow.
- Press *Accept*.

FLOW-TIME WAVEFORM

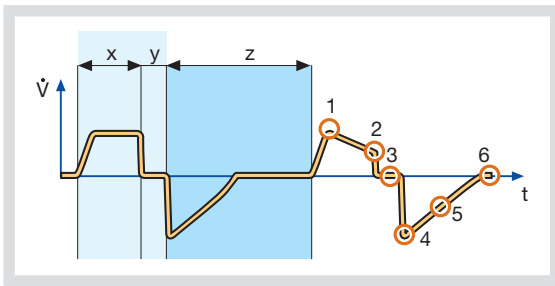

X. Inspiration time

Y. Pause time

Z. Expiration time

1. Peak inspiratory flow
2. End inspiratory flow
3. Zero flow phase
4. Peak expiratory flow
5. Slope decelerating expiratory limb
6. End expiratory flow

Notes:

- Flow adaptation is not enabled in *Volume Control with decelerating flow*. Set trigger sensitivity at an adequate level. A patient who needs more ventilation may increase the breathing frequency instead of increasing the flow during inspiration.
- The default setting of Pause time is 0 s.

STRESS INDEX

Stress index can **not** be calculated during *Volume control with decelerating flow*. It can only be calculated at a constant flow.

6.5 PRESSURE CONTROL

6.5.1 FUNCTIONAL DESCRIPTION PRESSURE CONTROL

The Pressure Controlled mode is a controlled breathing mode.

Breaths are delivered mandatorily at a preset pressure level, causing a decelerating flow pattern.

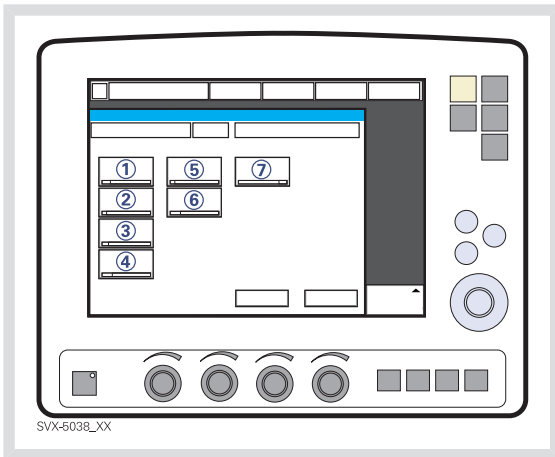

The following parameters are set:

1. PC (Pressure Control level) above PEEP (cmH₂O)
2. Respiratory Rate (b/min)
3. PEEP (cmH₂O)
4. Oxygen concentration (%)
5. I:E ratio / Insp. time
6. Inspiratory rise time (%/s)
7. Trigg. Flow / Trigg. Pressure

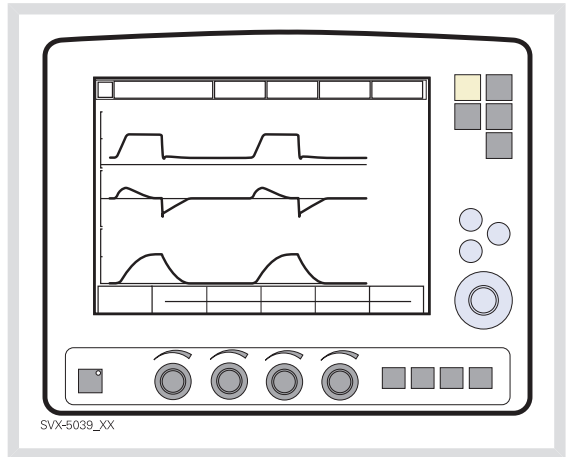

The delivered volume is dependent upon the pressure above PEEP, lung compliance and resistance in the patient tube system and airways. This means that the Tidal Volume can vary. Pressure Controlled mode is preferred when there is leakage in the breathing system e.g. due to uncuffed endotracheal tube or in situations when the maximum airway pressure must be controlled. The flow during inspiration is decelerating. The patient can trigger extra breaths. If the patient tries to exhale during the inspiration, the expiratory valve will allow exhalation as long as the pressure is more than 3 cmH₂O above the set pressure level. As the delivered tidal volume can vary it is very important to set alarm limits for Minute Volume to adequate levels.

6.5.2 PRESSURE CONTROL IN DETAIL

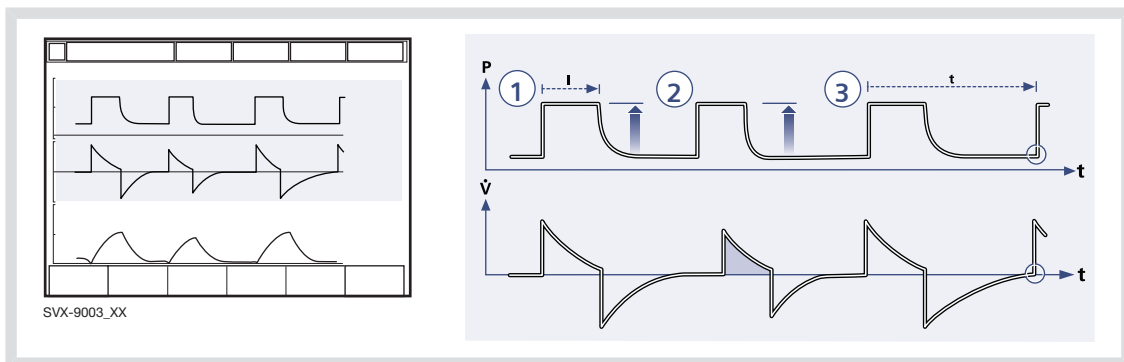

1. Pressure Control assures that the preset inspiratory pressure level is kept constant during the entire inspiration. Breaths are delivered according to the preset frequency, inspiration time and inspiratory pressure level resulting in a decelerating flow.
 - a. **Expiration starts:**
 - a. After the termination of preset inspiration time.
 - b. If the upper pressure limit is exceeded.
2. The preset pressure level is controlled by the ventilator. The resulting volume depends on the set pressure level, inspiration time and the patient's lung mechanical properties during each breath with a decelerating flow.
3. Inspiration starts according to the preset frequency or when the patient triggers.

ACTIVE EXPIRATORY VALVE

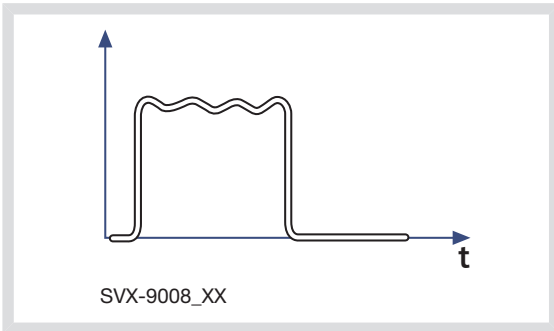

If a patient tries to exhale during the inspiration, pressure increases. When it increases 3 cmH₂O above the set inspiratory pressure level, the expiratory valve opens and regulates the pressure down to the set inspiratory pressure level.

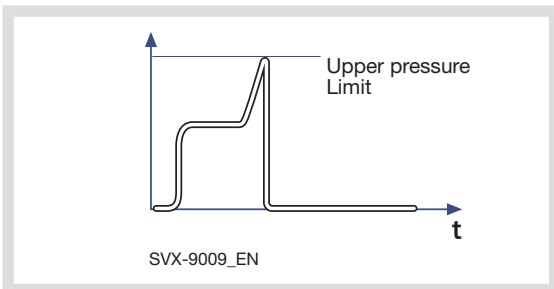

If the pressure increases to the set upper pressure limit e.g. the patient is coughing, the expiratory valve opens and the ventilator switches to expiration.

6.6 PRESSURE REGULATED VOLUME CONTROL

6.6.1 FUNCTIONAL DESCRIPTION PRVC

The Pressure Regulated Volume Control (PRVC) mode is a controlled breathing mode.

Breaths are delivered mandatorily to assure preset volumes, with a constant inspiratory pressure continuously adapting to the patient's condition. The flow pattern is decelerating.

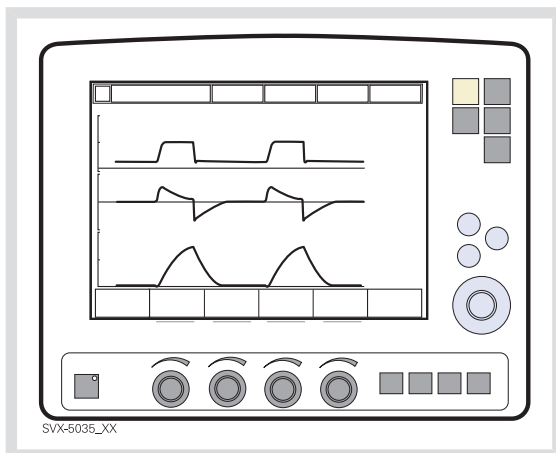

The ventilator delivers a pre-set Tidal Volume. The pressure is automatically regulated to deliver the pre-set volume but limited to 5 cmH₂O below the set upper pressure limit.

The flow during inspiration is decelerating. The patient can trigger extra breaths.

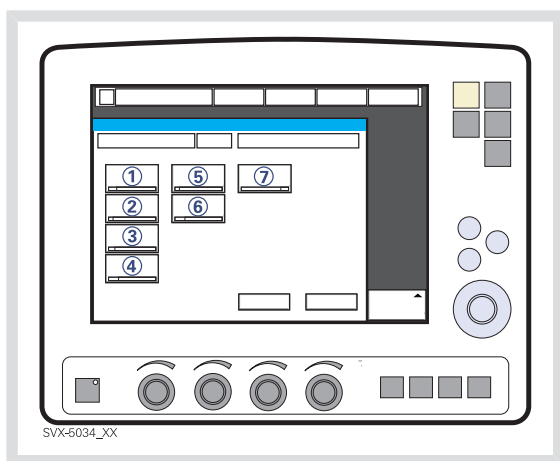

The SERVO-i Ventilator System can be configured to set Tidal Volume or Minute Volume. The following parameters are set:

1. Tidal Volume (ml) or Minute Volume (l/min)
2. Respiratory Rate (b/min)
3. PEEP (cmH₂O)
4. Oxygen concentration (%)
5. I:E ratio / Insp. time
6. Inspiratory rise time (%/s)
7. Trigg. Flow / Trigg. Pressure

6.6.2 PRVC IN DETAIL

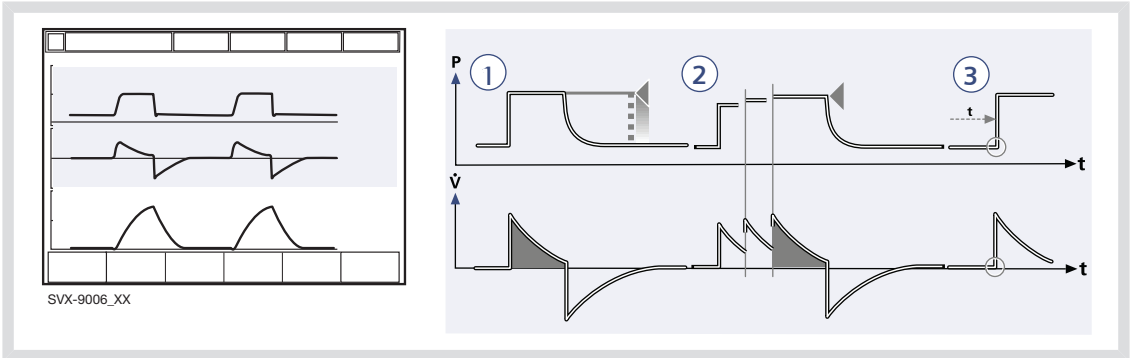

1. PRVC assures a set target minute ventilation to the patient. The target volume is based upon settings for Tidal Volume, frequency and inspiration time.
2. The inspiratory pressure level is constant during each breath, but automatically adapts in small increments breath-by-breath to match the patient's lung mechanical properties for target volume delivery.
3. Inspiration starts according to a preset frequency or when the patient triggers.

Expiration starts:

- a. After the termination of preset inspiration time
- b. If the upper pressure limit is exceeded.

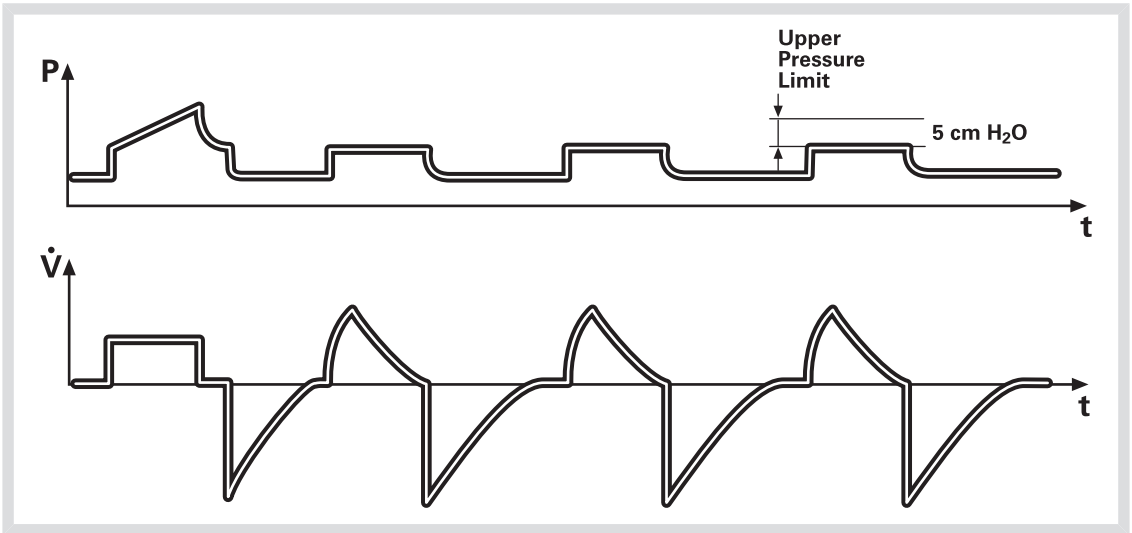

The first breath of a start sequence is a volume-controlled test breath with Pause time set to 10%. The measured pause pressure of this breath is then used as the pressure level for the following breath. An alarm is activated if the pressure level required to achieve the set target volume cannot be delivered due to a lower setting of the Upper pressure limit (- 5 cmH₂O).

6.7 VOLUME SUPPORT

6.7.1 FUNCTIONAL DESCRIPTION VOLUME SUPPORT

A patient-adapted constant inspiratory support is supplied when activated by patient effort. The resulting volume is continuously monitored and the constant inspiratory pressure automatically adjusts to the required level. The patient determines frequency and duration of the breaths which show a decelerating flow pattern.

The Volume Support mode is a patient initiated breathing mode, where the patient will be given support in proportion to their inspiratory effort and the target Tidal Volume.

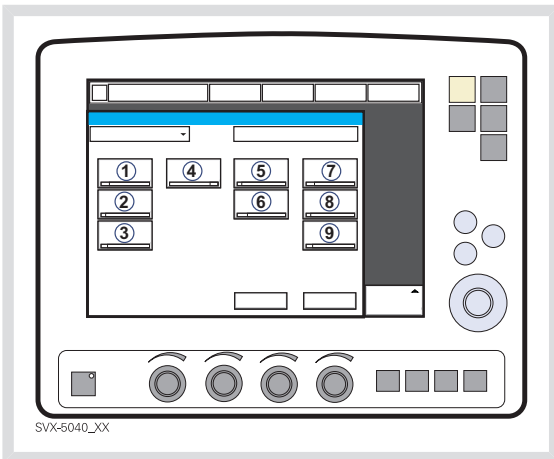

The following parameters are set:

1. Tidal Volume (ml)
2. PEEP (cmH₂O)
3. Oxygen concentration (%)
4. Inspiratory rise time (s)
5. Trigg. Flow / Trigg. Pressure
6. Inspiratory Cycle off (%)
7. Tidal Volume (ml)

8. Resp. Rate (b/min) in backup ventilation.
9. I:E / Ti (s) in backup ventilation (depending on configuration).

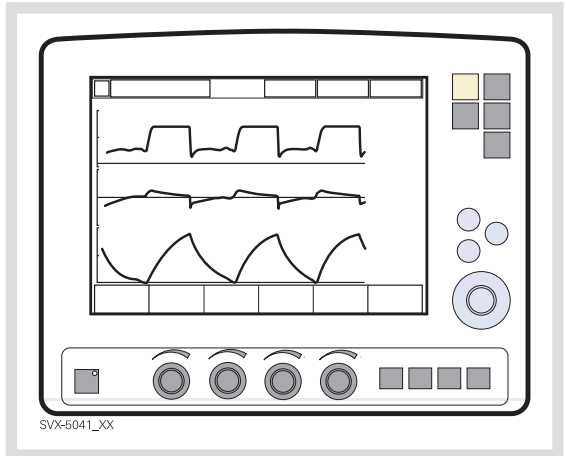

If the patient's activity increases the inspiratory pressure support will decrease provided the set Tidal Volume is maintained. If the patient breathes below the set Tidal Volume the inspiratory pressure support will increase.

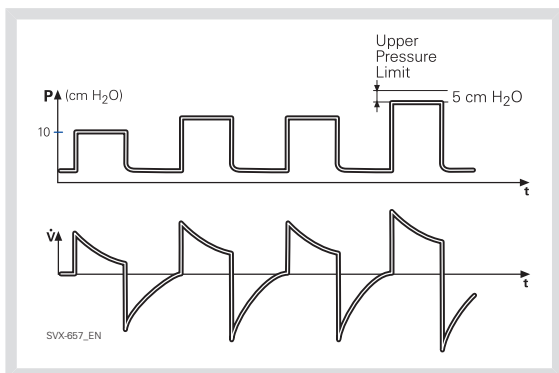

The start breath is given with 10 cmH₂O support. From that breath the ventilator calculates and continuously regulates the pressure needed to deliver the pre-set Tidal Volume.

During the next 3 breaths of the start up sequence the maximum pressure increase is 20 cmH₂O for each breath. After the start up sequence the pressure increases or decreases in steps of maximum 3 cmH₂O.

If the delivered Tidal Volume decreases below the set Tidal Volume the pressure support level is increased in steps of maximum 3 cmH₂O until preset Tidal Volume is delivered. If the pressure support level causes a larger Tidal Volume than preset, the support pressure is lowered in steps of maximum 3 cmH₂O until the preset Tidal Volume is delivered.

For maximum inspiration time, see section Functions in ventilation modes on page 233.

An alarm is activated if the pressure level required to achieve the set target volume cannot be delivered due to a lower setting of the upper pressure limit - 5 cmH₂O.

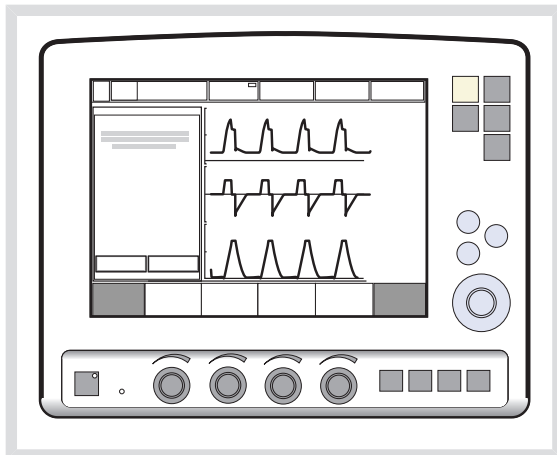

In this mode it is also important to set the apnea time appropriate to the individual patient situation. If this time is reached then the ventilator will automatically switch to backup ventilation. In all spontaneous modes it is important to set the Minute Volume alarm.

6.7.2 VOLUME SUPPORT IN DETAIL

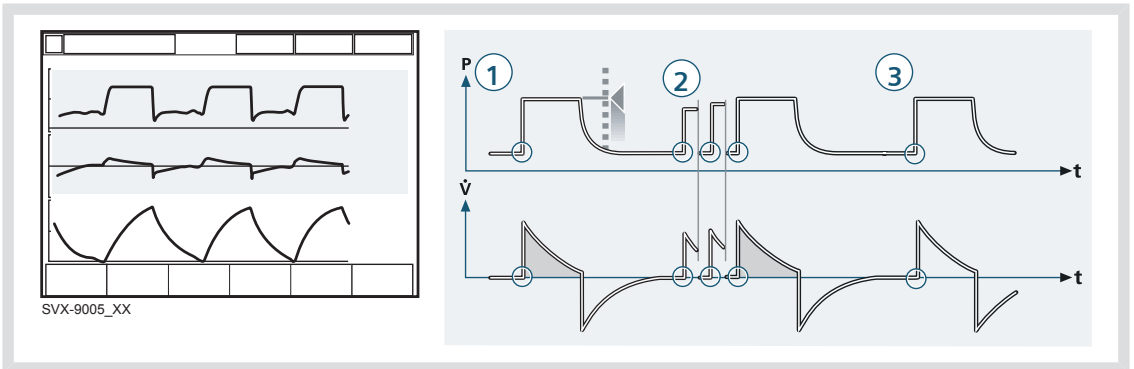

1. Volume Support assures a set target Tidal Volume upon patient effort by an adapted inspiratory pressure support.
 2. The inspiratory pressure level is constant during each breath, but alters in small increments, breath-by-breath, to match the patient's breathing ability and lung mechanical properties.
 3. Inspiration with Volume Support starts when the patient triggers.
- Expiration starts:**
- a. When the inspiratory flow decreases below a preset fraction of the inspiratory peak flow (Inspiratory cycle-off)
 - b. If the upper pressure limit is exceeded.
 - c. If the maximum time for inspiration is exceeded.

6.8 PRESSURE SUPPORT

6.8.1 FUNCTIONAL DESCRIPTION PRESSURE SUPPORT

Pressure Support is a patient initiated breathing mode in which the ventilator supports the patient with a set constant pressure.

Inspiration is supported by a constant preset pressure when activated by patient effort. The patient determines frequency and duration of the breaths, which show a decelerating flow pattern. Inspiratory breath duration can be influenced by adjusting the Inspiratory cycle-off criteria.

7. PC above PEEP (cmH₂O) in backup ventilation
8. Resp.Rate (b/min) in backup ventilation.
9. I:E / Ti (s) in backup ventilation (depending on configuration).

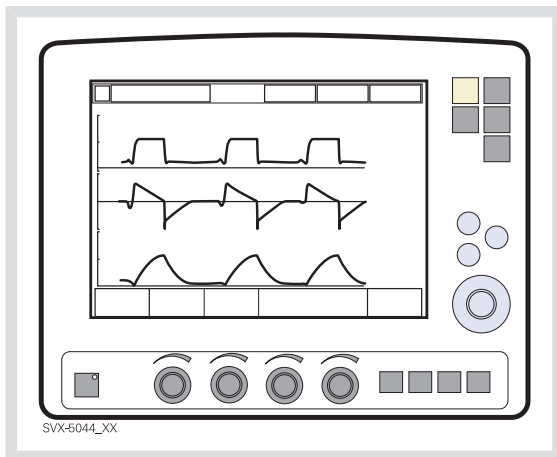

During Pressure Supported ventilation the patient regulates the respiratory rate and the Tidal Volume with support from the ventilator. The higher the pre-set inspiratory pressure level from the ventilator the more gas flows into the patient. As the patient becomes more active the pressure support level may be gradually reduced.

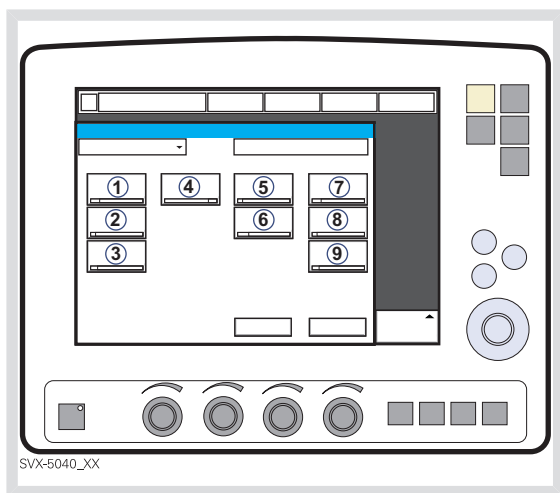

The following parameters are set:

1. PS (Pressure Support level) above PEEP (cmH₂O)
2. PEEP (cmH₂O)
3. Oxygen concentration (%)
4. Inspiratory rise time (s)
5. Trigg. Flow / Trigg. Pressure
6. Inspiratory Cycle-off (%)

Always set the Apnea time appropriate to the individual patient situation. If the apnea alarm limit is reached the ventilator will automatically switch to backup ventilation.

It is also very important to set lower and upper alarm limit for expired Minute Volume.

It is important to set the Inspiratory rise time to a comfortable value for the patient. In Pressure Support the Inspiratory rise time should normally be increased.

Inspiratory Cycle-off is important for the patient's comfort and ventilator synchronization with the patient. Inspiratory Cycle-off is the point when inspiration switches to expiration. E.g. for a patient with expiratory resistance the inspiratory Cycle-off should be set to a high value to guarantee enough time for expiration.

Note: It is important to monitor the corresponding Tidal Volume levels.

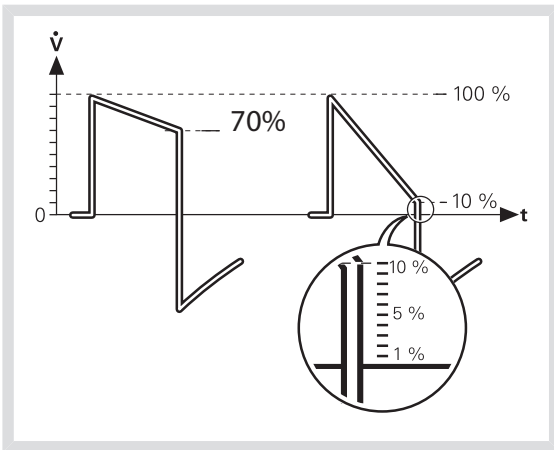

For maximum inspiration time, see section Functions in ventilation modes on page 233.

6.8.2 PRESSURE SUPPORT IN DETAIL

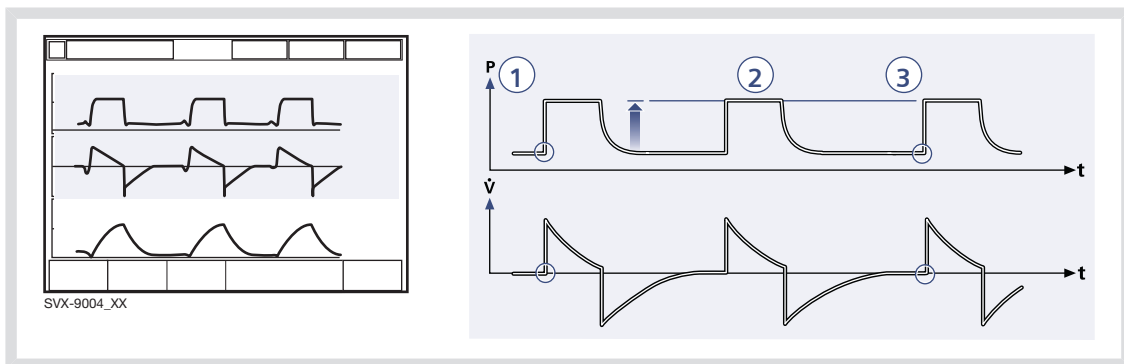

1. Pressure Support assures that a preset inspiratory pressure level is constantly maintained upon patient effort.
 2. The preset pressure level is controlled by the ventilator, while the patient determines frequency and inspiration time.
 3. Inspiration starts when the patient triggers a breath, gas flows into the lungs at a constant pressure. Since the pressure provided by the ventilator is constant, the flow will decrease until the Inspiratory Cycle-off is reached.
- Expiration starts:**
- a. When the inspiratory flow decreases below a preset fraction of the inspiratory peak flow (Inspiratory cycle-off)
 - b. If the upper pressure limit is exceeded.
 - c. If the maximum time for inspiration is exceeded.
 - d. If the flow drops to a flow range between 25% of the peak flow and lower limit for Inspiratory Cycle-off fraction level and the spent time within this range exceeds 50% of the time spent in between the start of the inspiration and entering this range.

6.9 SPONTANEOUS/CPAP

6.9.1 FUNCTIONAL DESCRIPTION SPONTANEOUS BREATHING/CPAP

True spontaneous breathing (CPAP) occurs when the inspiratory pressure level is set to zero in Pressure Support.

The mode Continuous Positive Airway Pressure is used when the patient is breathing spontaneously.

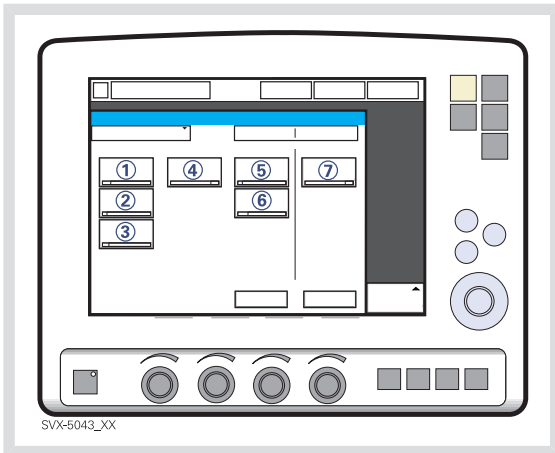

The following parameters are set:

1. PS (Pressure Support level) above PEEP (cmH₂O)
2. PEEP (cmH₂O)
3. Oxygen concentration (%)
4. Inspiratory rise time (s)
5. Trigg. Flow / Trigg. Pressure
6. Inspiratory Cycle-off (%)
7. PC (pressure control level) above PEEP (cmH₂O).

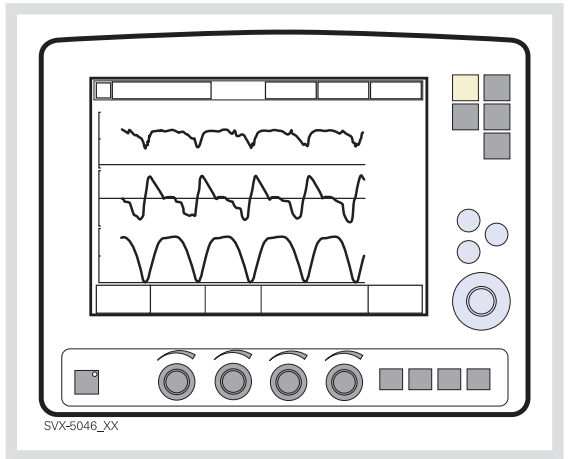

A continuous positive pressure is maintained in the airways. Properly set this may prevent collapse of airways. Inspiration starts upon patient effort. Expiration starts as for Pressure Support above.

Always set the Apnea time appropriately to the individual patient situation. If the apnea alarm limit is reached the ventilator will automatically switch to backup ventilation.

The alarm should alert staff to take action, either to go back to supported mode or change to a controlled mode of ventilation.

It is also very important to set lower and upper alarm limit for expired Minute Volume

For maximum inspiration time, see section Functions in ventilation modes on page 233.

6.9.2 SPONTANEOUS BREATHING/CPAP IN DETAIL

- True spontaneous breathing will occur:
 - In Volume Support when the target volume is maintained without support (automatically regulated by the ventilator)
 - In Pressure Support when the inspiratory pressure level is set to zero
 - In Automode when either of the above defined conditions is met.
- Inspiration starts upon patient effort.

Expiration starts:

- a. When the inspiratory flow decreases below a preset fraction of the inspiratory peak flow (Inspiratory cycle-off)
- b. If the upper pressure limit is exceeded.
- c. Maximum time for inspiration is exceeded.

6.10 AUTOMODE

6.10.1 AUTOMODE FUNCTIONAL DESCRIPTION

Automode enables the ventilator to adapt to the patient's changing breathing capacity. It offers a combination of controlled and supported modes between which it shifts automatically, allowing better patient-ventilator interaction.

When the patient is making a breathing effort, the ventilator immediately switches to a supported mode of ventilation. If the patient is not making any breathing effort, the ventilator will return to the controlled mode and deliver controlled breaths.

The possible combinations are:

Volume Control <----> Volume Support

PRVC <----> Volume Support

Pressure Control <----> Pressure Support.

Note: Automode is not possible in NIV.

6.10.2 VOLUME CONTROL<-->VOLUME SUPPORT

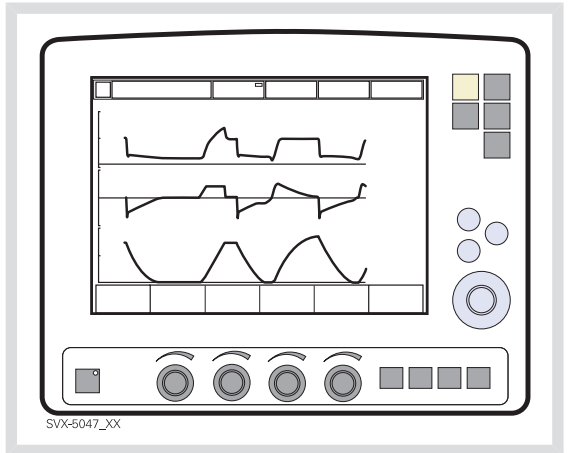

The ventilator uses the plateau pressure in the Volume Controlled breath as a reference pressure for the first Volume Supported breath.

AUTOMODE (VC) <--> VS WITH ALTERNATIVE FLOW PATTERNS

When the *Volume Control with alternative flow patterns* is **enabled** in the start-up configuration, new touchpads for setting of alternative flow patterns are available in Volume Control, Automode VC <--> VS and SIMV (VC)+PS.

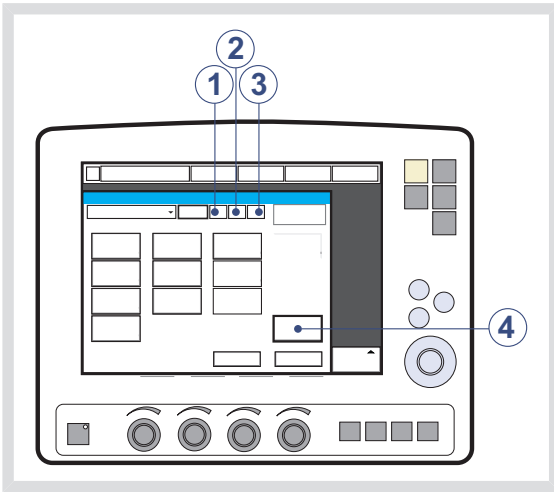

1. Volume control with flow adaptation
2. Volume control without flow adaptation
3. Volume control with decelerating flow
4. Flow pattern

See section Volume control with alternative flow patterns on page 89 for more information.

6.10.3 PRVC <-> VOLUME SUPPORT

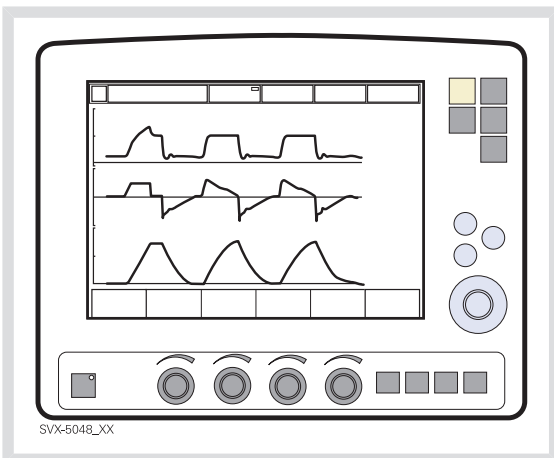

The first supported breath delivered to the patient has the same pressure level as the preceding PRVC breath.

6.10.4 PRESSURE CONTROL<->PRESSURE SUPPORT

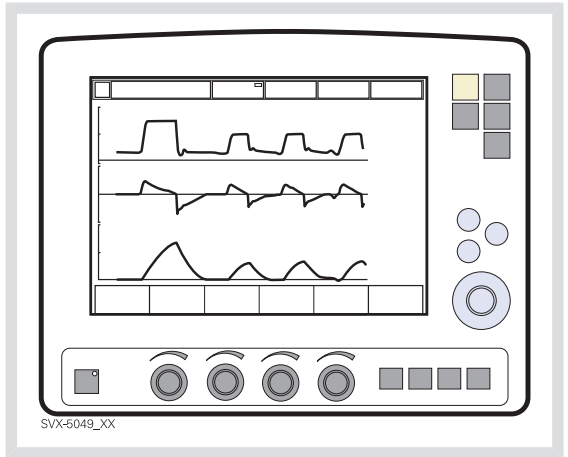

In this combination of Automode – Pressure Control and Pressure Support – the Direct Access Knob will always regulate the Pressure Control level (PC above PEEP). The Pressure Support level (PS above PEEP) can be adjusted through Additional Settings or in the Ventilation Mode window.

6.10.5 AUTOMODE IN DETAIL

1. The ventilator starts in control mode and operates according to the Volume Control, PRVC or Pressure Control mode. If the patient triggers a breath, the ventilator will turn to support mode, to encourage the patient's respiratory drive.
2. If the patient is breathing adequately:
 - a. In Volume Support the ventilator adjusts the inspiratory pressure level breath-by-breath to assure the preset target volume.
 - b. In Pressure Support the ventilator assures that the preset inspiratory pressure level is maintained constantly during the entire inspiration.

3. Exceeding the default or manually set trigger timeout limit without a sufficient patient effort will cause:
 - a. In Volume Support; a PRVC or Volume controlled breath will be delivered according to the selected automode functionality.
 - b. In Pressure Support; a Pressure controlled breath will be delivered.
4. The ventilator initially adapts with a dynamic trigger timeout limit. This means that for the spontaneously triggering patient, the trigger timeout limit increases successively until the set trigger timeout limit is reached.

PRVC - VOLUME SUPPORT

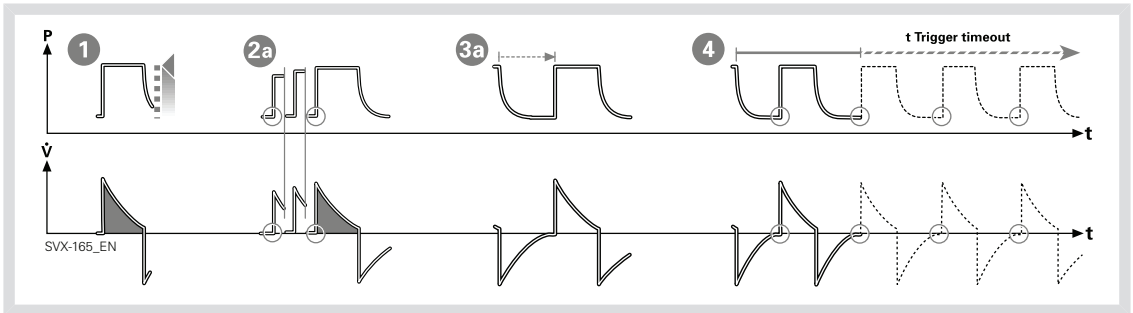

VOLUME CONTROL - VOLUME SUPPORT

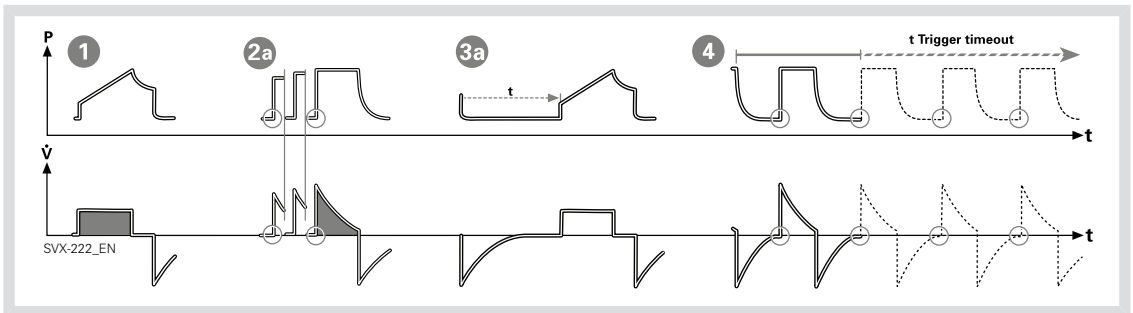

PRESSURE CONTROL - PRESSURE SUPPORT

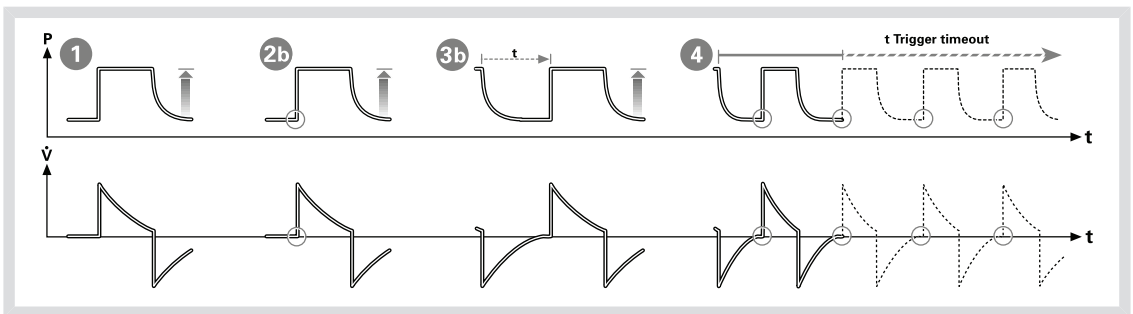

6.11 SIMV

6.11.1 FUNCTIONAL DESCRIPTION SIMV

SIMV is a combination mode where the patient receives mandatory breaths synchronized with his breathing efforts and according to the selected SIMV mode. The patient can breathe spontaneously with Pressure Support in between the mandatory breaths.

There are three different SIMV modes, depending on the modes installed:

- SIMV (Volume Control) + Pressure Support
- SIMV (Pressure Control) + Pressure Support
- SIMV (PRVC) + Pressure Support

The mandatory breath is defined by the basic settings (as shown in the table below): Minute Volume/Tidal Volume (depending on configuration), PC above PEEP, I:E ratio/Inspiration time (depending on configuration), Pause time, Inspiratory rise time and Breath cycle time.

Note: In the Minute Volume configuration the Tidal Volume is determined by Minute Volume divided by SIMV rate.

The Breath cycle time is the length of the mandatory breath in seconds.

For example: A SIMV rate of 6, a breath cycle time of 3 seconds with an I:E ratio of 1:2 means that the inspiration will take 1 second and the expiration 2 seconds.

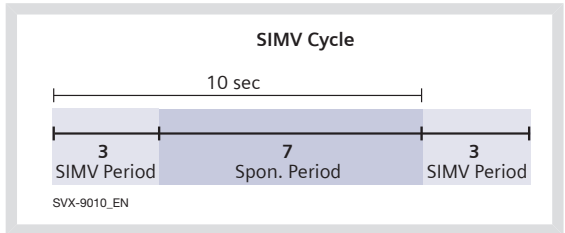

During the SIMV period, the first triggered breath will be a mandatory breath. If the patient has not triggered a breath within the first 90% of the Breath Cycle time a mandatory breath will be delivered.

Note: If the ventilator is configured for setting of Inspiration time, an I:E ratio of 1:2 will be used to estimate the Breath cycle time.

The spontaneous/pressure supported breaths are defined by setting the Pressure support level above PEEP.

6.11.2 THE MANDATORY BREATH

	SIMV (VC)+ PS	SIMV (PC) + PS	SIMV (PRVC)+PS
PC above PEEP		X	
Tidal volume /Minute volume	X		X
SIMV rate	X	X	X
Breath cycle time	X ¹	X ¹	X ¹
I:E ratio / Inspiration time	X	X	X
Insp. rise time	X	X	X
Pause time	X		

¹ Only when the ventilator is configured for I:E ratio setting.

6.11.3 SIMV (VOLUME CONTROL) + PRESSURE SUPPORT

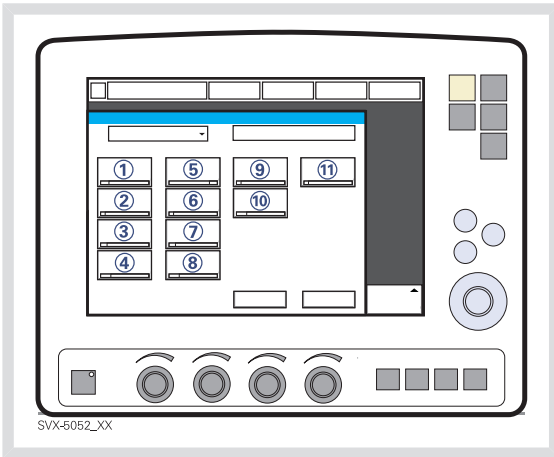

The following parameters are set:

1. Tidal Volume (ml)/Minute Volume (l/min)
2. SIMV rate (b/min)
3. PEEP (cmH₂O)
4. Oxygen concentration (%)
5. I:E ratio / Insp. time
6. Pause time (%/s)
7. Inspiratory rise time (%/s)
8. Breath cycle time (s)

Note: The touchpad Breath cycle time is not shown when an SIMV mode is selected and the ventilator is configured for inspiration time.

9. Trigg. Flow / Trigg. Pressure
10. Inspiratory Cycle-off (%)

11. PS (Pressure Support level) above PEEP (cmH₂O)

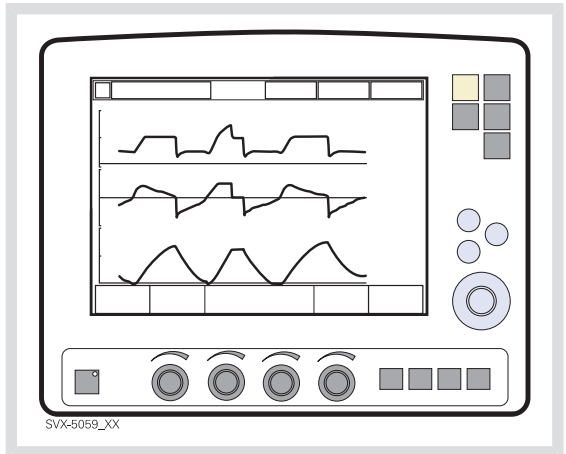

6.11.4 SIMV - IN DETAIL

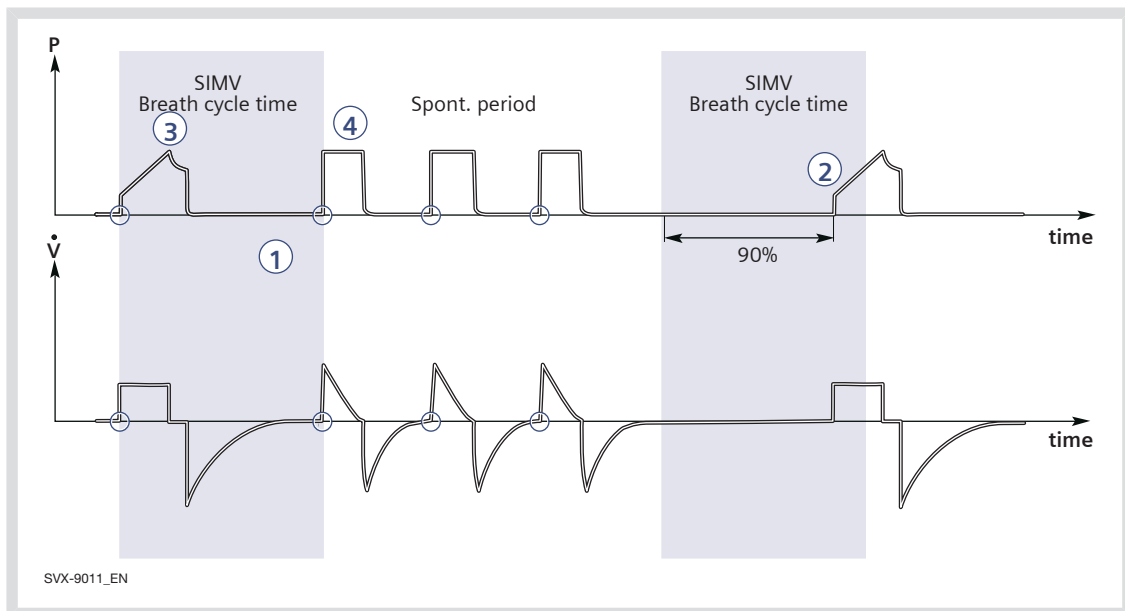

1. This combined control and pressure support/spontaneous function allows for preset mandatory breaths synchronized with the patient's breathing.
2. If there is no trigger attempt within a time window equal to 90% of the set Breath cycle time, a mandatory breath is delivered. (The Breath cycle time is the total time for one mandatory breath.)
3. The mandatory breath is defined by the basic settings (mode of ventilation, breath cycle time, respiratory pattern and volumes/pressures).
4. The spontaneous/pressure supported breaths are defined by the setting for Pressure Support.

SIMV (VC) + PS WITH ALTERNATIVE FLOW PATTERNS

When the *Volume Control with alternative flow patterns* is **enabled** in the start-up configuration, new touchpads for setting of alternative flow patterns are available in Volume Control, Automode VC <--> VS and SIMV (VC)+PS.

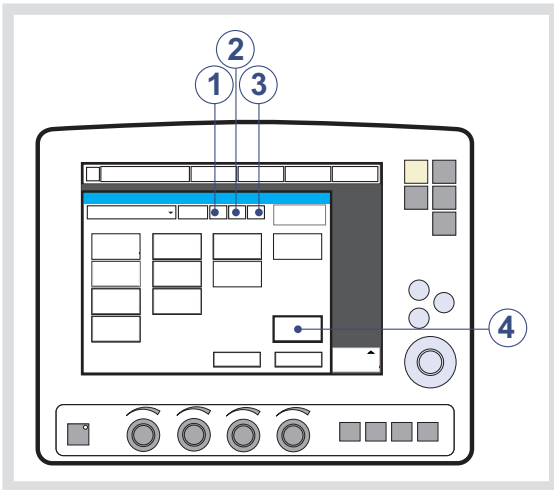

1. Volume control with flow adaptation
2. Volume control without flow adaptation
3. Volume control with decelerating flow
4. Flow pattern

See section *Volume control with alternative flow patterns* on page 89 for more information.

6.11.5 SIMV (PRESSURE CONTROL) + PRESSURE SUPPORT

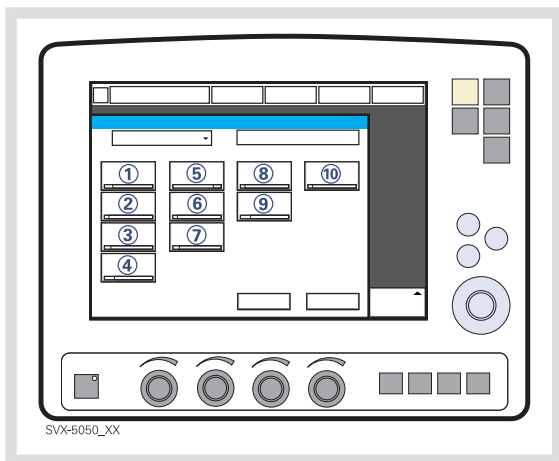

10. PS (Pressure Support level) above PEEP (cmH₂O)

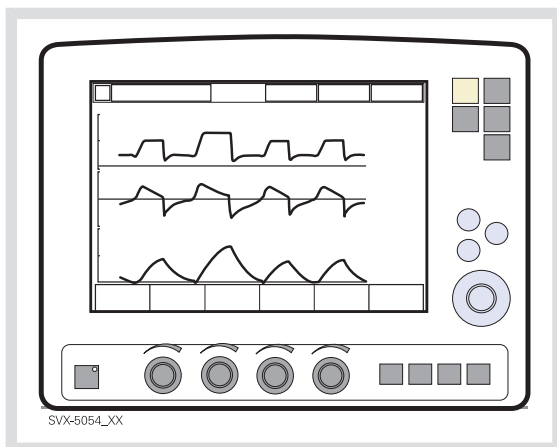

The following parameters are set:

1. PC (Pressure Control level) above PEEP (cmH₂O)
2. SIMV rate (b/min)
3. PEEP (cmH₂O)
4. Oxygen concentration (%)
5. I:E ratio / Insp. time
6. Inspiratory rise time (%/s)
7. Breath cycle time (s)

Note: The touchpad Breath cycle time is not shown when an SIMV mode is selected and the ventilator is configured for inspiration time.

8. Trigg. Flow / Trigg. Pressure
9. Inspiratory Cycle-off (%)

6.11.6 SIMV - IN DETAIL

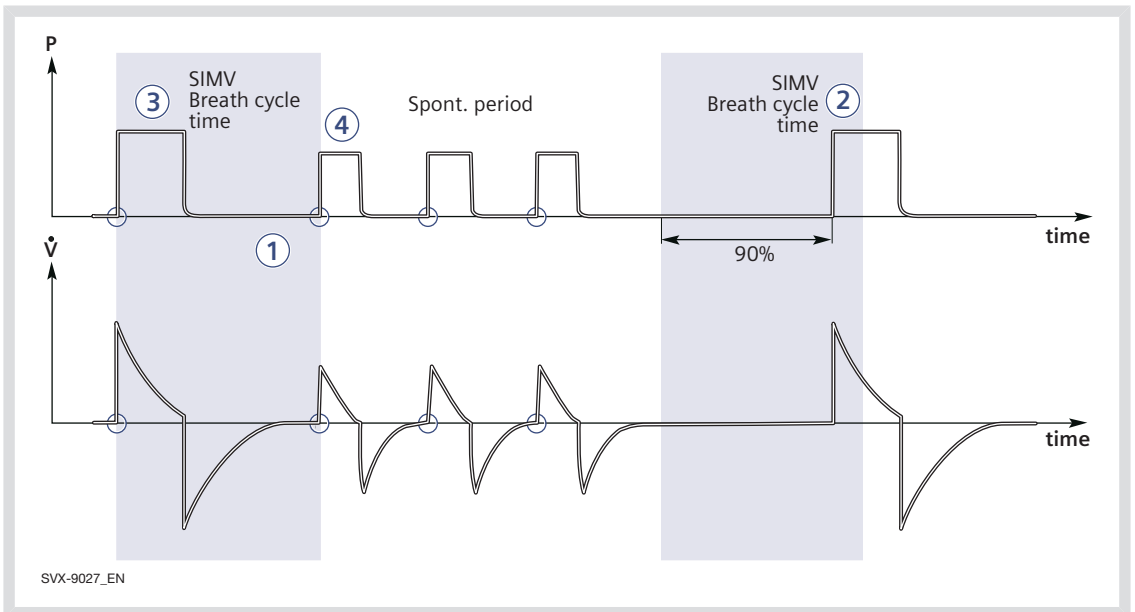

1. This combined control and pressure support/spontaneous function allows for preset mandatory breaths synchronized with the patient's breathing.
2. If there is no trigger attempt within a time window equal to 90% of the set Breath cycle time, a mandatory breath is delivered. (The Breath cycle time is the total time for one mandatory breath.)
3. The mandatory breath is defined by the basic settings (mode of ventilation, breath cycle time, respiratory pattern and volumes/pressures).
4. The spontaneous/pressure supported breaths are defined by the setting for Pressure Support.

6.11.7 SIMV (PRVC) + PRESSURE SUPPORT

10. PS (Pressure Support level) above PEEP (cmH₂O)

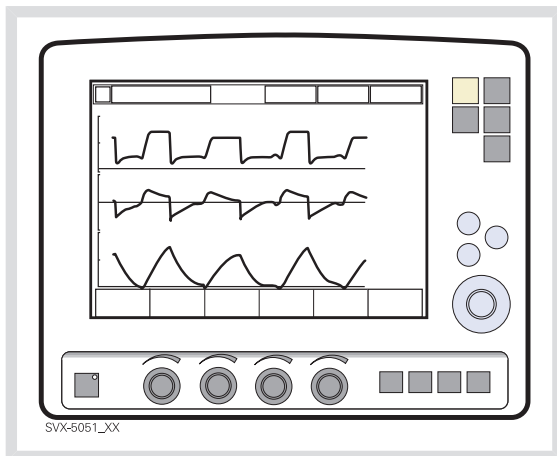
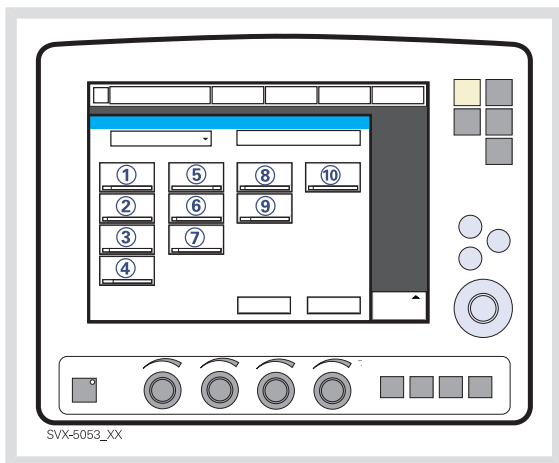

The following parameters are set:

1. Tidal Volume (ml)/Minute Volume (l/min)
2. SIMV rate (b/min)
3. PEEP (cmH₂O)
4. Oxygen concentration (%)
5. I:E ratio / Insp. time
6. Inspiratory rise time (%/s)
7. Breath cycle time (s)

Note: The touchpad Breath cycle time is not shown when an SIMV mode is selected and the ventilator is configured for inspiration time.

8. Trigg. Flow / Trigg. Pressure
9. Inspiratory Cycle-off (%)

6.11.8 SIMV - IN DETAIL

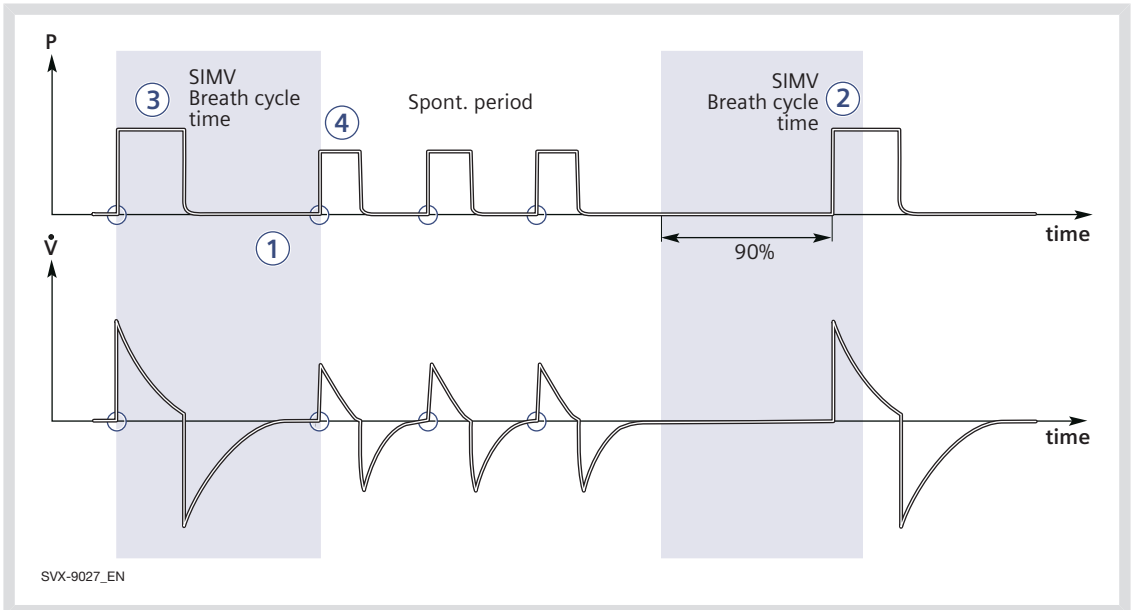

1. This combined control and pressure support/spontaneous function allows for preset mandatory breaths synchronized with the patient's breathing.
2. If there is no trigger attempt within a time window equal to 90% of the set Breath cycle time, a mandatory breath is delivered. (The Breath cycle time is the total time for one mandatory breath.)
3. The mandatory breath is defined by the basic settings (mode of ventilation, breath cycle time, respiratory pattern and volumes/pressures).
4. The spontaneous/pressure supported breaths are defined by the setting for Pressure Support.

6.12 BI-VENT/APRV

Bi-Vent:

- is a time-cycled, pressure-limited mode that allows spontaneous breathing throughout the entire ventilatory cycle;
- has two time-cycled pressure levels and switches between these two levels. The patient can breathe spontaneously at both these levels and it is possible to give Pressure Support at both levels.

APRV:

- stands for Airway Pressure Release Ventilation;
- is a time-cycled, pressure-limited mode that allows spontaneous breathing throughout the entire ventilatory cycle;
- alternates between two levels of positive airway pressure, with the main time on the high level and a brief expiratory release to facilitate ventilation;
- differs from Bi-Vent in that it uses an inverse I:E ratio.

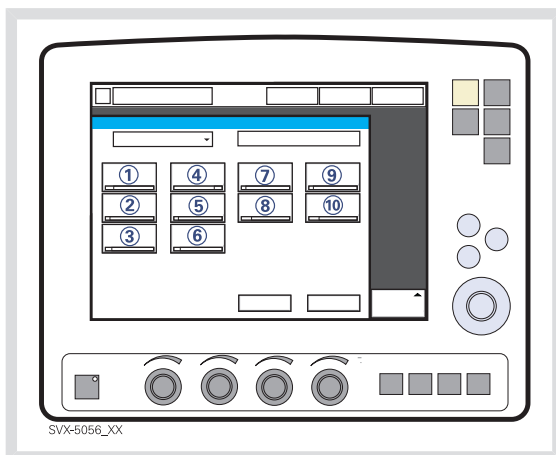

The following parameters are set:

1. Pressure high (PHigh) for the higher pressure level (cmH₂O)
2. PEEP for the lower pressure level (cmH₂O)
3. Oxygen concentration (%)
4. Time at the higher pressure (THigh) level (s)
5. Time at the lower pressure (TPEEP) level (s)
6. Inspiratory rise time (s)
7. Trigg. Flow / Trigg. Pressure
8. Inspiratory Cycle-off (%)
9. PS (Pressure Support level) above PHigh (cmH₂O)
10. PS (Pressure Support level) above PEEP (cmH₂O)

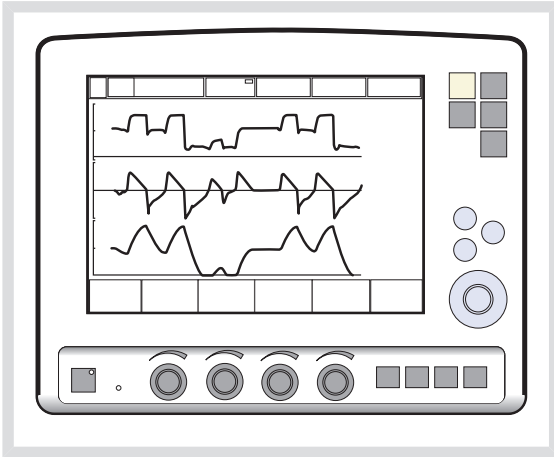

Bi-Vent/APRV allows for spontaneous breathing/PS ventilation at two different pressure levels. These basic levels are individually set, as well as the time in seconds at each level. The ventilator system always tries to synchronize with the patient's breathing. The main difference between Bi-Vent and APRV is the inverse I:E ratio in APRV.

Since Bi-Vent/APRV is basically a controlled mode of ventilation, apnea alarm and backup ventilation are not available. It is also very important to set the lower and upper alarm limit for expired minute volume.

Each Bi-Vent/APRV cycle is regarded as autonomous and therefore most of the measured values are updated every cycle, i.e. minute volume, respiratory rate, mean pressure and end expiratory pressure. Associated alarms are also handled for every cycle.

At extreme settings, the update of measured values and alarms will show a mandatory frequency dependence even in the face of preserved spontaneous breathing.

As a result of switching between two different pressure levels, the tidal volumes may vary significantly between different breaths. This may also be the case for etCO_2 concentration.

6.12.1 BI-VENT IN DETAIL

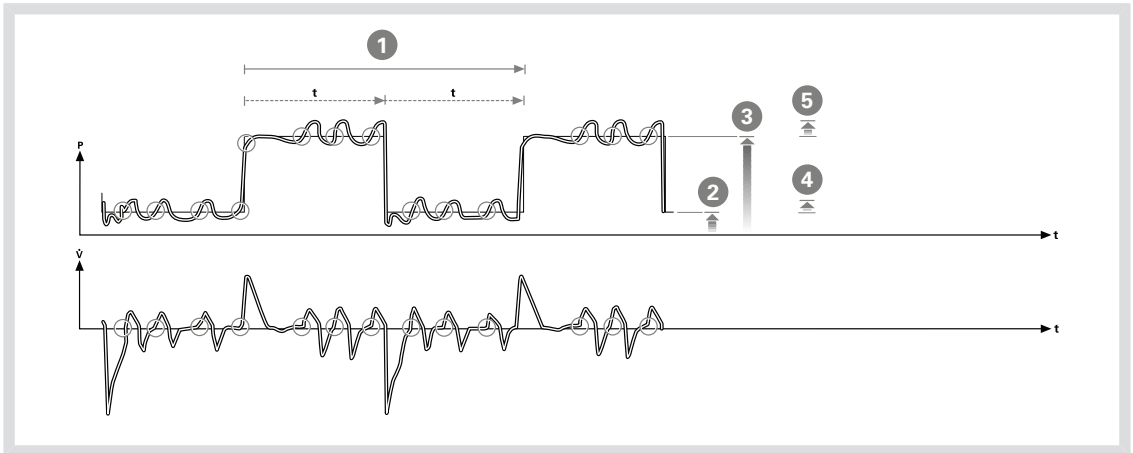

This function allows for spontaneous breathing / pressure supported ventilation at two different pressure levels. These basic levels are individually set, as well as the time in seconds at each level. The ventilator always tries to synchronize with the patient's breathing.

1. Bi-Vent cycle; THigh + TPEEP
2. PEEP
3. PHigh
4. PS above PEEP
5. PS above PHigh

6.13 NON INVASIVE VENTILATION

6.13.1 NON INVASIVE VENTILATION

This chapter refers to when the SERVO-i Ventilator System is used during Non Invasive Ventilation (NIV). NIV refers to ventilation, where the patient is not intubated or tracheotomized. It is achieved using a nasal mask, face mask, full-face mask or prongs. See chapter Optional Accessories, section NIV Helmet on page 199 for further information about using a helmet.

Note: In NIV, flow and pressure curves and the measured values: VT_i, VT_e, MV_e, MV_i are compensated for leakage.

The *NIV disconnect function* is available in all NIV modes including Nasal CPAP and can be set via the *Biomed>Edit startup configuration* window.

The setting can be used to ensure a constant disconnect flow while ventilation is paused (High flow and Low flow) or as a way to avoid pausing ventilation in case of high leakage (Disabled).

For NIV disconnect function settings, see *Functions in ventilation modes* on page 233.

WARNINGS!

- Avoid high inspiratory pressure as it may lead to gastric overdistension and risk of aspiration. It may also cause excessive leakage.
- The dead space will increase when using a mask or prongs.
- NIV is not intended to be used on intubated patients.
- CO₂ measurement will be affected by mask / prongs leakage.
- In non-invasive ventilation, the measured expired volume may be different from the actual volume exhaled by the patient due to leakage around the mask.

CAUTIONS:

- Mask / prongs leakage might affect the nebulizer efficiency.
- It is not recommended to use the nebulizer during NIV as the nebulized drug might come in contact with the patient eyes in case of leakage.

Important:

- The mask / prongs must be properly applied in order to minimize leakage.
- Selection of the mask / prongs must take into consideration proper size and an accurate adaptation to the patient.
- CO₂ rebreathing will increase during NIV and use of a face mask / prongs.

Read about alarm settings on page 180.

See also *Set Ventilation Mode* on page 53.

6.13.2 FUNCTIONAL DESCRIPTION PRESSURE CONTROL

The NIV Pressure Controlled mode is a controlled breathing mode.

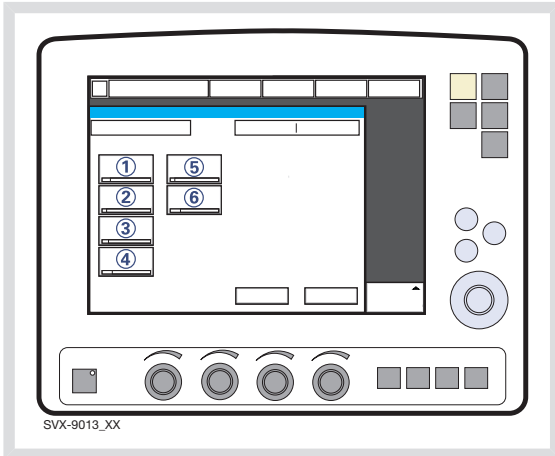

The following parameters are set:

1. PC (Pressure Control level) above PEEP (cmH₂O)
2. Respiratory Rate (b/min)
3. PEEP (cmH₂O)
4. Oxygen concentration (%)
5. I:E ratio / Insp. time
6. Inspiratory rise time (%/s)

Differences from invasive Pressure control mode:

- When the Standby key is pressed a waiting position dialog is shown. All patient related alarms are turned off during 120 seconds. Press the Start ventilation touchpad to start the ventilation.
- During NIV the ventilator automatically adapts to variations in leakage in order to maintain the required pressure and PEEP level. If leakage is excessive, the ventilator will issue a high priority alarm and deliver a flow according to settings. Ventilation will resume automatically if the leakage decreases. Ventilation can also be started manually by pressing the *Resume ventilation* touchpad in the dialog.
- Trigger sensitivity cannot be set in NIV.
- Detection of pressure below PEEP or expiratory volume decrease will start a new breath.

Read about alarm settings on page 180.

See also *Set Ventilation Mode* on page 53.

6.13.3 FUNCTIONAL DESCRIPTION PRESSURE SUPPORT

NIV PS is a patient initiated breathing mode in which the ventilator supports the patient with a set constant pressure.

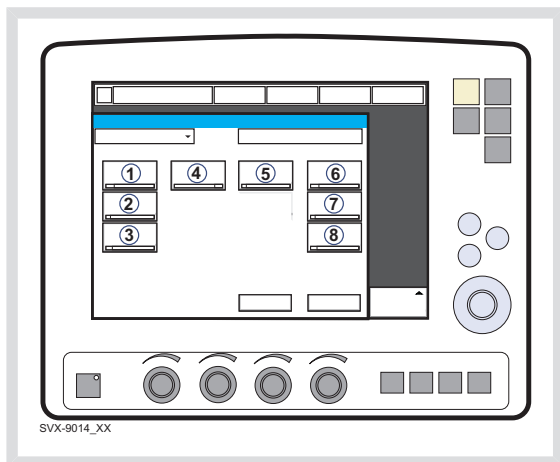

The following parameters are set:

1. PS (Pressure Support level) above PEEP (cmH₂O)
2. PEEP (cmH₂O)
3. Oxygen concentration (%)
4. Inspiratory rise time (s)
5. Inspiratory Cycle-off (%)
6. PC above PEEP (cmH₂O) in backup ventilation
7. Resp.Rate (b/min) in backup ventilation.
8. I:E / Ti (s) in backup ventilation (depending on configuration).

Differences from invasive Pressure support mode:

- When the Standby key is pressed a waiting position dialog is shown. All patient related alarms are turned off during 120 seconds. Press the Start ventilation touchpad to start the ventilation.
 - During NIV the ventilator automatically adapts to variations in leakage in order to maintain the required pressure and PEEP level. If leakage is excessive, the ventilator will issue a high priority alarm and deliver a flow according to settings. Ventilation will resume automatically if the leakage decreases. Ventilation can also be started manually by pressing the *Resume ventilation* touchpad in the dialog.
 - The ventilator will not lock in backup ventilation. There is no limit on the number of times the ventilator can switch between supported mode and backup.
 - Trigger sensitivity cannot be set in NIV.
- Read about alarm settings on page 180.

See also *Set Ventilation Mode* on page 53.

6.14 NASAL CPAP (INFANT ONLY)

6.14.1 FUNCTIONAL DESCRIPTION NASAL CPAP

The mode Nasal Continuous Positive Airway Pressure is used when the patient is breathing spontaneously.

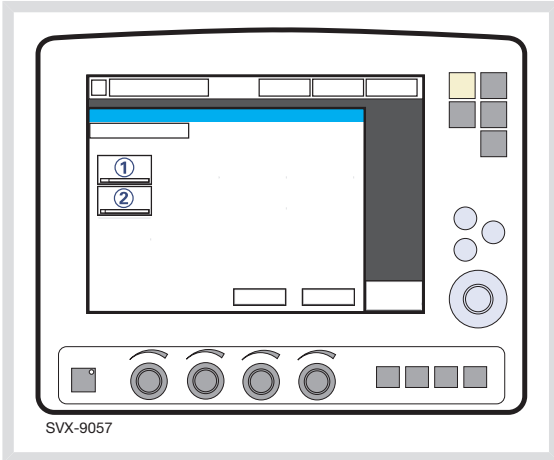

The following parameters are set:

1. CPAP (cmH₂O)
2. Oxygen concentration (%)

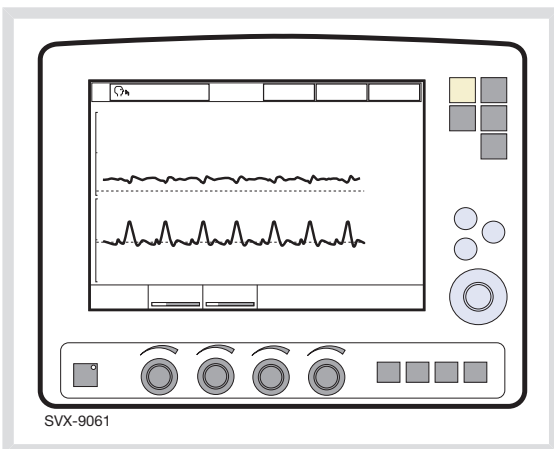

During NIV the ventilator automatically adapts to the variation of leakage in order to maintain the required pressure. If the leakage is excessive, the ventilator will issue a high priority alarm, deliver a continuous flow and pause breath cycling. Ventilation will resume automatically if the leakage decreases. Ventilation can also be started manually by pressing the Start ventilation touchpad in the excessive leakage dialog.

Differences from invasive CPAP

- When the Standby key is pressed a waiting position dialog is shown. All patient related alarms are turned off during 120 seconds. Press the Start ventilation touchpad to start the ventilation.
- Trigger and cycle-off is automatically adapted to the leakage and cannot be set in Nasal CPAP.
- There is no backup ventilation available in Nasal CPAP.
- The apnea alarm can be turned off in Nasal CPAP.
- The following functions are not available during Nasal CPAP ventilation:
 - Volume curve
 - Loops
 - Open Lung Tool
 - Additional values
 - Additional settings
 - Inspiratory hold
 - Expiratory hold
 - CO₂ Analyzer.

WARNINGS!

- When using Nasal CPAP, make sure that the airways are kept clear of mucus and debris.
- If Nasal prongs are used make sure that they are applied so that air can flow freely through both prongs.
- Patient effort and artifacts affecting patient flow or pressure such as heart beats, movement of patient tubing, intermittent leakage may not always be correctly detected or discriminated. This may affect the accuracy of alarms and measured parameters, so therefore we advise that additional patient monitoring should be in place.

Important:

- The patient interface (e.g. nasal mask, nasal prongs, endotracheal tube above the vocal cords) must be properly applied in order to avoid leakage.
- Make sure that the patient interface is the correct size and is accurately adapted to the patient.
- CO₂ re-breathing will increase during Nasal CPAP if a nasal or facial mask is used.

Read about alarm settings on page 180.

See also *Set Ventilation Mode* on page 53.

6.15 BACKUP VENTILATION

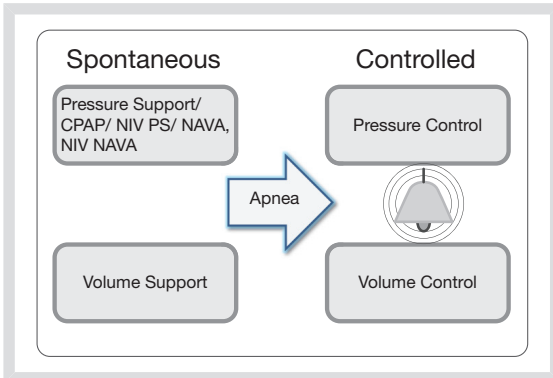

Backup ventilation is available in all support modes (not applicable in Automode and Nasal CPAP).

For apnea alarm setting range, see section Alarm limits on page 231.

The minimum backup pressure level is 5 cmH₂O.

See the tabulated breathing parameter settings on page 228.

6.15.1 FUNCTIONAL DESCRIPTION

Backup ventilation switches in invasive ventilation from Volume Support to Volume Control and from Pressure Support/CPAP and NAVA to Pressure Control and in non invasive ventilation from both NIV Pressure Support and NIV NAVA to NIV Pressure Control.

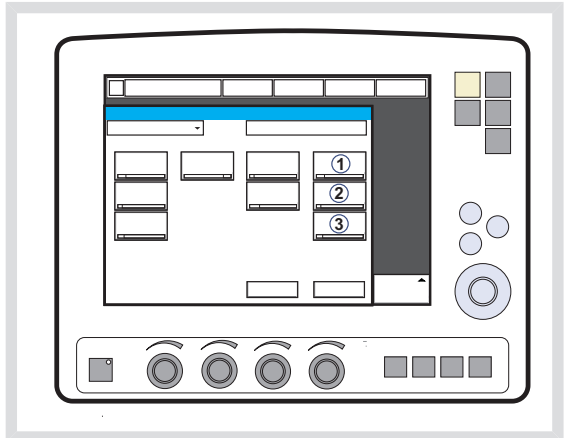

The following parameters are set:

1. PC above PEEP (cmH₂O) in backup ventilation, Pressure Support and NAVA. Tidal Volume (ml) in backup ventilation, Volume Support.
2. Resp.Rate (b/min) in backup ventilation.
3. I:E / Ti (s) in backup ventilation (depending on configuration).

NO PATIENT EFFORT

In case of apnea, the ventilator will switch to backup ventilation according to the backup settings at the end of the set apnea time.

The *Apnea time* is set in the *Alarm Profile* window.

Backup is indicated in the active *Ventilation mode* touchpad and the alarm *No patient effort* is displayed on the screen.

The *No patient effort* alarm can be audio delayed in Infant category only, see below.

If the patient triggers a breath, the ventilator automatically switches back to the supported mode.

The *No patient effort alarm* can be turned off in NAVA and NIV NAVA. See chapter Alarms on page 179.

APNEA AUDIO DELAY (INFANT ONLY)

The *Apnea audio delay* (silencing the *No patient effort alarm*) can be set in the *Alarm Profile* window.

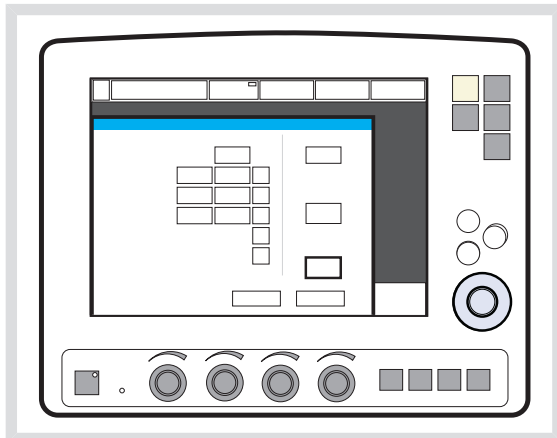

For apnea audio delay setting range, see section Alarm limits on page 231.

During backup ventilation the message *Alarm audio pause* is displayed on the screen.

NO CONSISTENT PATIENT EFFORT

No consistent patient effort is an alarm in invasive ventilation.

If the patient fulfils the criteria for the *No consistent patient effort* alarm, the ventilator will lock in backup ventilation.

A dialog *You are in Backup ventilation. Review ventilation settings or continue in support mode* is displayed on the screen. As long as this dialog is open no other menu window or dialog can be accessed. Only the Standby touchpad is active.

The user will be given the following choices:

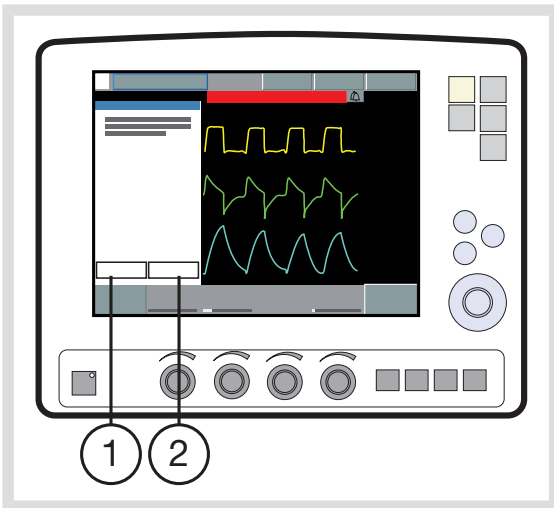

1. Review vent. settings
2. Continue in support mode

The ventilator will remain in backup ventilation until a choice is made.

The *No consistent patient effort alarm* can be turned off in NAVA. See chapter Alarms on page 179.

REVIEW VENTILATION SETTINGS

Press *Review vent. settings* in the *Backup ventilation* window to return to the *Set Ventilation Mode* window.

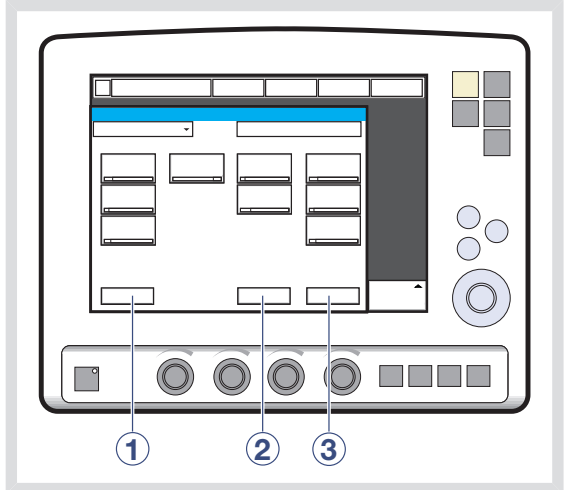

The following functions are available:

1. *Previous Mode* - recalls the previous accepted ventilation mode.
2. *Cancel* - closes the *Set Ventilation Mode* window without changes being applied, i.e. ventilation will continue as before.
3. *Accept* - accepts the settings and continues in the supported mode with reset apnea time.

CONTINUE IN SUPPORT MODE

Press *Continue in support mode* in the *Backup ventilation* window to continue in support mode. The apnea time will be reset.

6.15.2 DISABLING BACKUP VENTILATION

The backup ventilation can only be disabled in invasive ventilation.

It is possible either to enable or disable backup ventilation via the *Biomed* menu (this is possible in Pressure Support and Volume Support). If this choice is made, then an extra touchpad (*Backup ventilation*) (1), is displayed in the *Set Ventilation Mode* window during ventilation.

Note: It is only possible to deactivate backup ventilation when running, not in Standby.

To disable backup ventilation:

1. Press the *Backup ventilation* touchpad.
2. A confirmation dialog *Do you really want to deactivate backup ventilation?* is displayed. Confirm by pressing Yes.
3. *Backup ventilation off* is displayed on the *Ventilation mode* touchpad.
4. Press *Accept* in the *Set Ventilation Mode* window.

The backup function is automatically re-activated if the user:

- Changes to a controlled mode of ventilation.
- Sets the ventilator to Standby.
- Turns off the system.

Note: The backup ventilation remains inactive if the user changes mode between Pressure Support and Volume Support.

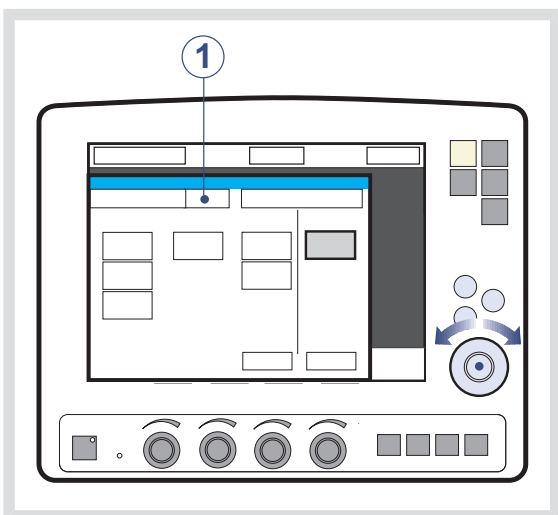

6.16 VENTILATORY PARAMETERS - OVERVIEW

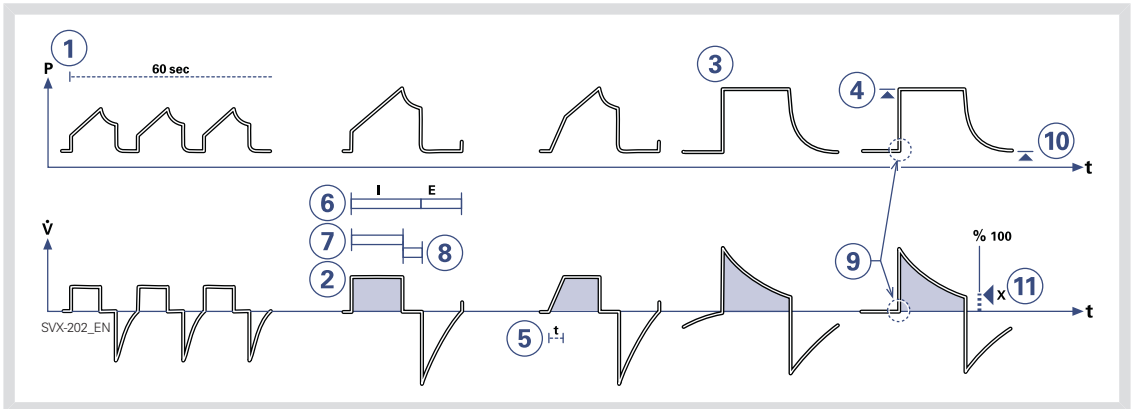

When a ventilation mode is selected, the only parameters shown are those affecting the actual mode. Below are all the mode-related parameters presented.

1. Respiratory rate (RR) Rate of controlled mandatory breaths or used for calculation of target volume (b/min).
2. Tidal volume (VT) Volume per breath or target volume (ml).
Minute volume (MV) Volume per minute or target Minute volume (ml/min or l/min). Presentation can be configured to either tidal or minute volume.
3. PC above PEEP Inspiratory pressure level for each breath (cmH₂O) in Pressure Control.
4. PS above PEEP Inspiratory pressure support level for triggered breaths (cmH₂O) in Pressure Support.
5. Inspiratory rise time (T_{insp. rise}) Time to full inspiratory flow or pressure at the start of each breath, as a percentage of the breath cycle time (%), or in seconds (s).
6. I:E ratio (I:E) (Inspiration time + Pause time): Expiration time.
7. Inspiration time (T_i) Time for active flow or pressure delivery to the patient (s).
8. Pause time (T_{pause}) Time for no flow or pressure delivery (% or s).
9. Trigger sensitivity
 - a. Below zero: Trigger sensitivity is pressure dependant. The pressure below PEEP which the patient must create to initiate an inspiration (cmH₂O) is indicated.
 - b. Above zero: Trigger sensitivity is flow dependent. As the dial is advanced to the right (step wise from the green into the red area) the trigger sensitivity increases i.e the inhaled fraction of the bias flow leading to triggering is reduced.
10. PEEP Positive End Expiratory Pressure (cmH₂O).
11. Inspiratory cycle-off Fraction of maximum flow at which inspiration should switch to expiration (%).

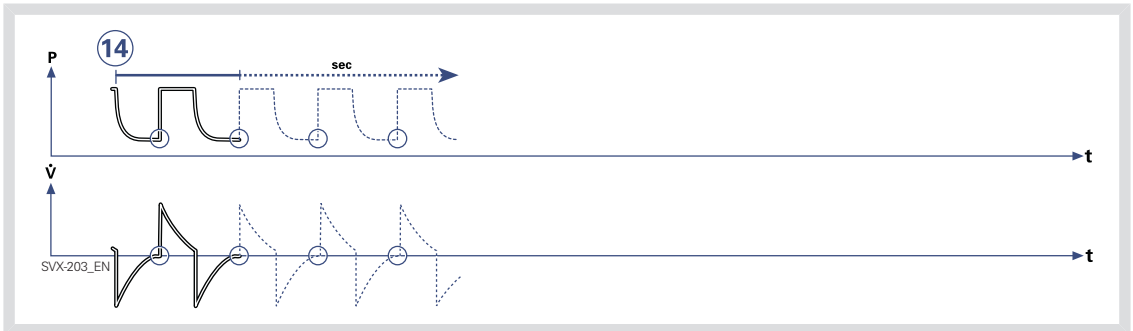
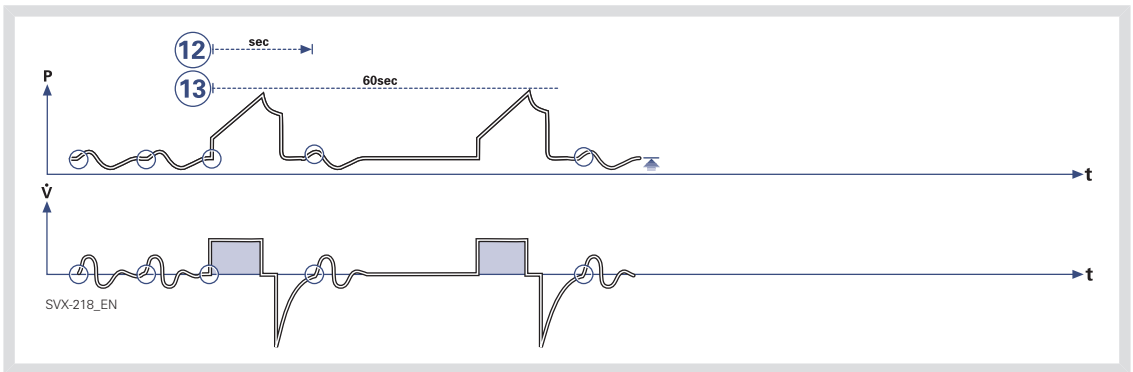

12. Breath cycle time (Breath cycle T) Total cycle time per mandatory breath in SIMV (inspiratory + pause + expiratory). Set in seconds.
13. SIMV rate Rate of controlled mandatory breaths (b/min).
14. Trigger timeout The maximum allowed apnea time in Automode, after which the system switches to controlled ventilation (s).

O₂ concentration (O₂ Conc.) O₂ concentration in inspiratory gas (not shown in the figure).

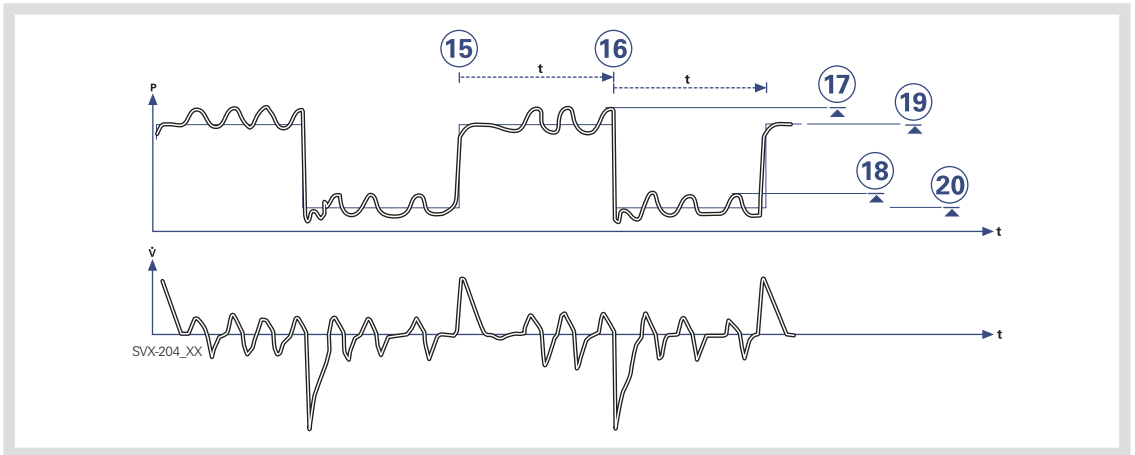

15. Time high (THigh) Time at PHigh level in Bi-Vent/APRV (s).
16. Time PEEP (TPEEP) Time at PEEP level in Bi-Vent/APRV (s).
17. Pressure Support above Pressure high (PS above PHigh) Inspiratory pressure support level for breaths triggered during the THigh period in Bi-Vent/APRV (cmH₂O).
18. Pressure Support above PEEP (PS above PEEP) Inspiratory pressure support level for breaths triggered during the TPEEP period in Bi-Vent/APRV (cmH₂O).
19. Pressure high (PHigh) Positive End Expiratory Pressure at the upper level in Bi-Vent/APRV (cmH₂O).
20. PEEP Positive End Expiratory Pressure at the lower level in Bi-Vent/APRV (cmH₂O).

6.17 SPECIAL FUNCTIONS

6.17.1 FIXED KEYS

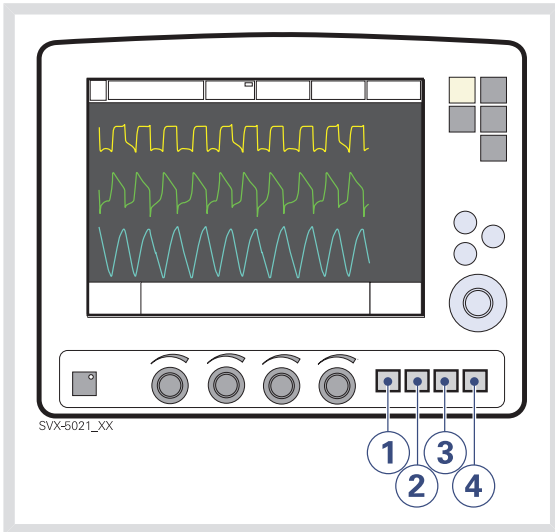

1. Start breath
2. O₂ breaths
3. Expiratory hold
4. Inspiratory hold

Can all be chosen by manually pressing the respective fixed key.

START BREATH

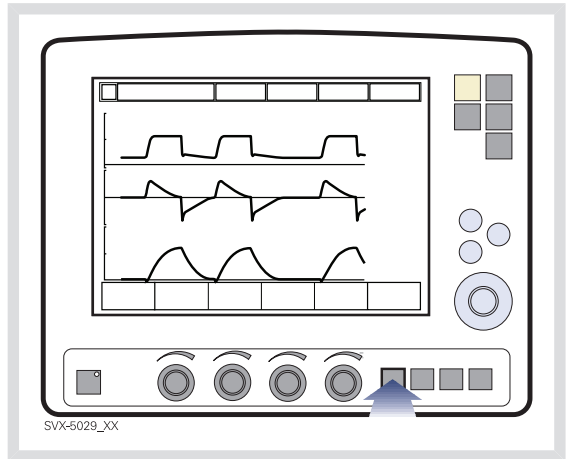

The ventilator will initiate a new breath cycle according to the current ventilator settings.

O₂ BREATHS

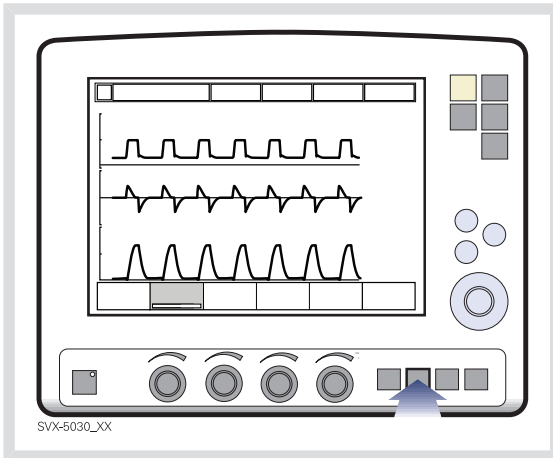

This function delivers 100% oxygen for 1 minute. After this time the oxygen concentration will return to the pre-set value. The oxygen breaths can be interrupted by repressing the O₂ breaths fixed key during the 1 minute interval.

EXPIRATORY HOLD

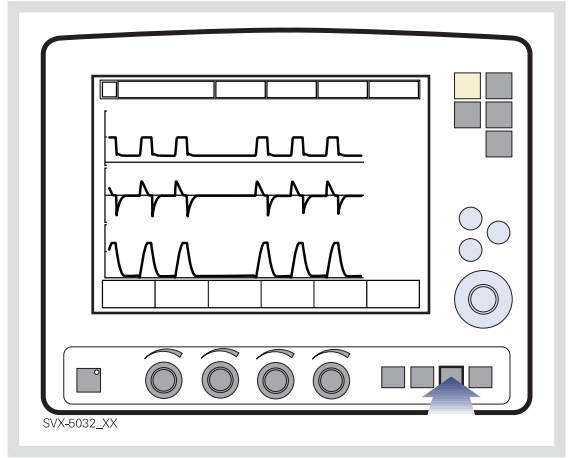

Expiratory and inspiratory valves are closed after the expiration phase is completed, for as long as the fixed key is depressed, up to a maximum of 30 seconds. Expiratory hold provides an exact measurement of the end expiratory pause pressure. It can be used to determine total PEEP and, together with inspiratory hold, static compliance. The dynamic pressure is shown on the PEEP numerical value.

INSPIRATORY HOLD

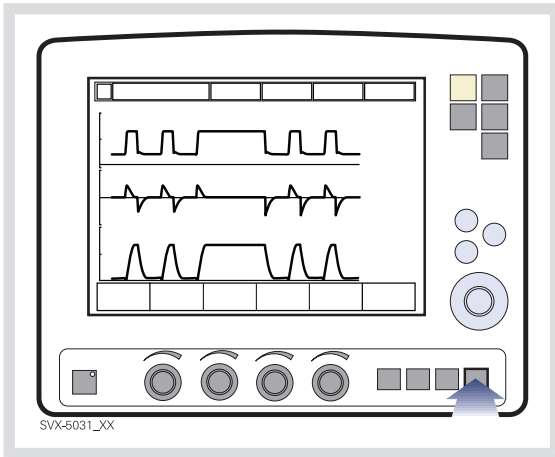

Inspiratory hold is activated by manually pressing the fixed key. The maximum time is 30 seconds. The inspiratory and expiratory valves close after inspiration. This function can provide an exact measurement of the end inspiratory lung pressure. It can be used during x-ray or to determine Plateau pressure, or, together with expiratory hold, calculate static compliance.

6.18 OPEN LUNG TOOL

The *Open Lung Tool* provides breath-by-breath graphical presentation of the following parameters:

- End inspiratory pressure
- PEEP
- VT
- Dynamic compliance
- Tidal CO₂ elimination (with CO₂ Analyzer - option)

Notes:

- The Open Lung Tool is not available in Bi-Vent/APRV, NAVA and NIV modes.
- When the Y Sensor Measuring (option) function is active, the values recorded in the Open Lung Tool are based on values measured at the Y Piece. When this function is disabled or enabled, the compliance in the patient circuit may cause the values in the Open Lung Tool to change.

6.18.1 USE THE OPEN LUNG TOOL

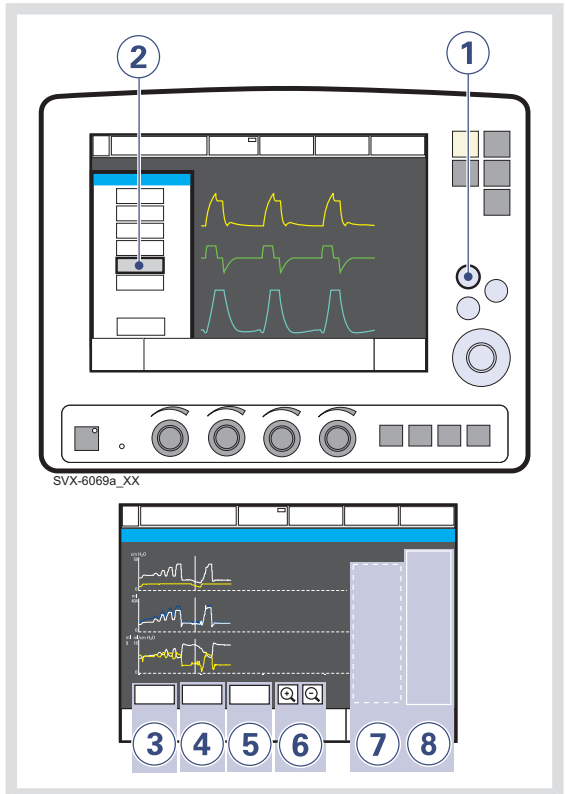

To use the Open Lung Tool:

1. Press the *Quick access* fixed key.
2. Press the *Open Lung Tool* touchpad.
3. Activate *Cursor Mode* by pressing the *Cursor* touchpad. Move the cursor using the Main Rotary Dial or touch screen.

Note: The cursor allows you to analyze the stored breath-by-breath data. When the *Cursor* touchpad is activated the cursor values will be shown in the value field.

- To clear all waveforms press the *Clear* touchpad.

Note: The *Clear* touchpad is not active in *Cursor Mode*.

- To close the *Open Lung Tool Window*, press the *Close* touchpad.
- Alter the resolution on the time axis.
- Cursor value field.
- Real-time value field.

Note: If additional windows such as loops are activated, the *Open Lung Tool Window* will be minimized and some function buttons will not be visible.

6.18.2 ADJUST SCALES IN OPEN LUNG TOOL DISPLAY

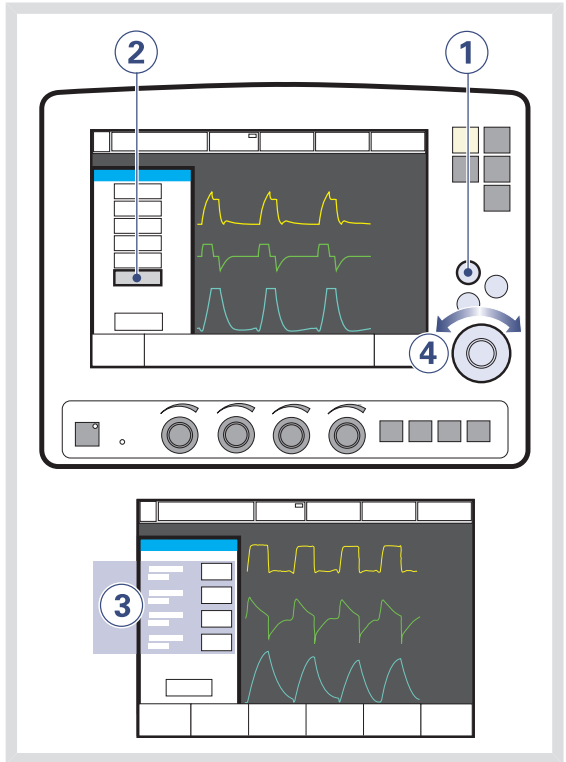

To set the amplitude for displayed waveforms:

- Press the *Quick access* fixed key.
- Press the *Open Lung Tool scales* touchpad.
- Press the touchpad corresponding to the waveform whose scale you want to adjust.
- Turn the *Main Rotary Dial* to the desired value.

Notes:

- When you reach a maximum allowed value, its display will flash.
- The time parameter displayed in the lower right corner of the user interface screen indicates how long it will take at the current settings for the waveform to complete one left-to-right sweep across the screen. Change the scaling with the zoom in/out function to speed up or slow down the screen-filling process.
- The breaths parameter displayed in the lower right corner of the user interface screen indicates the number of breaths at the current respiratory rate required for the waveform to fill the screen.

6.19 STRESS INDEX

6.19.1 DESCRIPTION OF STRESS INDEX

Stress index option is intended for adults only.

The Stress Index is continually calculated while ventilating in Volume Control mode or SIMV (VC) + PS. The value is displayed with two decimals.

Stress index is measured within a range of 0.5-1.5. A smaller range of 0.8-1.2 is displayed in the graph in the *Stress Index* window.

The Stress Index is displayed on the ventilator in the following ways:

- Numerically, as a value in the value list.
- Numerically and graphically in the Stress Index window.
- Graphed over time, i.e. a trend.

Notes:

- Calculations of the SI value requires a constant flow. Stress Index can not be calculated during *Volume Control with decelerating flow*.
- Calculations of the SI value requires stable controlled ventilation. Disturbances during transport can affect the calculations.
- The Stress Index is only calculated in Volume Control mode or in SIMV (VC) + PS. A message *Only available in VC and SIMV (VS) + PS* will appear if the user tries to open the window in other modes.
- When using SI, compliance compensation should be activated so that the user can keep track of the delivered tidal volume.

6.19.2 VALUE LIST

The measured Stress Index value is presented at the third page of the value list at the right of the screen. The text label is *SI*. The value is updated after every eighth breath.

The ventilator can be configured to also show the SI value on the first page of the value list via the *Biomed* menu.

6.19.3 STRESS INDEX WINDOW

It is possible to open a separate window which displays the calculated Stress Index value, along with a graph of recent values.

To display the Stress Index window:

- Press the *Quick access* fixed key.
- Press the *Stress Index* touchpad.

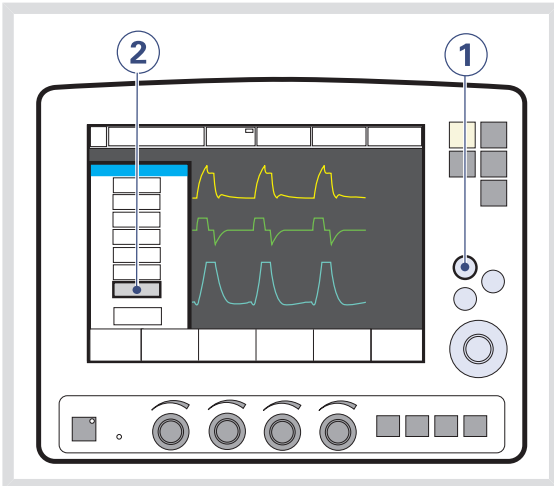

The window then appears as below:

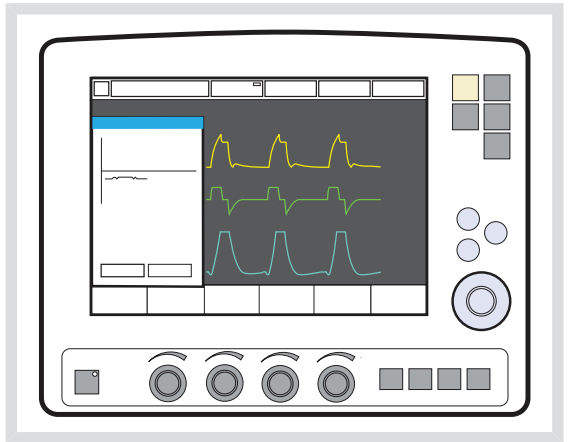

The graph and the displayed value are updated after every eighth breath.

CURSOR FUNCTION

- Press the *Cursor* touchpad to activate the cursor. Move the cursor using the *Main Rotary Dial*.

The cursor will indicate the point on the curve for the trended *SI*, *VTe* and *PEEP* values at the given time.

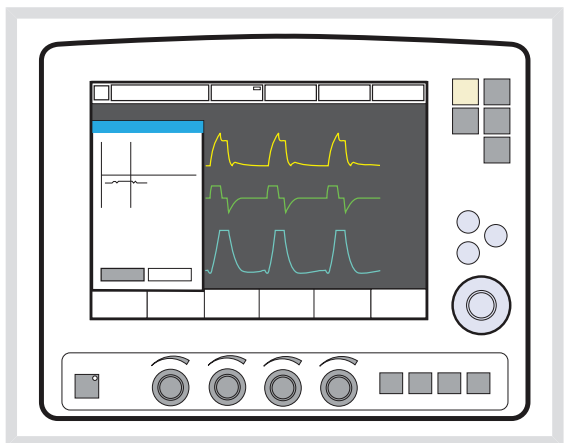

6.19.4 TREND

The Stress Index value is stored in the trend log. The value is sampled every minute for up to 24 hours.

To display the trends, press the fixed key *Trend*.

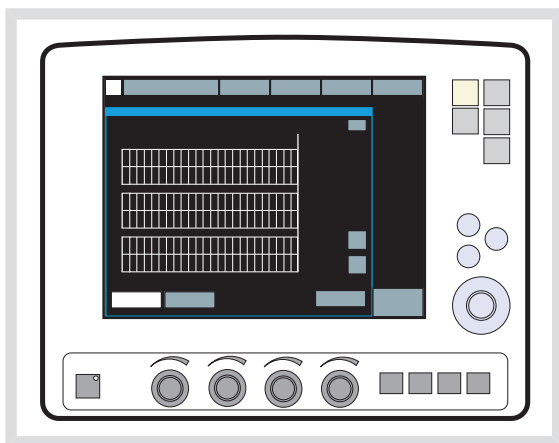

6.19.5 UNAVAILABLE STRESS INDEX

In Volume Control, it may sometimes be impossible to calculate the Stress Index. The displayed value will then be blank in both the value list and the *Stress Index* window. The value will not be recorded and the recorded graph will display a pause.

SI values that can be calculated but fall outside the allowed range will be displayed as “***” in the value list and *Stress Index* window. These values are recorded but will be displayed in the graph as a pause.

Values within the calculable range, but outside the graph’s display range, will be shown as dotted lines in the graph. All graph values can be accessed via the *Cursor* function in the *Stress Index* window.

The Stress Index value will be temporarily unavailable while breathing parameters are being changed, and occasionally if the patient’s breathing is so irregular that a value cannot be reliably calculated. Certain combinations of parameter values may also render it unavailable, and it will remain so until the combination is changed.

If Automode is selected, only controlled breaths will be included in the SI calculations. Breaths initiated by the patient will be discarded, and may in some cases render the SI value temporarily unavailable.

If the inspiratory time is less than 400 ms, a reliable calculation of the Stress Index cannot be performed and the message *Insufficient constant flow for SI* will be displayed.

6.20 HELIOX

6.20.1 GENERAL DESCRIPTION

A Heliox enabled SERVO-i Ventilator System compensates monitoring and flow delivery when HeO₂ is used. HeO₂ gas is connected to the SERVO-i Ventilator System via a Heliox adapter, which is connected to the Air/HeO₂ inlet. A pressure regulator is integrated in the Heliox adapter.

Four different Heliox adapters can be used with the SERVO-i Ventilator System:

- DISS (both Air and Heliox adapters)
- NIST/NIST
- AGA/NIST
- French/NIST

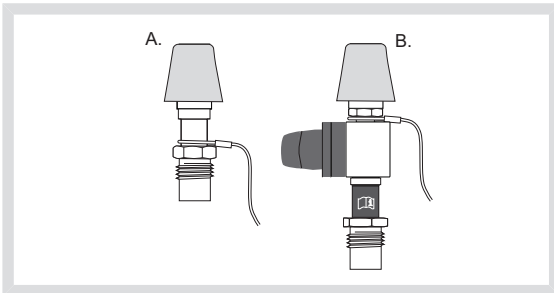

A. Air adapter DISS B. Heliox adapter DISS

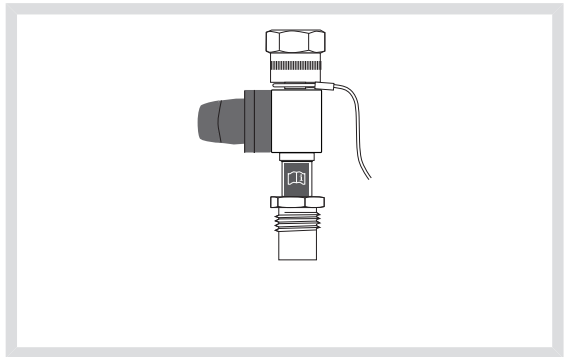

Heliox adapter (NIST/NIST)

The HeO₂ mixtures approved for the SERVO-i Ventilator System with the Heliox option are:

- Helium/Oxygen mixture 80:20
- Helium/Oxygen mixture 79:21
- Helium/Oxygen mixture 78:22

Mixing tolerance must not exceed $\pm 5\%$.
(i.e. ± 1 vol% O₂ in concentration)

AIR/HeO ₂	O ₂
AIR, O ₂ : 2.0 - 6.0 kPa x 100 (29 - 87 psi)	
HeO ₂ : Heliox adapter 	
V̇max 60 l/min	

The approved gas supply pressure applied to the Heliox adapter inlet is 3.4 - 6.0 kPa x 100 (49 - 87 psi).

6.20.2 WARNINGS, CAUTIONS AND IMPORTANT INFORMATION

WARNINGS!

- Always follow the policy and procedure of the hospital before starting Heliox treatment.
- Never use an HeO₂ gas which has an O₂ concentration of less than 20%.
- The Y Sensor is incompatible with HeO₂ and will be disabled when HeO₂ is used.
- The O₂-sensor is incompatible with Heliox option and will generate a technical alarm.
- Use only the MAQUET approved active humidifier F&P MR850 with HeO₂. Use of non-approved active humidifiers may result in higher gas temperatures and increase resistance in filters.
- During nebulization, there may be a higher deposition of drug used when HeO₂ is used instead of air.
- The Heliox supply hose shall be disconnected from the Heliox adapter or cylinder regulator before the cylinder is moved away from the ventilator.
- Additional patient monitoring (e.g. SpO₂, CO₂) is needed when ventilating patients in Infant patient category with a tidal volume below 100 ml due to reduced expiratory measurement accuracy.

CAUTIONS:

- Ensure that O₂ gas is always connected when HeO₂ is used with the SERVO-i Ventilator System.
- Do not remove the adapter(s) safety wire(s)

Important:

- When flow triggering is used and compensation for HeO₂ is made, then the sensitivity is automatically adjusted to a flow trigger level of 1 (if previously set to a higher level). This is done to avoid a self-triggering (auto-triggering) condition due to the different properties of HeO₂.
- The O₂ alarm limits are adjusted to $\pm 7\%$ O₂ when the system has been compensated for HeO₂.

Notes:

- When ventilating with HeO₂, the stabilization of expiratory measurements is delayed after the concentration of delivered O₂ is changed.
- Due to the lower density of HeO₂ compared to Air/O₂, the inspiratory flow in pressure controlled modes increases. In NIV this may shorten the inspiratory time.

6.20.3 CONNECTING HeO₂ TO THE SERVO-i VENTILATOR SYSTEM

The system is set up for Heliox usage as illustrated below.

Note: Ensure that the HeO₂ gas supply pressure is within specified range (3.4 - 6.0 kPa x 100 / 49 - 87 psi) before connecting the HeO₂ high pressure hose and Heliox adapter to the SERVO-i Ventilator System.

NIST, FRENCH AND AGA ADAPTERS

1. Remove the Heliox adapter from the holder and connect it to the HeO₂ high pressure hose.
2. Connect the Heliox adapter to the Air inlet.

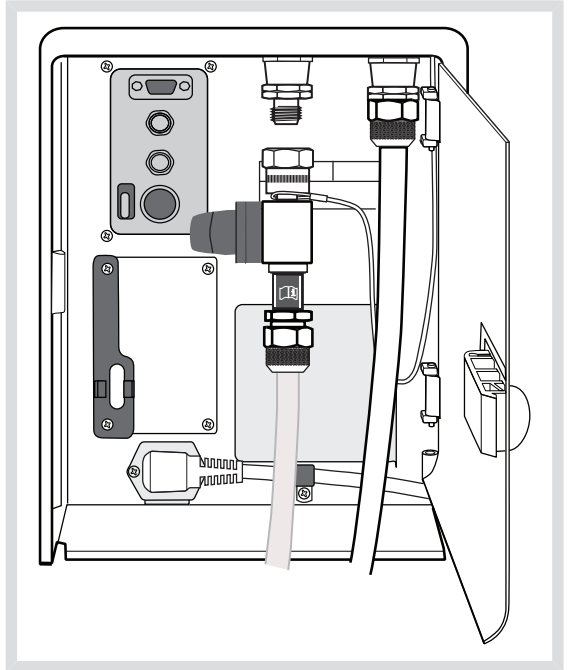

Connecting HeO₂ to the SERVO-i Ventilator System

DISS ADAPTERS

1. Connect the high pressure HeO₂ hose to the Heliox adapter.
2. Remove the air adapter from the Air/HeO₂ inlet of the ventilator.
3. Press the Heliox adapter onto the Air/HeO₂ inlet and place the air adapter onto the adapter holder.

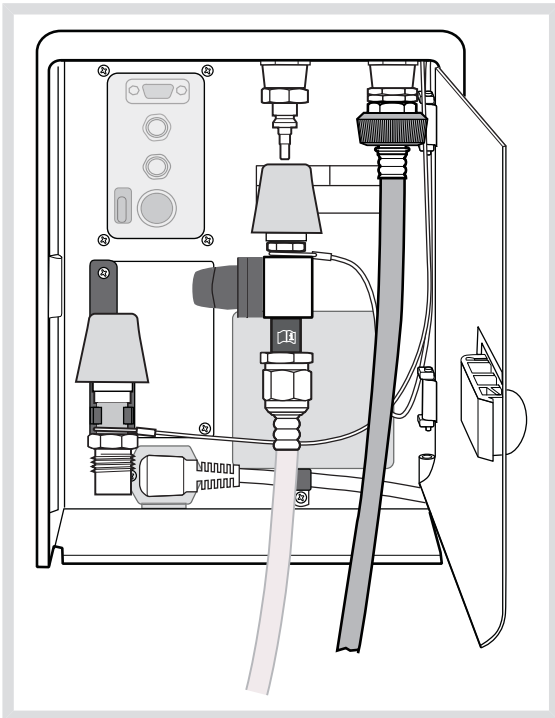

Connecting HeO₂ to the SERVO-i Ventilator System with air adapter DISS and Heliox adapter DISS

6.20.4 CHANGING GAS TYPE

You can change the gas type from air to HeO₂ and vice-versa both in Standby and during ventilation.

The instructions below show how to change from air to HeO₂, but the same procedure applies when changing from HeO₂ to air.

CHANGING FROM AIR TO HeO₂

1. Change the gas type by pressing:
Menu > Compensate > Gas type

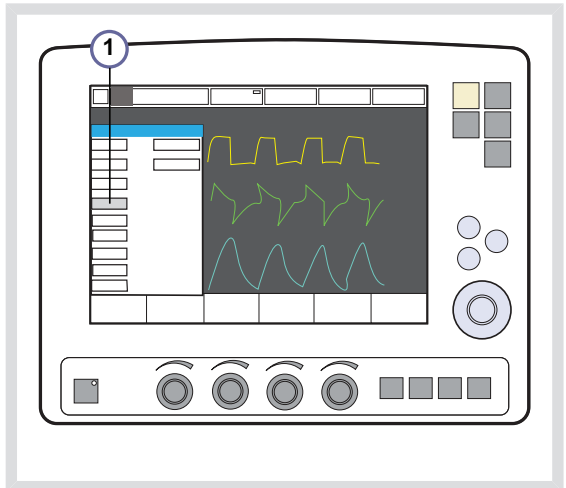

- The message *Make sure HeO₂ is connected before compensating. Do you really want to compensate for HeO₂?* Yes/No is displayed.

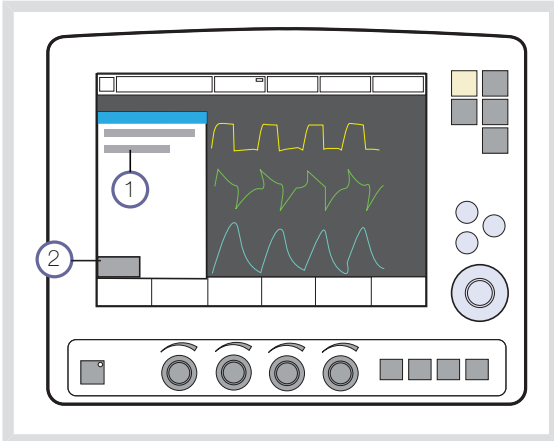

Note: Both the *O₂ concentration: High* and *Gas supply pressures: Low* alarms can be activated while changing gas during ventilation.

When changing gas type during ventilation, an automatic gas identification function is active.

If the ventilator identifies a mismatch between the gas selected manually and the gas connected to the system, then the message *HeO₂ not connected. System resets to Air compensation. Check gas supply.* is displayed (1).

- Remove the air supply and connect the Heliox adapter to the Air/HeO₂ inlet. Confirm the change by pressing Yes.
- The HeO₂ icon appears in the top left-hand corner of the screen, indicating that the system has been adjusted for HeO₂.
- Another message informs that the system has been compensated for HeO₂, that applicable adjustments have been made and that ventilator settings should be checked.
- To confirm press *OK*.

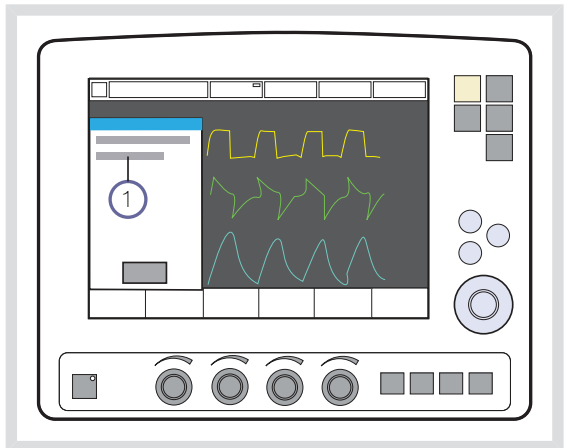

If more than one minute passes without the dialog being confirmed, then the alarm *Requested gas type not connected* is activated (2).

CHANGING FROM AIR TO HeO₂

1. Remove the air supply and connect the Heliox adapter to the Air/HeO₂ inlet.
2. When the ventilator identifies HeO₂, then the HeO₂ icon is displayed next to the patient category icon and a message informs that the system has been compensated for HeO₂, that applicable adjustments have been made and that ventilator settings should be checked.
3. To confirm press *OK* (2).

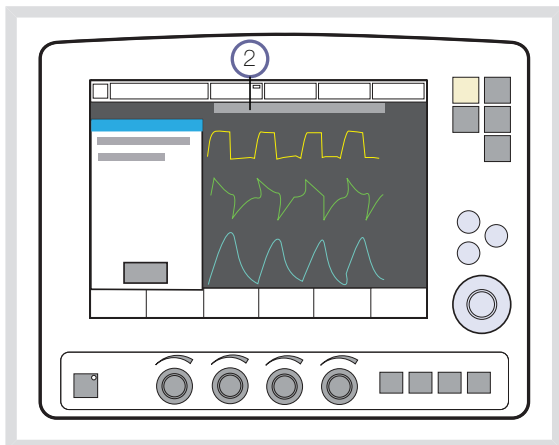

ALTERNATIVE PROCEDURE FOR CHANGING GAS DURING VENTILATION

The automatic gas identification function makes it possible to change gas during ventilation by simply changing the gas supplied to the ventilator.

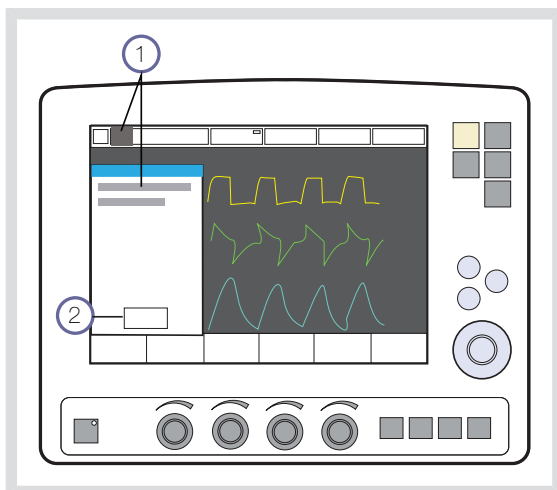

Notes:

- The time of automatic gas identification may be prolonged when there are low tidal/minute volumes and high O₂ concentrations.
- Automatic gas identification is disabled for set O₂ concentrations higher than 75%.
- When changing gas type from Air to HeO₂ or vice versa, the measured values on the screen relating to the expiratory flow may be affected for a short period of time.

7 NAVA

TABLE OF CONTENTS

7.1	Before use	152
7.2	System overview	153
7.3	Set up	157
7.4	Ventilate with NAVA	166
7.5	Ventilate with NIV NAVA	169
7.6	Neuro Ventilatory Tool	170

7.1 BEFORE USE

7.1.1 GENERAL DESCRIPTION

NAVA and NIV NAVA ventilation delivers ventilatory assist in proportion and synchronized to the patient's Edi (the electrical activity of the diaphragm). The Edi waveform is also available in other ventilation modes for monitoring the patient's own breathing efforts as well as in Standby.

7.1.2 PATIENT CATEGORIES

NAVA and NIV NAVA can be used on all patients who require ventilatory assistance (neonatal, pediatric and adult patients).

7.1.3 WARNINGS, CAUTIONS AND IMPORTANT INFORMATION

WARNINGS!

- The Edi Catheter and guide wire are for single use only. Reprocessing will degrade biocompatibility and/or cleanliness. Each Edi Catheter may be used for up to 5 days.
- The Edi Catheter must be removed from the patient before an MR examination. Due to the metallic electrodes:
 - The strong magnetic and RF fields could generate heat in the electrodes.
 - Artifacts (distortions) may appear in the MR images.

Important:

- Ensure that the electrical connector on the Edi Catheter does not get wet. This may result in degradation of the function.

- The feeding lumen of the Edi Catheter is slightly smaller compared to the feeding lumen of a standard feeding tube of the same size; this must be taken into consideration especially for Edi catheters 6 and 8 Fr.
- When ventilating patients weighing less than 3 kg in NIV NAVA, external monitoring (e.g. SpO₂ or CO₂) is required.
- In NIV NAVA, small tidal volumes in combination with high leakage reduce the accuracy of expiratory measurements.

Notes:

- External equipment (e.g. heating blankets) may cause disturbances in the Edi signal.
- Continuous movement of the Edi Catheter (e.g. against another person's body when holding the baby in kangaroo position) may cause disturbances in the Edi signal.
- Be observant when using NAVA ventilation on patients with implanted defibrillators since this device may interfere with Edi signals when activated.
- All disposable parts must be discarded according to hospital routines and in an environmentally safe way.

7.2 SYSTEM OVERVIEW

Electrical activity in the diaphragm precedes mechanical contraction of the diaphragm muscle.

By inserting an Edi Catheter into the esophagus to the gastric ventricle the electrical activity can be monitored.

7.2.1 Edi CATHETER

The Edi Catheter is a single-use feeding tube with measuring electrodes.

It is positioned in the esophagus so that the set of measuring electrodes spans the path of movement of the diaphragm.

7.2.2 SYSTEM COMPONENTS

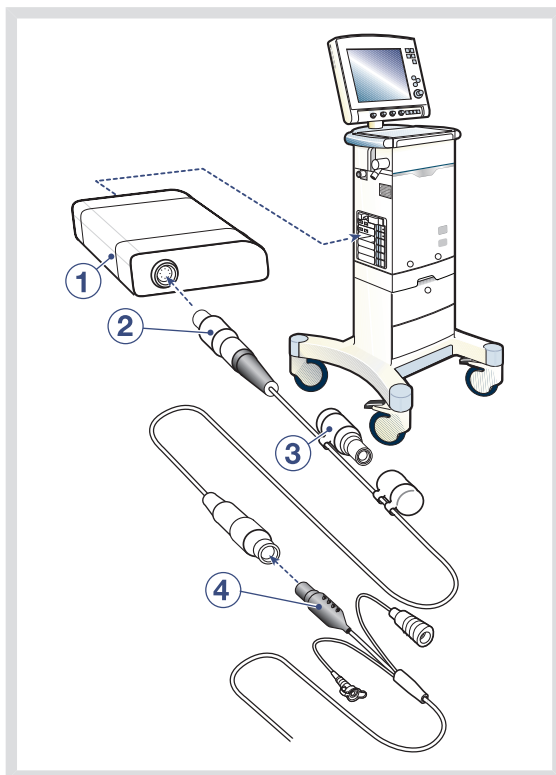

The Edi interchangeable plug-in Module slots into the module compartment in the SERVO-i Ventilator System:

- Edi Module (1).
- Edi Cable (2).
- Edi Test Plug (3).
- Edi Catheter (4).

7.2.3 FUNCTIONAL DESCRIPTION

NAVA and NIV NAVA are patient initiated breathing modes in which the breathing support is triggered by the electrical activity of the diaphragm (Edi).

During NAVA ventilation the patient controls the respiratory rate and the tidal volume with the assist from the ventilator.

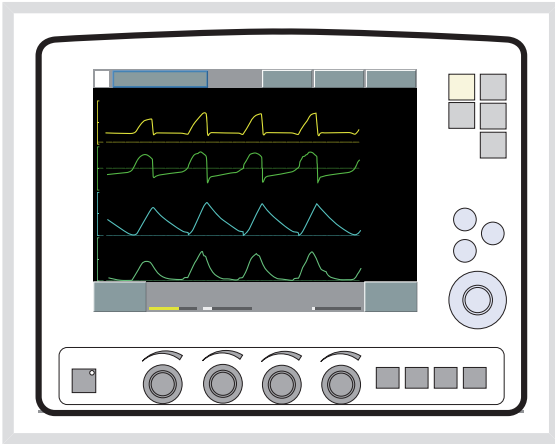

The operator sets the NAVA level. The higher the NAVA level is set, the more assist is given to the patient.

This NAVA level value is multiplied by the measured Edi signal to provide a set pressure for the delivered gas.

NAVA:

Edi x NAVA level = gas pressure delivered, above PEEP.

For example:

$$5 \mu\text{V} \times 3 \text{ cmH}_2\text{O}/\mu\text{V} = 15 \text{ cmH}_2\text{O} \text{ (above PEEP)}$$

NIV NAVA:

Edi x NAVA level + 2 cmH₂O = gas pressure above PEEP.

For example:

$$5 \mu\text{V} \times 3 \text{ cmH}_2\text{O}/\mu\text{V} + 2 \text{ cmH}_2\text{O} = 17 \text{ cmH}_2\text{O} \text{ (above PEEP)}$$

The set pressure varies during the entire inspiration due to the Edi variation, but is limited to 5 cmH₂O below the set upper pressure limit in *Alarm profile* window.

If three consecutive breaths are limited, a message will be presented on the screen.

Important:

- Set upper pressure alarm limit.
- Set lower and upper alarm limits for expired Minute Volume and Respiratory Rate.

During the expiratory phase, the Edi does not influence the ventilation, therefore the operator should set an appropriate PEEP value.

Should the ventilator fail to trigger on Edi, but trigger on pneumatic criteria e.g., if the Edi Catheter moves out of position, there is a guaranteed level of 2 cmH₂O for all triggered breaths (cannot be changed).

See Backup Ventilation on page 127.

7.2.4 RESPIRATION CYCLE

Inspiration starts:

When the patient triggers a breath gas flows into the lungs at a varying pressure proportional to the patient's Edi.

Expiratory phase starts:

- When the Edi decreases below 70% of the peak value (during the ongoing inspiration).
- If the pressure increases 3 cmH₂O above the inspiratory target pressure.
- If the upper pressure limit is exceeded.

The maximum time for inspiration is:

- Infant 1.5 seconds
- Adult 2.5 seconds

The Edi signal can also be displayed when ventilatory modes other than NAVA mode are used as well as in Standby. The Edi signal will then be used to monitor synchrony and patient efforts enabling the user to manually fine-tune the ventilator settings or to monitor when the Edi returns after pharmaceutical blocking.

7.2.5 NAVA PARAMETERS

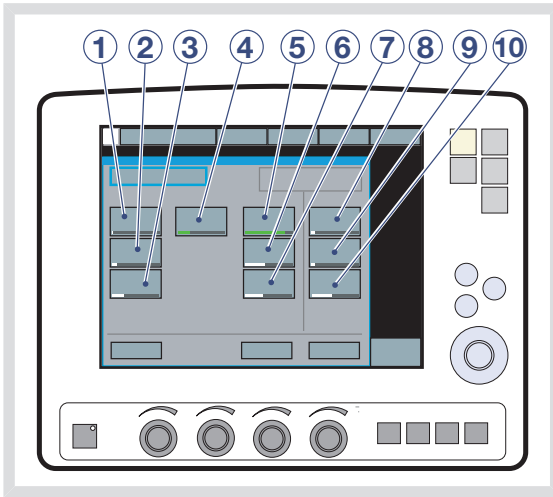

The following parameters are set:

1. NAVA level: The relation between measured Edi signal and pressure assist provided. (cmH₂O/μV)
2. PEEP (cmH₂O)
3. Oxygen concentration (%)
4. Trigg. Edi: The predefined level that the Edi signal has to reach to start a new inspiration. Too low a value may give extra undesired breaths. Too high a value may result in missed inspirations. (μV)
5. Pneumatic trigger (flow or pressure)
6. Pneumatic inspiratory Cycle-off (%)
7. PS (Pressure Support level) above PEEP (cmH₂O)
8. PC (Pressure Control level) above PEEP (cmH₂O) in backup ventilation
9. Resp. Rate in backup ventilation
10. I:E / Ti in backup ventilation (depending on configuration)

7.2.6 NIV NAVA PARAMETERS

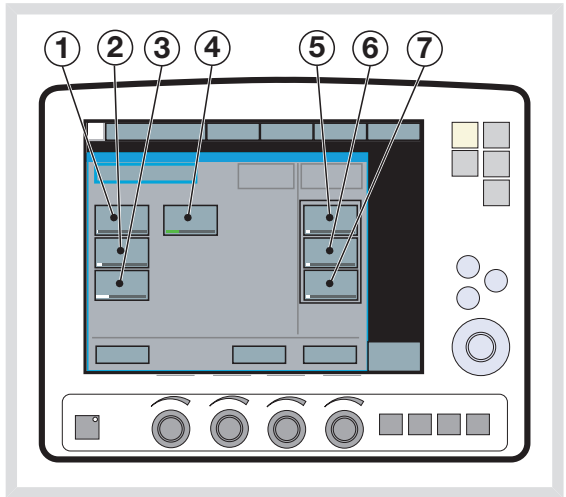

The following parameters are set:

1. NAVA level: The relation between measured Edi signal and pressure assist provided. (cmH₂O/μV)
2. PEEP (cmH₂O)
3. Oxygen concentration (%)
4. Trigg. Edi: The predefined level that the Edi signal has to reach to start a new inspiration. Too low a value may give extra undesired breaths. Too high a value may result in missed inspirations. (μV)
5. PC (Pressure Control level) above PEEP (cmH₂O) in backup ventilation
6. Resp. Rate in backup ventilation
7. I:E / Ti in backup ventilation (depending on configuration)

7.3 SET UP

Important:

- As soon as the Edi Catheter position is checked and verified, it is important to attach the Edi Catheter securely to the patient.
- The patient must have an intact respiratory drive. Both hyperventilation and muscle relaxants can inhibit diaphragm activity and prevent NAVA ventilation: the Edi Catheter can stay in place until the Edi is re-established (when the relaxant effects have worn off or the Pressure Support or Volume Support level has been lowered), and it is possible to ventilate with NAVA.

7.3.1 WORKFLOW

Notes:

- Always perform a visual inspection of the equipment before use.
- The patient will already be ventilated by SERVO-i Ventilator System in a conventional mode.

1. Insert Edi Module and Edi Cable into SERVO-i Ventilator System, as shown on page 158.
2. Test the Edi Module and the Edi Cable with the test plug, as shown on page 158.
3. Select the correct Edi Catheter size for the patient according to the package labelling.
4. Estimate the length of Edi Catheter to be inserted into the patient, as shown on page 159.
5. Dip the Edi Catheter in water momentarily, as shown on page 160.
6. Insert Edi Catheter into the patient to estimated length, as shown on page 160.
7. Plug the Edi Catheter Cable connector into the Edi Cable.
8. Position the Edi Catheter according to the procedure described on page 161.
9. Check the position of the Edi Catheter as a feeding tube according to hospital guidelines. Secure as described on page 163.
10. Set the initial NAVA level with the help of the NAVA preview tool, as shown on page 165.
11. Select NAVA or NIV NAVA, set the ventilation and backup parameters and start ventilating.
12. Check that the cables are safely positioned.

7.3.2 INSERT Edi MODULE INTO PATIENT UNIT

Important: If the Edi Module is dropped on the floor a leakage current check must be performed.

Note: Do not insert two Edi modules at the same time. The SERVO-i Ventilator System can only handle one Edi module at a time.

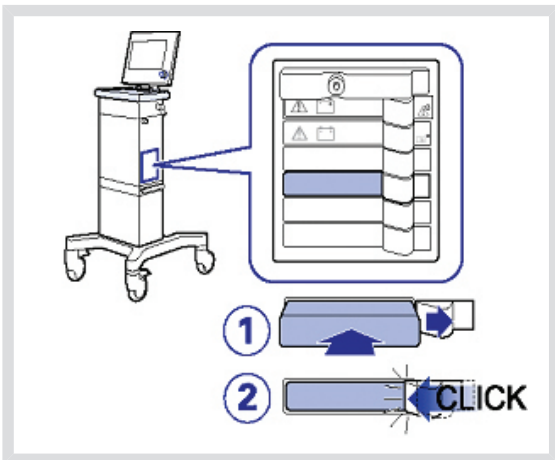

To insert the Edi Module:

1. Insert the Edi Module into a free slot in the module compartment on the Patient Unit.
2. Make sure it clicks into place.

When required, the Edi Module can be removed by pushing the lock handle aside and sliding out the module.

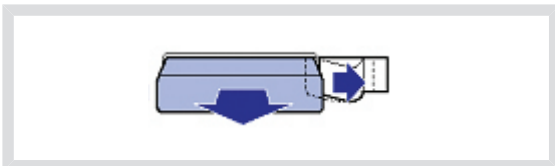

7.3.3 Edi MODULE FUNCTION CHECK

1. Connect the Edi Cable to the Edi Module: hold the ribbed part of the connector (white marks to the right) and insert into the socket.

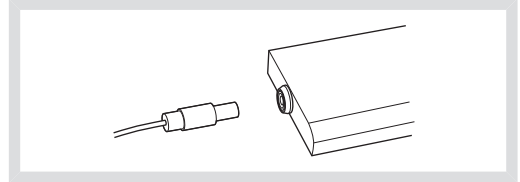

2. Remove the cap from the test plug and connect the test plug to the other end of the Edi Cable. The Edi Module test will then start automatically.
3. Wait until the dialog 'Edi Module test passed' shows on the display.
 - If the test fails, replace the Edi Cable and/or Edi Module and re-run the test. To remove the Edi Cable hold the ribbed part of the connector and pull gently to release.

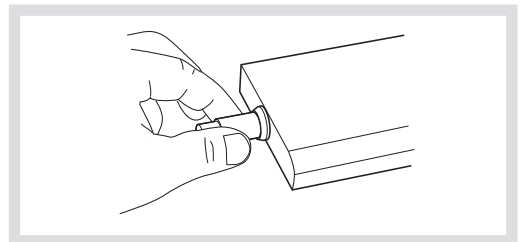

4. Press OK, remove the test plug and replace the cap.

7.3.4 BEFORE INSERTING THE Edi CATHETER

Important:

- Always use the correct Edi Catheter size for the patient.
- The feeding lumen of the Edi Catheter is slightly smaller compared to the feeding lumen of a standard feeding tube of the same size; this must be taken into consideration especially for Edi catheters 6 and 8 Fr.

Note: Follow hospital hygiene routines for handling nasogastric tubes when handling the Edi Catheter. The Edi Catheter is packed sterile.

1. Select the correct Edi Catheter size for the patient according to the package labelling.
Verify, by visual inspection, that the package and the Edi Catheter are undamaged.
2. Measure the distance from the bridge of the Nose (N) via the Earlobe (E) to the Xiphoid process (X). This is referred to as the NEX measurement.

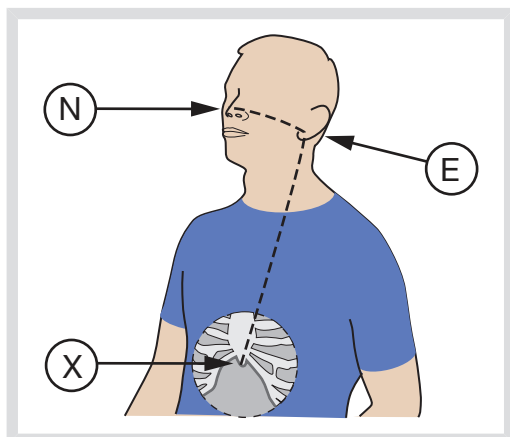

3. Note down the NEX measurement in centimetres, then calculate Y:

For nasal insertion multiply the NEX value by 0.9 and add the extra centimetres as shown here:

Edi Catheter size	Insertion length Y
16 Fr	$(\text{NEX} \times 0.9) + 18 = Y \text{ cm}$
12 Fr	$(\text{NEX} \times 0.9) + 15 = Y \text{ cm}$
8 Fr 125 cm	$(\text{NEX} \times 0.9) + 18 = Y \text{ cm}$
8 Fr 100 cm	$(\text{NEX} \times 0.9) + 8 = Y \text{ cm}$
6 Fr 50 cm	$(\text{NEX} \times 0.9) + 3.5 = Y \text{ cm}$
6 Fr 49 cm	$(\text{NEX} \times 0.9) + 2.5 = Y \text{ cm}$

For oral insertion multiply the NEX value by 0.8 and add the extra centimetres as shown here:

Edi Catheter size	Insertion length Y
16 Fr	$(\text{NEX} \times 0.8) + 18 = Y \text{ cm}$
12 Fr	$(\text{NEX} \times 0.8) + 15 = Y \text{ cm}$
8 Fr 125 cm	$(\text{NEX} \times 0.8) + 18 = Y \text{ cm}$
8 Fr 100 cm	$(\text{NEX} \times 0.8) + 8 = Y \text{ cm}$
6 Fr 50 cm	$(\text{NEX} \times 0.8) + 3.5 = Y \text{ cm}$
6 Fr 49 cm	$(\text{NEX} \times 0.8) + 2.5 = Y \text{ cm}$

4. Note down the calculated value for the Edi Catheter insertion length Y in centimeters.

7.3.5 INSERT THE Edi CATHETER

WARNING! Never re-insert or manipulate the guide wire once the Edi Catheter has entered the patient, otherwise the guide wire may penetrate a feeding hole.

Important:

- Do **not** apply any other substance than water to the Edi Catheter. Lubricants, gels or solvents may destroy the coating and the contact with the electrodes.
- When the Edi Catheter is inserted into the esophagus, do not insert any other probe or feeding tube.
- If a guide wire is used, only use a wire from Maquet.

Note: Make sure that the connector cannot hurt the patient; be aware of the distance from patient to connector and possible fixation of connector.

1. Dip the Edi Catheter in water for a few seconds to activate its lubrication prior to insertion, avoiding wetting the connectors.

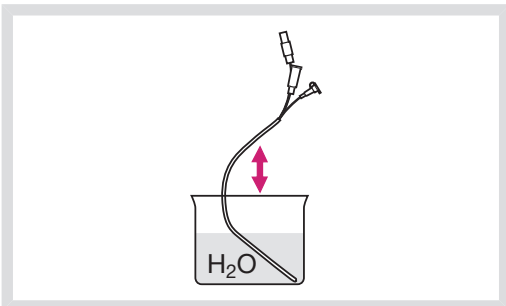

2. Insert the Edi Catheter and advance it down the esophagus to the calculated Y length.

Nasal insertion:

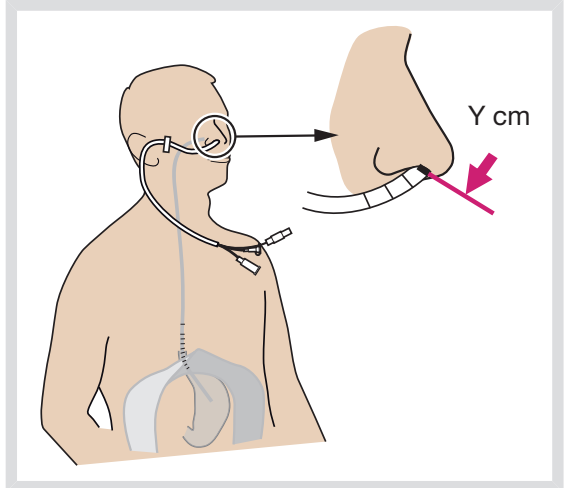

Oral insertion:

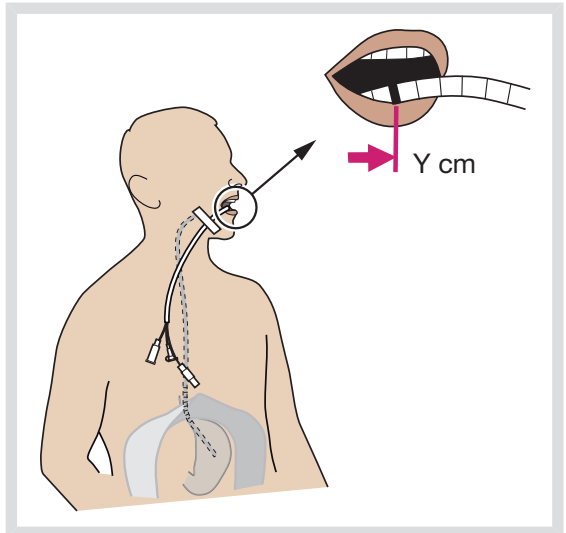

7.3.6 POSITION THE Edi CATHETER

1. Connect the Edi Catheter to the Edi Cable. Remove the cap from the Edi Catheter, hold the connector and plug it into the Edi Cable connector.

Note: To prevent contamination of the Edi Catheter cable connector, always keep the protective cap on the connector when it is not connected to the ventilator.

If already four waveforms are shown on the screen, the Volume curve will automatically be replaced by the Edi curve.

2. Open the Neural access menu using the *Neural access* (1) fixed key.

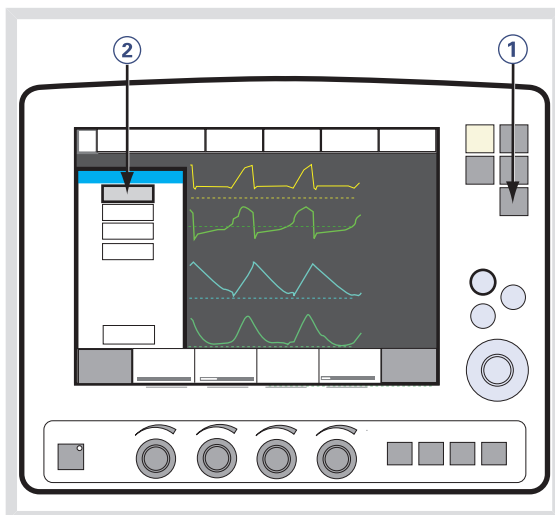

3. Select Edi Catheter positioning (2).

The Edi Catheter positioning window opens:

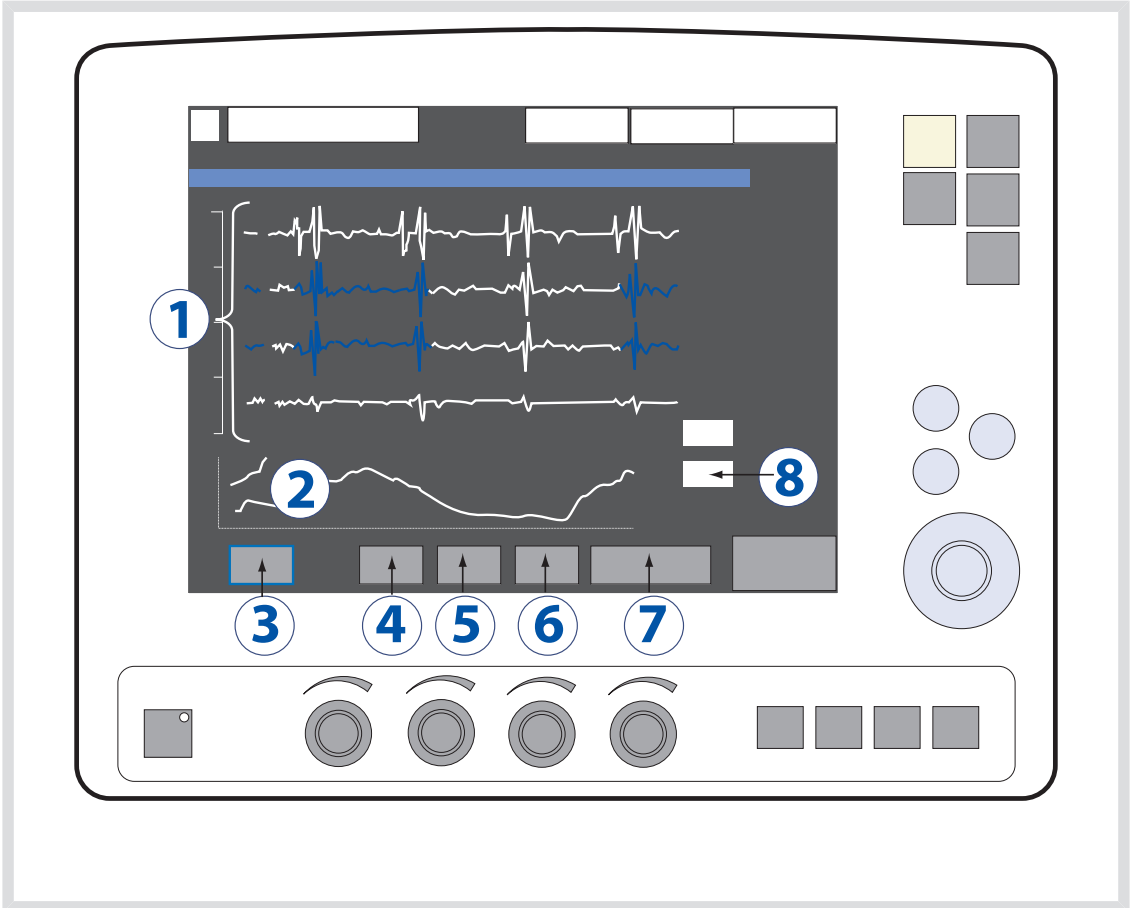

1. ECG leads
Blue segments indicate the leads with the strongest *Edi* signals.
2. Edi curve
3. Freeze; freezes the screen image
4. Leads scale (auto, 10 - 200)
5. Edi scale (auto, 5 - 200)
6. Sweep speed (5 - 40 mm/s)
7. Close window
8. Numeric values of the Edi peak and Edi minimum values

4. Check the position of the Edi Catheter by means of the ECG waveforms:

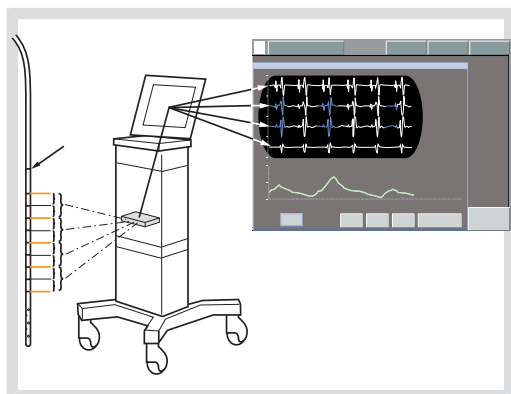

- Verify that the P and QRS waves are visible on the top leads, and that the P waves disappear and the QRS wave amplitude decreases on the lower leads.
 - Verify that the Edi scale is fixed and set to 20 μV . Set a sufficiently high upper limit on the scale where the Edi signal is not fully visible.
 - If the Edi deflections are present, observe which leads are highlighted in blue.
 - If the leads highlighted in blue are in the center during an inspiration, i.e. second and third leads, then the Edi Catheter is aligned correctly and ready to be secured.
5. If not already aligned then adjust the Edi Catheter position:
 - If the top leads are highlighted in blue, pull out the Edi Catheter in steps corresponding to the IED, until the blue highlight appears in the centre. Do not exceed 4 IED steps.
 - If bottom leads are highlighted in blue, insert the Edi Catheter further in steps corresponding to the IED, until the blue highlight appears in the center. Do not exceed 4 IED steps.
 6. Before securing, take up the slack very gently in the Edi Catheter.
 7. Note the actual length inserted, in the patient's journal and mark on the Edi Catheter.
 8. Secure the Edi Catheter well, being careful not to manipulate or move it in order to avoid interference (of Edi monitoring).

Edi Catheter size	Inter Electrode Distance, IED
16 Fr	16 mm
12 Fr	12 mm
8 Fr 125 cm	16 mm
8 Fr 100 cm	8 mm
6 Fr 50 cm	6 mm
6 Fr 49 cm	6 mm

9. Check the Edi curve at the bottom of the positioning window.

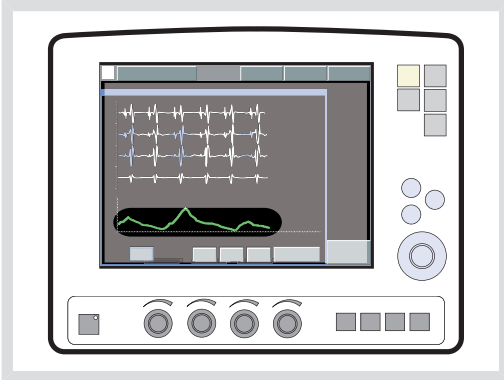

If low or no Edi activity is observed:

- Verify that the effects of muscle relaxants have worn off.
 - Verify the patient's sedation level. The apneic threshold might be higher due to CNS depressant drugs.
 - Verify, by blood gas or end tidal CO₂, that the patient is not hyperventilated, as this may affect the Edi signal, e.g if the Pressure Support or Volume Support level is too high.
10. Check the position of the Edi Catheter as a feeding tube according to hospital guidelines.

Note: If the Edi is not synchronized with pressure and flow, this may mean that the Edi Catheter is displaced and registering the electrical activity of another muscle. This will be indicated by the Pneumatic-Edi out of synch alarm for NAVA.

Important:

- Never switch to NAVA ventilation if the Edi deflection is out of sync with the pressure and flow.
- When not in use, it is recommended that the feeding lumen is covered in order to avoid incorrect use.
- If the Edi Catheter is not connected to the ventilator system, do not touch the Edi Catheter connector during defibrillation.

7.3.7 SET NAVA LEVEL

- Set the alarm limits to relevant values to provide adequate patient safety.
- Never switch to NAVA ventilation if no Edi activity is observed.

1. Press the *Neural Access* fixed key.
2. Select NAVA preview.
3. On the uppermost waveform, there are two curves presented simultaneously. The gray curve shows the estimated pressure P_{est} based on Edi and the set NAVA level. The yellow curve is the current patient pressure.
4. Press the NAVA level button and use the Main rotary dial to set the NAVA level. Press the NAVA level button a second time to save the NAVA level. The NAVA level will be transferred to the NAVA ventilation mode window.
5. To close the window, press *Close*.

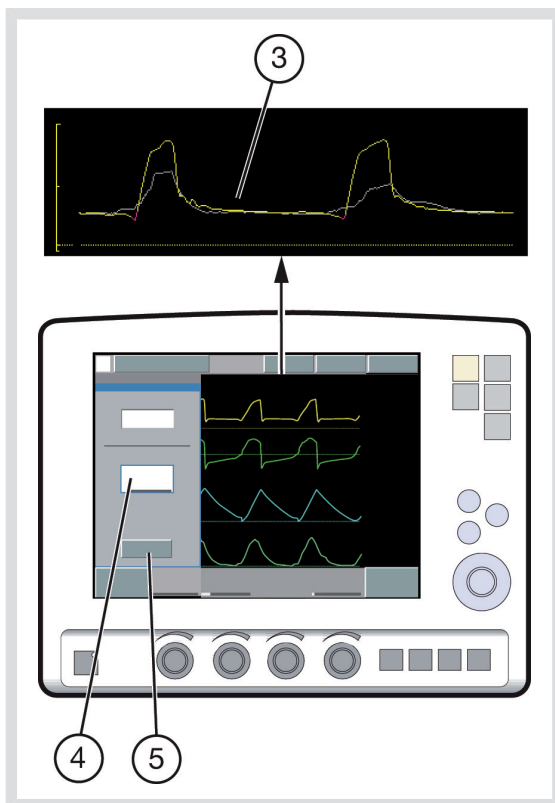
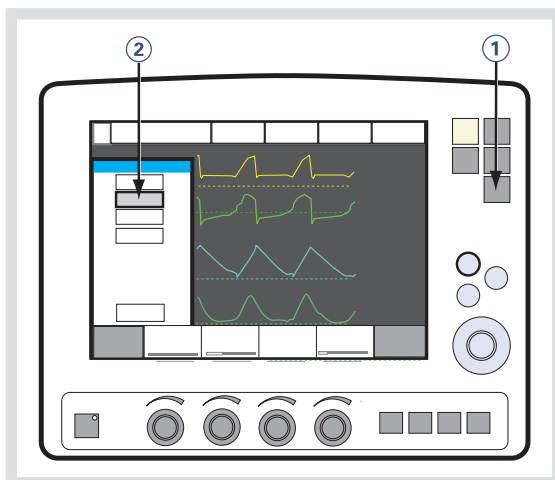

7.4 VENTILATE WITH NAVA

7.4.1 SET UP AND START VENTILATION

Important: Before switching to NAVA / NIV NAVA ventilation, all settings including backup settings must be set to achieve adequate ventilation.

1. Open the *Select Ventilation Mode* window.
2. Choose *NAVA*.

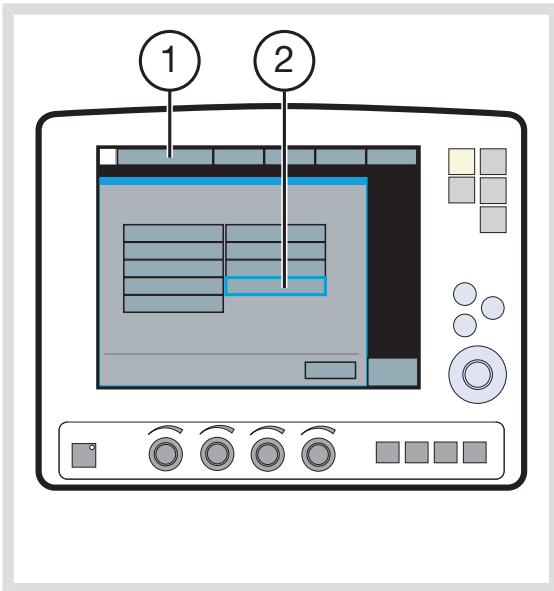

3. The *Set Ventilation Mode* parameters window opens.

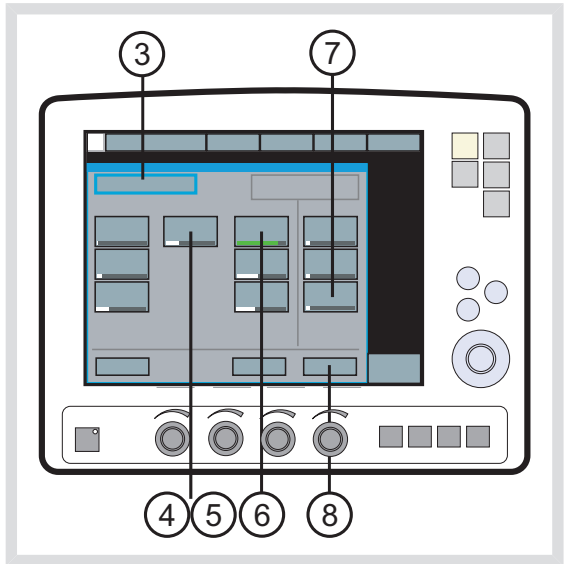

4. There are three basic settings: NAVA level, PEEP, and O₂ conc. The initial NAVA level has been set. Use adequate values for PEEP and O₂ conc.
5. The Trigg. Edi can be set between 0.1 and 2.0 μV . Default is 0.5 μV and rarely needs to be changed. The Edi trigger level may be varied to avoid noise in the Edi signal. The trigger is shown with a symbol and a color mark on the waveform.
6. Pressure support: select values for Pneumatic trigger, Insp. cycle off, and Pressure Support level.
7. Backup ventilation: select the Pressure, Resp. Rate and I:E / Ti backup levels to achieve adequate ventilation in case of apnea.

See *Backup Ventilation* on page 127.

8. Select *Accept* to accept the settings and proceed with NAVA ventilation.

If you select *Cancel* the Set NAVA Ventilation Mode window will close without changes being implemented. i.e. ventilation will continue as before.

7.4.2 PNEUMATIC-Edi OUT OF SYNCH ALARM (NAVA ONLY)

Check for possible causes of asynchrony when the system activates a Pneumatic-Edi out of synch alarm.

Check:

- Edi signal
- Catheter position
- Pneumatic trigger setting
- Edi trigger setting

The window will disappear when adequate corrections are made. If the alarm remains select *Back to NAVA* (1) or *Change mode* (2).

BACK TO NAVA

Important: Make sure that there is no asynchrony before using *Back to NAVA*.

- A. Press Back to NAVA (1) to switch from NAVA (PS) to NAVA.
- B. Select Yes (3) to change to NAVA. Select No (4) to return to ventilation in NAVA (PS).

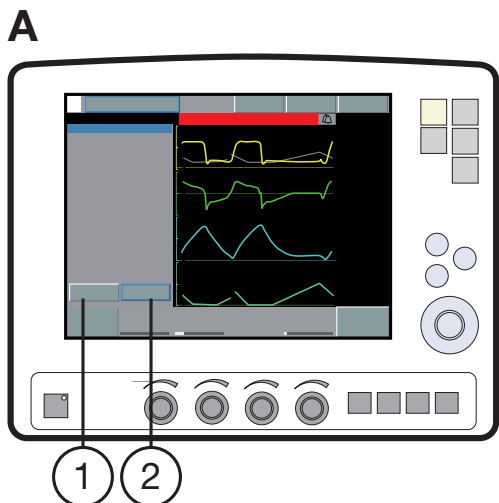
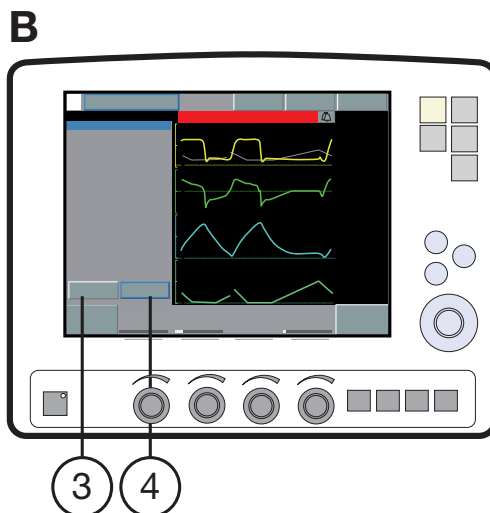

CHANGE MODE

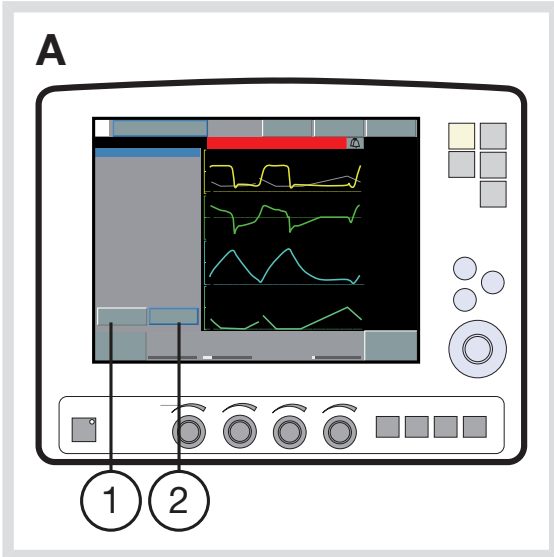

- A. Select *Change mode* (2) to open the *Set ventilation mode* window.
- B. Select a new ventilation mode and press *Accept* (5). Press *Previous Mode* (6) to return to the mode set before NAVA.

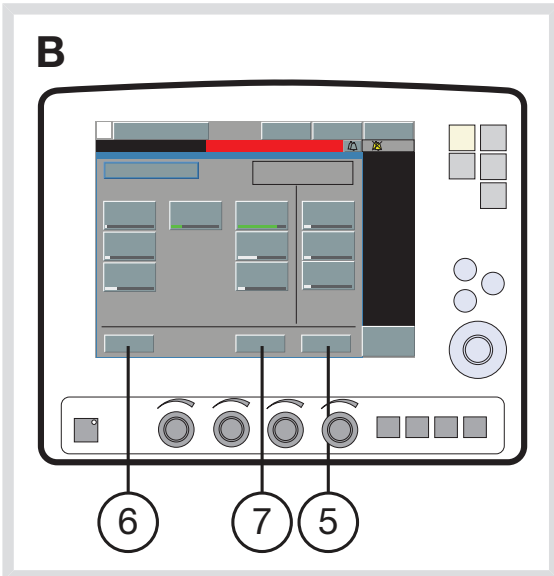

Note: If the *Accept* button is pressed without a new ventilation mode being set, the system returns to the *Pneumatic-Edi out of synch* window and to NAVA (PS).

The system returns to the *Pneumatic-Edi out of synch* window if *Cancel* (7) is pressed.

7.5 VENTILATE WITH NIV NAVA

NIV NAVA refers to ventilation using:

- nasal mask
- nasal prongs
- face mask
- total face mask
- single tube above the vocal cords
- NIV helmet

7.5.1 SET UP AND START VENTILATION

Important: Before switching to NAVA / NIV NAVA ventilation, all settings including backup settings must be set to achieve adequate ventilation.

1. Open the *Select Ventilation Mode* window.
2. Choose NIV NAVA (1).

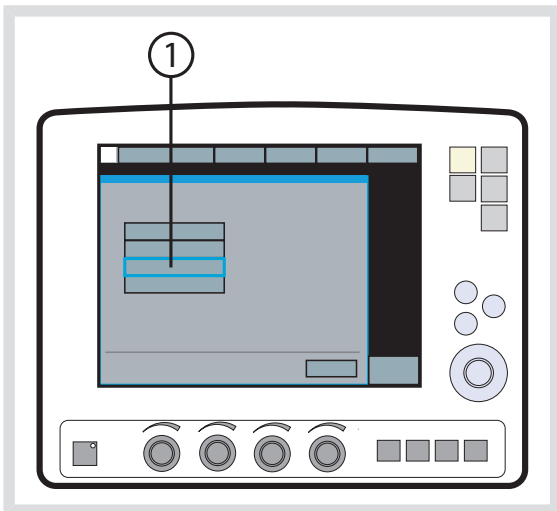

3. The Set Ventilation Mode parameters window opens.

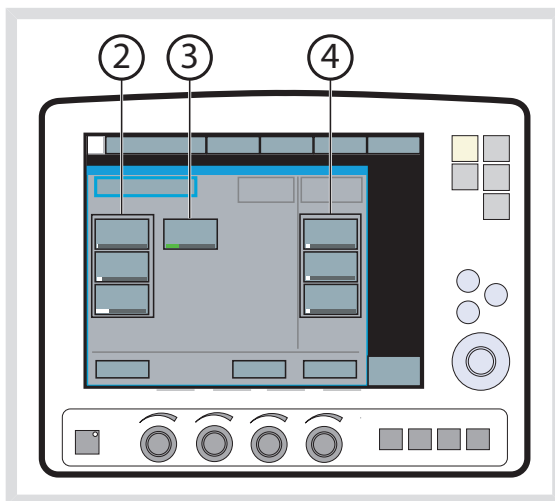

- **Basic settings (2):**

NAVA level, PEEP and O₂ conc. The initial NAVA level has been set. Use adequate values for PEEP and O₂ conc.

- **Trigg. Edi (3):**

The Trigg. Edi can be set between 0.1 and 2.0 μ V. Default is 0.5 μ V and rarely needs to be changed. The Edi trigger level may be varied to avoid noise in the Edi signal. The trigger is shown with a symbol and a color mark on the waveform.

- **Backup ventilation (4):**

Select the Pressure, Resp. Rate and I:E / Ti backup levels to achieve adequate ventilation in case of apnea.

See Backup Ventilation on page 127 .

7.6 NEURO VENTILATORY TOOL

The Neuro Ventilatory Tool (NVT) can be used to study the change in breathing pattern and breathing related parameters during a change in the assist (NAVA level) in NAVA and NIV NAVA.

The NVT window is reached from the Neuroventilatory Tool button of the Neural Access menu.

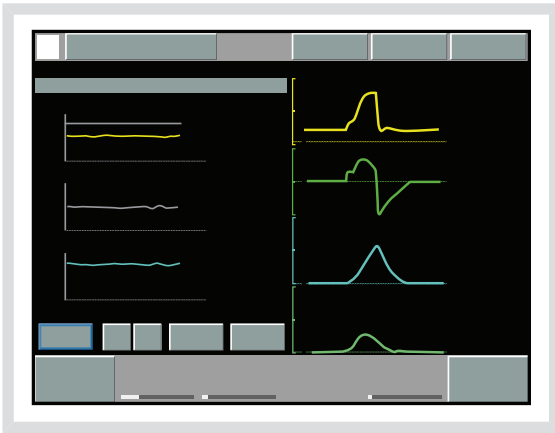

Curves in the NTV window will be presented as follows:

- First graph: Peak pressure and NAVA level as curves with relating values, PEEP as numerical value.
- Second graph: Edi peak and min. as curves with relating values. RR as numerical value only.
- Third graph: VTe and etCO₂ as curves with relating values, P0.1 and SBI as numerical values only.

The scales can be set by accessing NVT scales from the Neural Access menu.

To select which NAVA level to use in NAVA , increase the NAVA level from a low to a high assist and look for an inflection point (plateau) in the window. An assumption is that the NAVA level at the inflection point gives the optimal assist level in NAVA.

The functionality and interface of the Neuro Ventilatory Tool window is similar to the Open Lung Tool window; i.e. data is presented and stored breath by breath, and can be exported to a PC card.

8 ALARMS

TABLE OF CONTENTS

8.1	Introduction	172
8.2	Handling Alarms	174
8.3	Permanently silencing and turning of alarms	177
8.4	Alarm Settings for Breathing Parameters	180

8.1 INTRODUCTION

The SERVO-i Ventilator System is equipped with an alarm system to help ensure patient safety. Visual and audible alarms warn about:

- patient breathing problems e.g., apnea
- power problems e.g., loss of AC power
- problems with gases e.g., low supply pressure
- hardware problems e.g., overheating
- software problems e.g., memory failure

This chapter describes general responses to alarms, provides the procedure for setting alarm limits (see also the *Operation Overview* chapter), and lists breathing-related alarm settings along with their allowed ranges.

The *Power Supply* chapter describes power supply-related alarms.

The *System Messages* chapter lists all alarms along with possible causes and remedies.

WARNINGS!

- The default setting of the high airway pressure alarm is 40 cmH₂O. It is important to adjust this setting as appropriate to avoid excessive airway pressures.
- A potential hazard can arise if different default alarm settings are used on ventilators or similar equipment which are located within the same intensive care unit or cardiac operating theatres.

Important: Those responding to alarms must be health care professionals who have experience in ventilation treatment and who have been trained in the use of the SERVO-i Ventilator System.

8.1.1 ALARM OUTPUT CONNECTION OPTION

If your system is equipped with the alarm output connection option, high and medium priority alarms can be transferred to an external signal system. The alarm output signal is active as long as the audio alarm is active on the ventilator.

WARNING!

Never leave the patient unattended; the external alarm is designed to alert those already in attendance.

CAUTION:

The alarm output is a nonguaranteed alarm according to IEC 60601-1-8 and it is recommended that users establish a Pre-use check routine for this application.

8.1.2 VISUAL ALARM DISPLAY

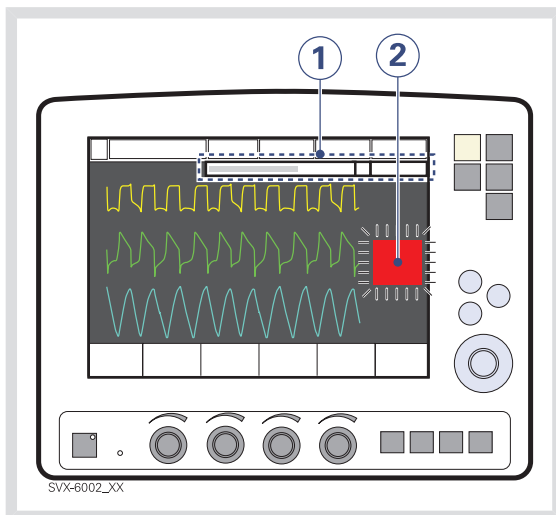

When an alarm is activated, the following information is supplied on the screen.

1. A text message explaining the cause of the alarm flashes in the alarm message area. The alarm with highest priority is displayed first.
2. The corresponding measured value or set value box flashes and an arrow points at the exceeded limit.

Note: Two bells in the alarm message area indicate that more than one alarm is activated.

8.2 HANDLING ALARMS

The system can signal four types of alarm:

- High Priority—red background
- Medium Priority—yellow background
- Low Priority—yellow background
- Technical—a numeric code

The following sections provide general information about viewing, responding to, silencing, and turning off alarms.

8.2.1 VIEWING THE CURRENT ALARMS WINDOW

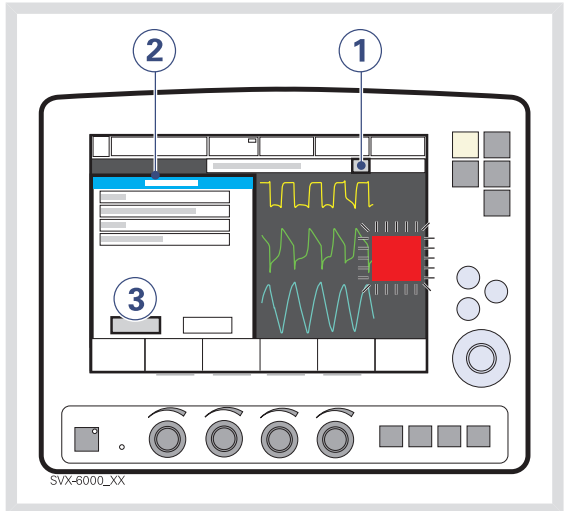

If more than one alarm is active, view the Current Alarms Window by:

1. Press the bell(s) in the alarm message touchpad.

All alarms (up to 10 listed by priority) are shown in a dynamic window that will be updated if more alarms occur while the window is open.
2. View the current alarms.
3. Press the History touchpad.

The previous 16 alarm-dependent events are listed chronologically, with the most recent event at the bottom.

Note: For viewing more than the latest 10 alarms, use the Event log to view all logged alarms.

8.2.2 RESPONDING TO ALARMS

To respond to a High or Medium priority alarm:

1. If desired, press the *Audio Pause* fixed key for less than two seconds to silence the alarm for two minutes.
2. Take action to resolve the alarm condition.
3. Press the *Audio Pause* key to reset the latched high priority alarm and clear the message from the screen.

The *Audio Pause* key is identified by the  symbol.

To respond to a Low priority alarm:

1. If desired, press the *Audio Pause* key for less than two seconds to reset the alarm even if the alarm condition remains.
2. Take action to resolve the alarm condition.

The alarm is automatically reset once the alarm condition ceases.

Note:

The following alarms display an *Audio off?* message when activated:

- *Air/HeO₂ Supply Pressure: Low*
- *O₂ Supply Pressure: Low*
- *Battery Operation*

For these alarms, you can silence the audio signal even if the alarm condition is not resolved. However, the system will eventually reactivate the alarm.

Using the Audio Pause Key

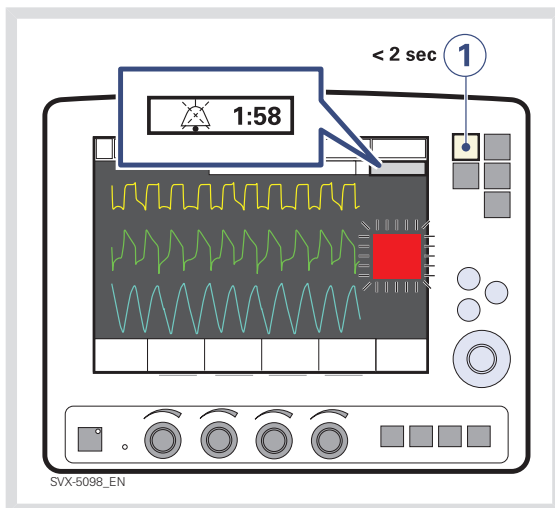

Pressing the *Audio Pause* fixed key for less than two seconds has the following results:

- Active alarms are silenced for two minutes.
- A crossed bell symbol along with the time remaining in the silent period are displayed in the message area.
- Each press of the *Audio Pause* key restarts the two minute silent period from when the user last pressed the key.
- Latched alarms are reset if the alarm condition has ceased.

Note: The *No battery capacity* alarm and technical alarms cannot be silenced.

8.2.3 PRE-SILENCING ALARMS

To silence most alarms (active and inactive) for two minutes, press and hold the *Audio Pause* fixed key for more than two seconds. This action has the following results:

- All alarms, active and inactive, are silenced for two minutes from the time the key was pressed.
- A double crossed bell symbol along with the time remaining in the silent period are displayed in the message area.
- Pressing the *Audio Pause* key again for less than two seconds will now restart the silent period for two additional minutes from when the user last pressed the key.
- Latched alarms are reset if the alarm condition has ceased.

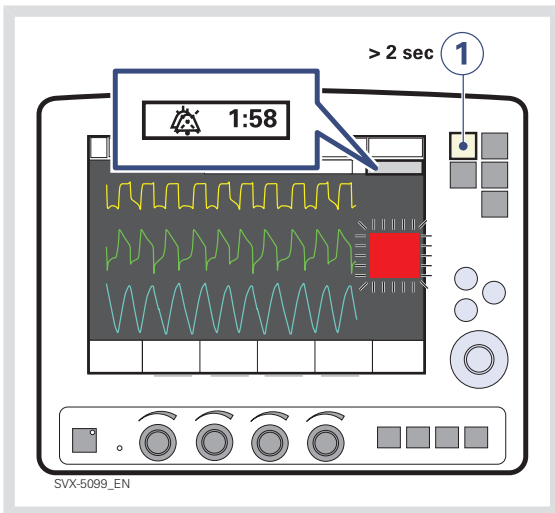

When the alarms are pre-silenced, pressing and holding the *Audio Pause* key again for more than 2 seconds will reactivate all audible alarms.

8.2.4 RESPONDING TO TECHNICAL ALARMS

In some cases, restarting the system may resolve a technical alarm. However, technical alarms often necessitate taking the ventilator out of operation and having it serviced. See the chapter System Messages, section Technical error messages on page 212 for further details.

8.2.5 RESETTING LATCHED ALARMS

High Priority alarms are “latched” — the alarm message remains on the screen even if the alarm condition ceases. Medium and Low Priority alarms are not latched. The fixed key *Audio Pause* resets latched alarms and clears the alarm message from the screen.

Note: The NIV alarm *Leakage out of range* is not latched.

8.3 PERMANENTLY SILENCING AND TURNING OF ALARMS

8.3.1 NON INVASIVE VENTILATION

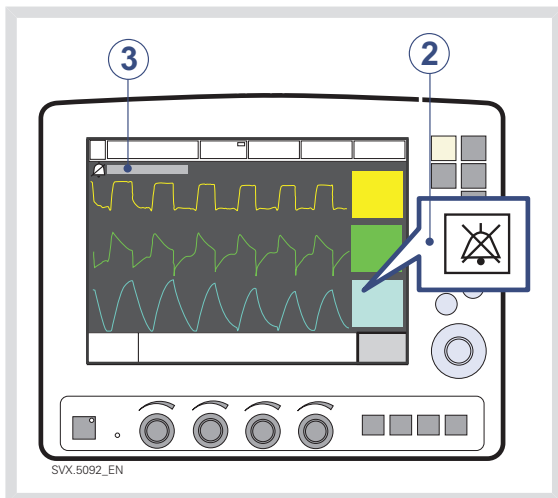

To permanently silence certain alarms in NIV mode:

1. Press the *Alarm Profile* fixed key.
2. Press the touchpad corresponding to one of the following alarms:
 - Minute Volume
 - Respiratory Rate
 - End Exp. pressure
 - End tidal CO₂ (CO₂ Analyzer - option)
 - CPAP (Nasal CPAP - option)
3. Press the *bell-symbol* touchpad.
The symbol changes to a crossed bell indicating audio is off.

Note: If the system is set in Standby and used in an invasive mode, the NIV alarms will return to their default states.

8.3.2 LOW MINUTE VOLUME ALARM - AUDIO OFF

For Infant invasive ventilation only, the Low Minute Volume alarm may be permanently silenced (*Audio off*) when the Upper minute volume alarm is set to 1 l/min or less.

The function of muting the Low Minute Volume alarm is enabled or disabled via *Menu>Biomed>Edit configuration>Infant alarm limits* window. The setting is called *Low MV audio off* and is disabled as the default. When enabled the *audio off* (bell symbol) is displayed next to the *Minute Volume Alarm* in the *Alarm profile* window.

WARNING! Always use additional patient monitoring (e.g. SpO₂, CO₂) when the low expiratory minute volume alarm is set to audio off.

8.3.3 RESPONDING TO TECHNICAL ALARMS

In some cases, restarting the system may resolve a technical alarm. However, technical alarms often necessitate taking the ventilator out of operation and having it serviced. See the chapter System Messages, section Technical error messages on page 212 for further details.

8.3.4 TURNING OFF THE APNEA ALARM IN NASAL CPAP

To turn off the apnea alarm in Nasal CPAP mode:

1. Press the *Alarm Profile* fixed key.
2. Press the touchpad corresponding to the apnea alarm.
3. Turn the Main Rotary Dial until the time limit has reached its maximum.
4. Continue turning the Main Rotary Dial.

A message is displayed indicating the apnea alarm is turned off.

8.3.5 TURNING OFF THE LEAKAGE FRACTION TOO HIGH ALARM

The *Leakage fraction too high* alarm is an alarm in Infant configuration for NIV NAVA.

The alarm can be configured via the *Menu>Biomed>Edit configuration>NIV infant alarms* window.

To turn off the Leakage fraction too high alarm in NIV NAVA mode:

- Press the *Alarm Profile* fixed key.
- Press the symbol touchpad indicating the *Leakage fraction too high* alarm. When the symbol is crossed out, the alarm is turned off.

If the leakage fraction is disabled in the *Alarm Profile* window the message *Alarm (s) off* is displayed.

8.3.6 TURNING OFF NAVA APNEA ALARMS

The apnea alarms *No patient effort* and *No consistent patient effort* can be turned off in NAVA and NIV NAVA.

This is only available in the infant patient category.

If the *No patient effort* alarm is turned off, the ventilator will switch to backup ventilation when the time between breaths exceeds the apnea time setting. This switch to backup ventilation is always active irrespective of any changes in the alarm configuration. This is available in both NAVA and NIV NAVA.

If the *No consistent patient effort* alarm is turned off, the system will not lock in backup ventilation. This is only available in NAVA.

To turn off the apnea alarms:

- Access the alarm configuration window.
 - NAVA infant:
Menu>Biomed>Edit configuration>Infant alarm limits
 - NIV NAVA infant:
Menu>Biomed>Edit configuration>NIV Infant alarms
- Press the corresponding touchpad to have it switch from *Disabled* (default setting) to *Enabled*.
- Press *Accept*.

Enabling *NAVA Apnea off* in the alarm configuration generates a touchpad in the alarm profile window.

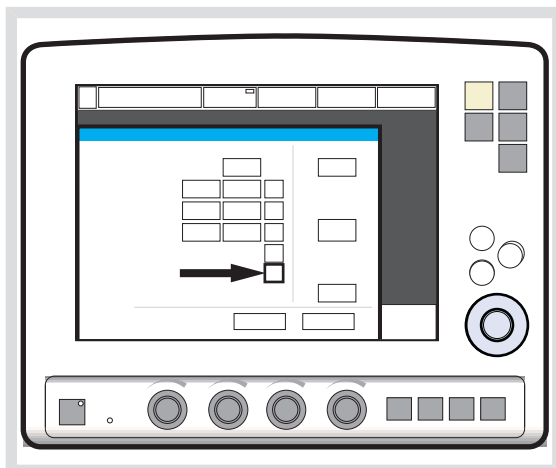

NAVA apnea alarms can be toggled on and off by pressing the *Alarm on* or *Alarm off* symbol. Turning off these alarms will cancel the possibility to set *Apnea audio delay*.

A notification, *Alarm(s) off*, is shown in the message area when these alarms are disabled.

Once set, the NAVA apnea alarms configuration settings remain valid until the system has been turned off. Restarting the system restores default alarm configuration settings.

8.4 ALARM SETTINGS FOR BREATHING PARAMETERS

This section discusses viewing and setting alarm limits, lists alarm settings, explains the conditions under which alarm limits are set to their default values.

See section Alarm limits on page 231.

8.4.1 VIEWING ALARM LIMITS

Alarm limits may be viewed in the Measured Values Display on the right side of the screen. See the *Monitoring and Recording* chapter for details on the Measured Value Display.

8.4.2 SETTING ALARM LIMITS

To set alarm limits, touch the fixed key Alarm Profile in the upper right corner of the screen (see the *Operation Overview* chapter for details about setting limits).

8.4.3 CONDITIONS LEADING TO DEFAULT ALARM SETTINGS

Alarm limits become set to their default values when:

- restarting the ventilator
- admitting a new patient
- changing type of ventilation (option)
- changing patient category (option)
- the ventilator has been totally without power for more than 2 minutes.

8.4.4 LIST OF ALARM SETTINGS

Automatically Set—These settings are determined automatically by the ventilator based on the related parameter settings:

- *O₂ concentration high* (based on O₂ concentration setting)
- *O₂ concentration low* (based on O₂ concentration setting)
- *High continuous pressure* (based on PEEP setting)

Upper Limit - These settings define an upper limit based on a condition that is monitored by the ventilator.

- *Paw high* (airway pressure too high)
- *Apnea* (maximum time exceeded)

Breathing Parameter Alarms—These settings define an allowed range for a breathing parameter:

- *Expired minute volume* (high and low)
- *Respiratory rate* (high and low)
- *End Exp. Pressure* (high and low)
- *End Tidal CO₂* (high and low)
- *CPAP* (high and low)

9 OPTIONAL ACCESSORIES

TABLE OF CONTENTS

9.1	General	182
9.2	Active humidifiers	182
9.3	Nebulizers	183
9.4	Servo Ultra Nebulizer	186
9.5	Aeroneb Micropump Nebulizer	189
9.6	CO ₂ analyzer	193
9.7	Y Sensor	197
9.8	NIV Helmet	199
9.9	Compressor Mini	200

9.1 GENERAL

Applied parts, i.e. equipment making physical contact with the patient, comprise nebulizer patient unit and cable, Y Sensor, CO₂ sensor, Edi Catheter and cable and the Ventilator Breathing System described in System Flow Chart, Ventilation, Patient Connection, part no. 66 92 522.

9.2 ACTIVE HUMIDIFIERS

The use of an active humidifier is often beneficial for patients undergoing ventilatory treatment.

The following humidifiers can be used with the SERVO-i Ventilator System:

- Fisher & Paykel Humidifier MR850
- Teleflex Medical ConchaTherm Neptune Heated humidifier

Please refer to the manufacturer's operating manual for instructions on use.

WARNINGS!

- Use only the MAQUET approved active humidifier F&P MR850 with HeO₂. Use of non-approved active humidifiers may result in higher gas temperatures and increase resistance in filters.
- During humidification, carefully monitor the airway pressure. Increased airway pressure could result from a clogged filter. Replace the filter if the expiratory resistance increases or after maximum usage time according to filter specification, whichever comes first.

Important:

- Use only tubes recommended by MAQUET. Soft tubing may negatively affect the performance of the ventilator.
- If a single heated breathing circuit is used in the system a water trap must be used on the expiratory tube to avoid condensation in the system. During operation the water traps must be checked regularly and if necessary emptied.
- Fisher & Paykel's Evaqua circuit can be used as a dual heated breathing circuit with the SERVO-i Ventilator System.
- Accessories connected to the tubing system may cause changes in patient pressure.
- An extended leakage test during Pre-use-check must be performed when using the Teleflex Medical ConchaTherm Neptune Heated humidifier. This can be enabled in the *Edit start-up configuration* window.

9.3 NEBULIZERS

9.3.1 GENERAL

The nebulizer is intended for administering drugs to patients requiring mechanical ventilation or positive pressure breathing assistance via an endotracheal tube or face mask/prongs.

The nebulizer operates continuously regardless of ventilation mode setting. No extra gas volume is added to the inspiratory minute volume and ventilator settings and values are not affected

The SERVO-i Ventilator System must not be used with jet nebulizers.

Please refer to the manufacturer's operating manual for instructions on use.

9.3.2 NEBULIZER USE GUIDELINES

These guidelines are reminders for healthcare professionals who have already been trained to use nebulizers.

WARNINGS!

- Before administering any medication via the nebulizer, consult the manufacturer regarding the appropriateness of nebulization for that medication. Only use physician prescribed solutions.
- During nebulization, there may be a higher deposition of drug used when HeO₂ is used instead of air.
- During nebulization, carefully monitor the airway pressure. Increased airway pressure could result from a clogged filter. Replace the filter if the expiratory resistance increases or after maximum usage time according to filter specification, whichever comes first.
- During nebulization, check frequently that aerosol is being generated.
- Disconnect the Servo Humidifier/HME during nebulization; otherwise the humidifier may become blocked or the drug may be trapped in the humidifier
- To avoid explosion hazards, do not use flammable agents such as ether and cyclopropane or aerosolize alcohol based medications which can ignite in oxygen enriched air under high pressure with this device.
- Do not use the nebulizer without a filter e.g. Servo Duo Guard, connected to the expiratory inlet of the ventilator.

- Condensate can collect and occlude ventilator circuits. Always position ventilator circuits so that fluid condensate drains away from the patient.

CAUTION:

The nebulizer must not be left unattended when connected to a patient.

If a nebulizer and the CO₂ Analyzer are in use simultaneously, the CO₂ reading may be affected.

Important:

When using a nebulizer, the accuracy of the Y Sensor measurement may be compromised. Remove the Y Sensor from the patient circuit when a nebulizer is in use.

9.3.3 NEBULIZER FUNCTION TEST

Perform a function test prior to first use or at any time to verify proper operation.

1. Visually inspect each part of the system for cracks or damage and replace if any defects are visible.
2. Pour 1-6 ml of sterile water or normal saline (0.9%) into the nebulizer unit.
3. Connect the control cable to the SERVO-i Ventilator System.
4. Start nebulization.
5. Check that the aerosol is visible.
6. Discard any remaining liquid before patient use.

Always perform a leakage test of the breathing circuit after inserting or removing the nebulizer unit.

NEBULIZATION ON/OFF

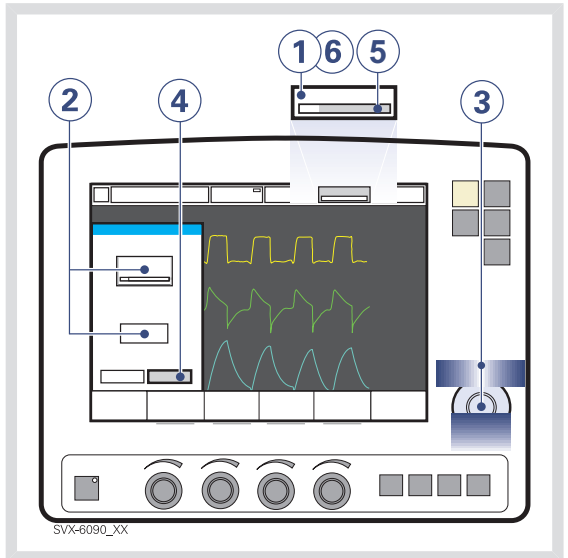

To operate the nebulizer:

1. Press the *Nebulizer* touchpad.
2. Press the *Time* touchpad or the *Continuous* touchpad for desired nebulization.

If *Continuous nebulization* is selected, the *Time* touchpad is not visible, press the *Continuous* touchpad and the *Time* touchpad will reappear.

3. Set the time using the Main Rotary Dial.
4. Press *Accept* to accept time and start nebulization.
5. View the remaining nebulization time.
6. Press the *Nebulizer* touchpad to change the time or cancel nebulization.

9.4 SERVO ULTRA NEBULIZER

The Servo Ultra Nebulizer has been discontinued.

The information in this document applies to devices sold with versions 6.1 and earlier of the SERVO-i Ventilator System.

WARNINGS!

- For adult/pediatric patients, never fill the medication cup with more than 10 ml.
- For neonatal patients, never fill the medication cup with more than 4 ml.
- If the patient unit of the nebulizer is tilted nebulizer function may be affected, the drug can flow into the patient's lungs or the ventilator.
- Do not use the nebulizer without buffer liquid (sterile water); otherwise the ultrasonic generator crystal may break.
- Before starting the nebulizer check that the medication cup is undamaged and firmly in place.
- During nebulization, check the buffer liquid level. The level must be between MIN and MAX when the nebulizer is operating.

CAUTION: The active humidifier must be switched off when using the Servo Ultra Nebulizer, otherwise the particle size may be affected.

Notes:

- The Servo Ultra Nebulizer may be interrupted briefly due to overheating. It will automatically start again when the buffer water has cooled. During this short period of time no alarm is activated and the timer is not interrupted.
- The Servo Ultra Nebulizer is disabled whenever the ventilator is running on battery power.

9.4.1 NEBULIZER COMPONENTS

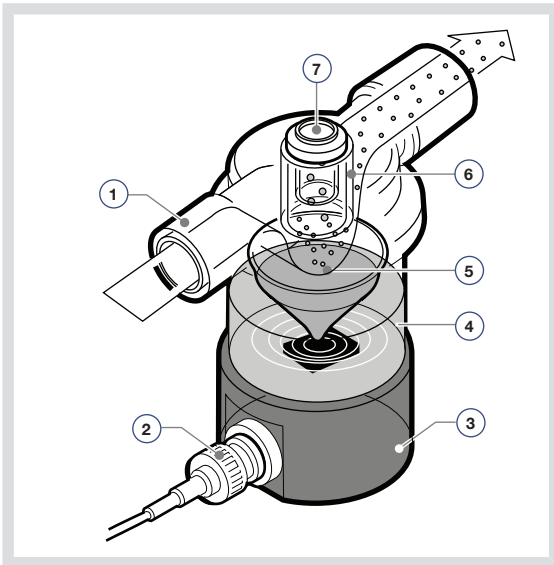

1. Gas from ventilator
2. Control cable
3. Ultrasonic generator
4. Sterile buffer water
5. Medication aerosol produced in the medication cup.
The 10 ml cup is disposable. It can be filled during nebulization through the injection membrane in the T-piece, or before mounting the T-piece. The medication mist is carried to the patient by the inspiratory flow.
6. T-piece with mechanical particle separation system (baffles).
The system ensures a mass median diameter (MMD) of approximately $4.0\ \mu\text{m}$ for droplets in the mist delivered to the patient. Larger droplets are renebulized.
7. Injection membrane

CONNECTION TO BREATHING CIRCUITS

Connect the nebulizer between the inspiratory tube and the Y-piece. Connect the control cable to the SERVO-i Ventilator system.

Connecting to 22 mm breathing circuits

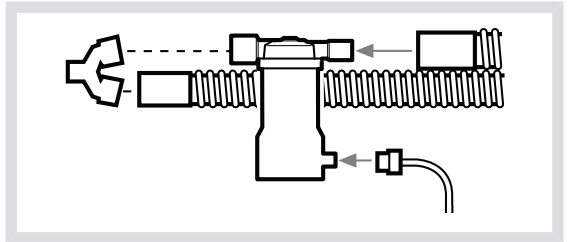

Connecting to 15 mm breathing circuits

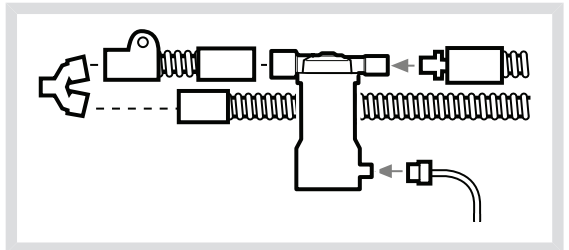

Connecting to 10 mm breathing circuits

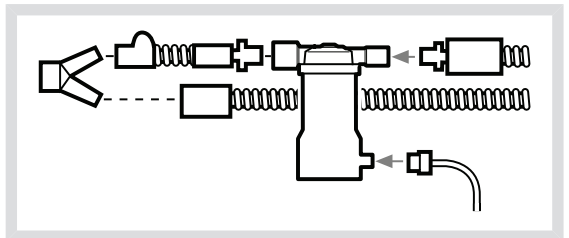

ADDING MEDICATION

1. Make sure the nebulizer is turned off.
2. Pour sterile water to the MAX. level indication.

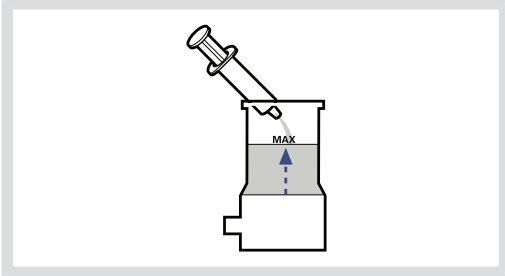

3. Attach a new medication cup.

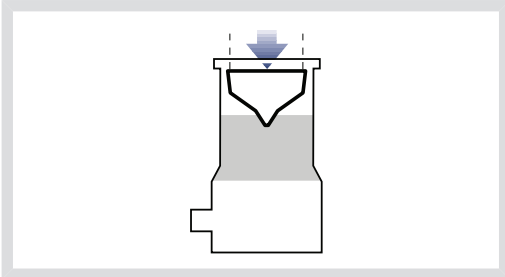

4. Fill the medication cup with medication (max. 10 ml for adults, max. 4 ml for Infants).

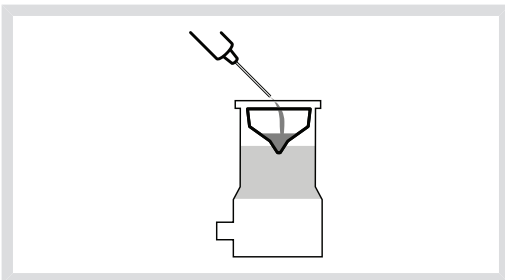

5. Fit the T-piece firmly to its end position. Check that the injection membrane is in place and not damaged.

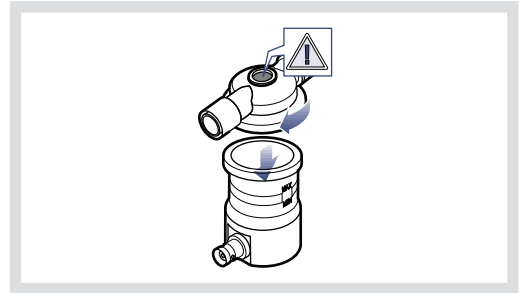

Important: Invisible damage will be detected during the Pre-use check. A faulty injection membrane may cause system leakage.

9.5 AERONEB MICROPUMP NEBULIZER

WARNINGS!

- Do not apply undue pressure or push out the domed aperture plate in the center of the nebulizer.
- Do not use a syringe with a needle to add medication.
- Do not use the Aeronex Pro Nebulizer unit in the continuous mode.

CAUTIONS:

- Perform a functional test prior to use to ensure correct operation, see section Nebulizer function test on page 185.
- If the Aeronex nebulizer is used with active humidification, then the particle size of the medication may be affected.

ASSEMBLE THE NEBULIZER UNIT

1. Perform a functional test prior to use to verify proper operation. See section Nebulizer function test on page 185.
2. Connect the nebulizer unit to the T-piece by pushing the nebulizer unit firmly onto the T-piece.

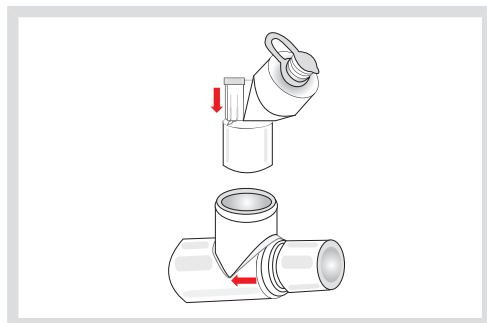

3. Insert the nebulizer and the T-piece into the breathing circuit with the arrow on the T-piece pointing in the direction of the air flow within the circuit.
4. Connect the control cable to the SERVO-i Ventilator System.

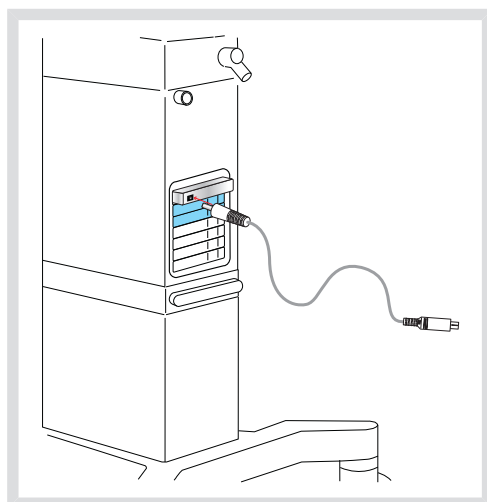

CONNECTION TO BREATHING CIRCUITS

Connect the nebulizer between the inspiratory tube and the Y-piece. Connect the control cable to the SERVO-i Ventilator system.

Connecting to 22 mm breathing circuits

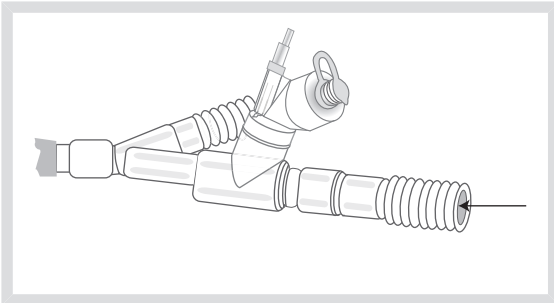

Connecting to 15 mm breathing circuits

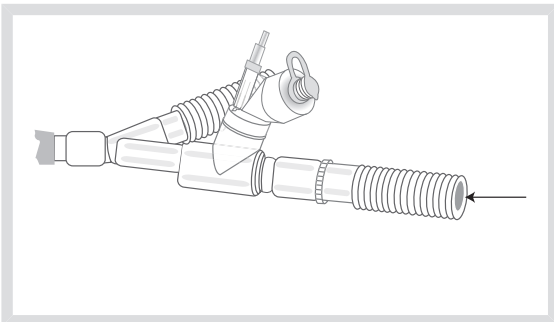

Connecting to 10 mm breathing circuits

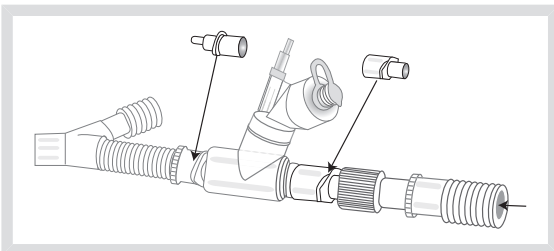

Connecting to 12 mm neonatal breathing circuits using neonate T-piece

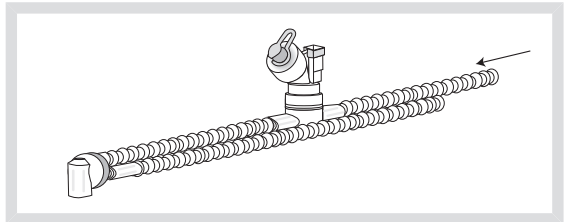

ADDING MEDICATION

1. Open the filler cap plug on the nebulizer unit.
2. Use a pre-filled ampoule or syringe to add medication into the filler port of the nebulizer unit.
3. Close the filler cap plug.

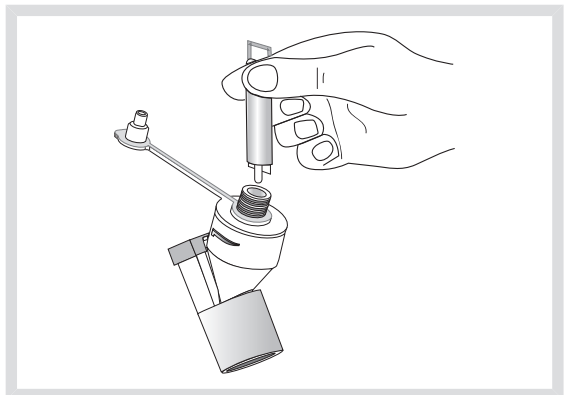

Note: Medication can also be added in this manner during nebulization. This does not interrupt nebulization or ventilation.

9.5.1 PRO NEBULIZER UNIT

The Pro nebulizer unit has a defined lifetime of a minimum of one year based on a typical usage profile of 4 treatments per day and one sterilization per week where the device is assumed to be in service for 50% of the time. If this service pattern is exceeded, it may reduce the life of the product.

Important: The nebulizer unit holds up to 10 ml of liquid medication.

When the nebulizer unit is connected into the ventilator circuit, the silicone plug can be opened and closed in between doses without causing loss of circuit pressure.

WARNINGS!

- Always maintain the nebulizer in a vertical position (with the filler cap uppermost) while in the patient circuit. This position prevents condensate from blocking the nebulizer and ensures proper nebulization.
- Do not attach a continuous supply of medication to the nebulizer; the device operates in 5 to 30 minute cycles.
- When removing the nebulizer unit from the patient circuit, always replace the T-piece plug to maintain circuit pressure.

Note: The nebulization rate is >0.2 ml/min, fill the medication cup and set the nebulization time accordingly.

9.5.2 SOLO NEBULIZER UNIT

The Solo nebulizer unit has a defined validated lifetime of:

- Intermittent use a maximum of 28 days based on a typical usage profile of 4 treatments per day.
- Continuous use a maximum of 7 days.

Do not exceed the recommended usage time.

Important: The nebulizer unit holds up to 6 ml of liquid medication.

When the nebulizer unit is connected into the breathing circuit, the filler cap can be opened or removed from the nebulizer unit without causing loss of circuit pressure.

WARNINGS!

- This is a single patient use device not to be used on more than one patient to prevent cross-infection.
- The nebulizer unit and T-piece, as packaged, are not sterile.
- Never use reusable connectors with disposable nebulizer units and vice versa.

Important: For intermittent nebulization, the doses must be ≤ 6 ml.

CONTINUOUS NEBULIZATION

See Aerogen Continuous Nebulization Tube assembly instructions.

WARNING! To ensure correct and safe connection between the nebulizer and the medication reservoir, follow the medication tube from the nebulizer back to the medication reservoir to make sure that the medication tube is connected to the correct source.

CAUTION: Check regularly the level of medication in the nebulizer unit during continuous nebulization.

The input rate of medication into the nebulizer unit during continuous nebulization must not exceed 0.2 ml per minute or 12 ml per hour. Dose volumes and concentrations must be determined accordingly.

To operate the nebulizer in *Continuous nebulization*:

1. Press the *Nebulizer* touchpad.
2. Press the *Continuous* touchpad.
A dialog *Make sure an Aeroneb Solo nebulizer unit is connected before activating Continuous nebulization.* is displayed on the screen.

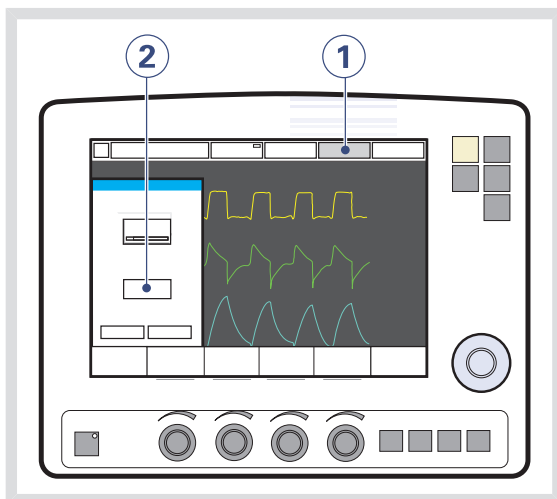

3. Press *OK* to confirm.
Continuous nebulization is selected.

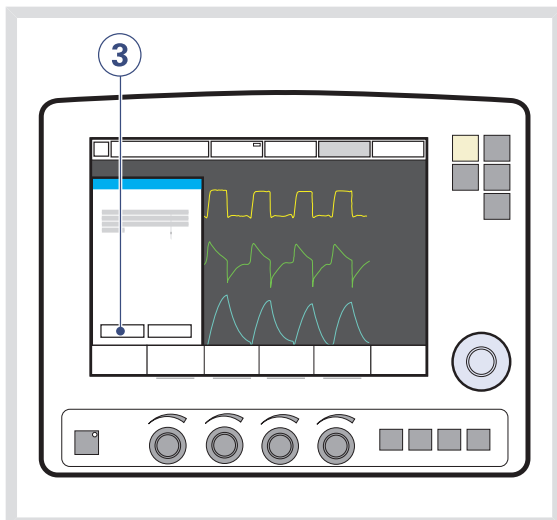

4. Press *Accept* to start nebulization. *Continuous nebulization* is indicated on the active *Nebulizer* touchpad.

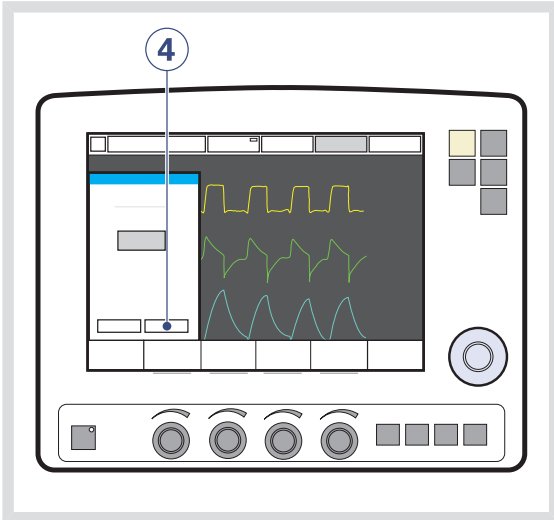

5. Press the *Nebulizer* touchpad to cancel nebulization. A dialog *Do you really want to turn off nebulization?* is displayed on the screen. Press *OK* to confirm.

9.6 CO₂ ANALYZER

When the CO₂ Analyzer is in use, the following data is displayed on the screen:

- CO₂ concentration vs. time (waveform)
- End Tidal CO₂ concentration (etCO₂)
- CO₂ minute elimination
- CO₂ tidal elimination

Alarm limits for high and low etCO₂ can be individually set.

The airway adapter can be either disposable or reusable.

CAUTIONS:

- The disposable airway adapter is intended for single patient use only, do not re-use, clean or sterilize.
- If a nebulizer and CO₂ Analyzer are in use simultaneously, the CO₂ reading may be affected.

Important: If the upper alarm limit is set above the maximum measuring range, no alarm will be activated even if the upper limit is exceeded.

9.6.1 CO₂ ANALYZER USE GUIDELINES

These guidelines are reminders for health care professionals who have already been trained to use the CO₂ Analyzer:

- The capnostat sensor and airway adapter windows should be placed vertically to reduce the possibility of optical interference due to window contamination. Connect the airway adapter between the Y-piece/Servo Humidifier and the endotracheal tube/face mask/prongs.
- Do not insert two CO₂ modules at the same time. The SERVO-i Ventilator System can only handle one CO₂ module at a time.
- Use only a MAQUET airway adapter with the capnostat sensor.
- If the message *Check CO₂ airway adapter* appears, then make sure that the adapter is completely inserted. Wipe the airway adapter if necessary.

9.6.2 CO₂ ANALYZER COMPONENTS

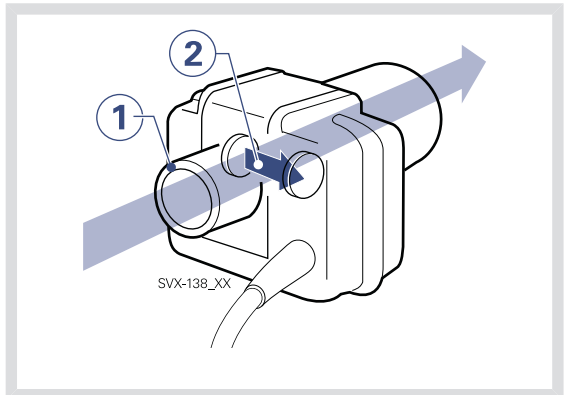

1. Gas flow through the airway adapter in the capnostat sensor.
2. The sensor uses a solid state and IR based optical system with no moveable parts. It measures the difference between a reference light beam and one filtered for CO₂ wave lengths.

9.6.3 CO₂ ANALYZER CALIBRATION

Before beginning the calibration procedure make sure the capnostat sensor is warm. Values displayed during warm-up have reduced accuracy. If calibration is needed, a message will appear.

CAPNOSTAT 5

To calibrate the CO₂ analyzer:

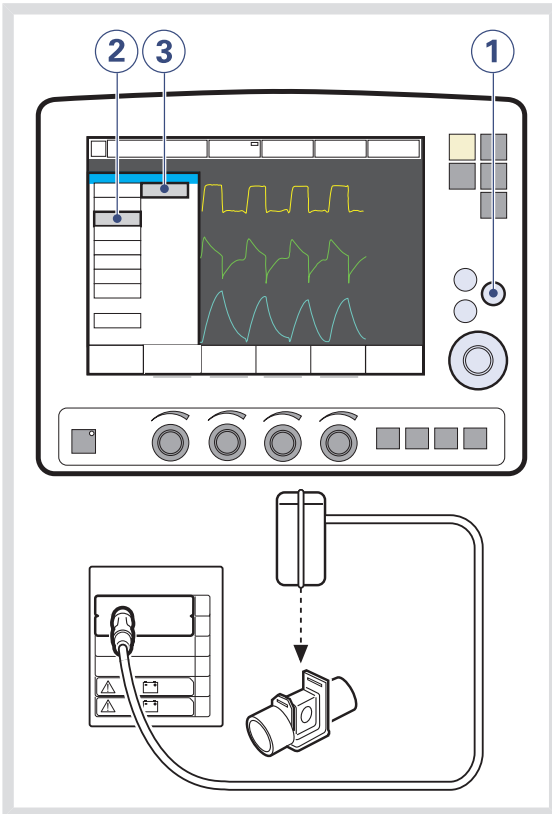

1. Press the *Menu* fixed key.
2. Press the *Options* touchpad.
3. Press the *CO₂ calibration* touchpad.
4. Press the *Verification* touchpad.
5. Place the sensor on an unconnected airway adapter, containing room air. Press the *OK* touchpad.

CAPNOSTAT 3

The Capnostat 3 CO₂ analyzer has been discontinued. The information in this document applies to devices sold with versions 7.0 and earlier of the SERVO-i Ventilator System.

There are two calibration options: cell zero and verification (see later in this section).

To calibrate the CO₂ Analyzer:

1. Press the *Menu* fixed key.
2. Press the *Options* touchpad.
3. Press the *CO₂ calibration* touchpad.
4. Press the *Cell zero* touchpad if the capnostat sensor has been shifted.
5. Press the *Verification* touchpad to perform a calibration including cell zeroing, verification against reference cell, and adapter zeroing.

Important: Verification calibration is recommended. Always perform a verification when the airway adapter is altered, a faulty Capnostat sensor is suspected, or the system requests calibration. Perform a cell zero calibration if the Capnostat sensor has been shifted.

Press the *Cell zero* touchpad if the capnostat sensor has been shifted.

Procedure Diagram: CO₂ Analyzer Calibration

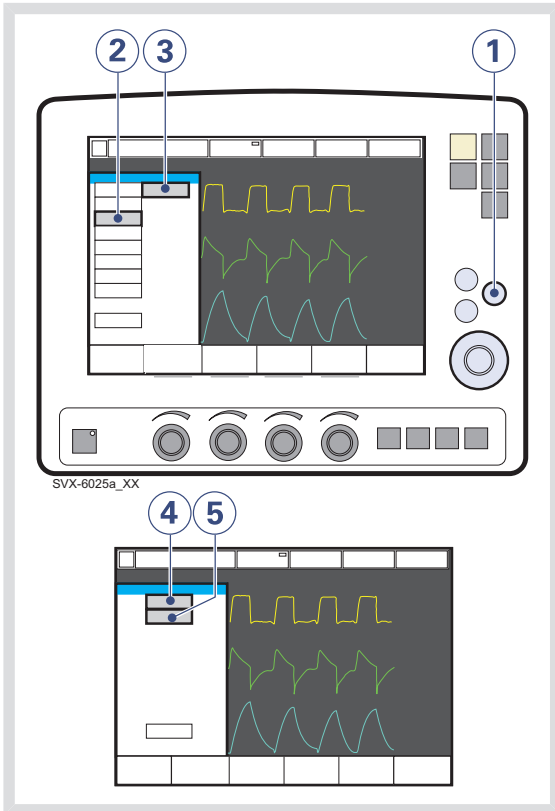

Cell Zero Calibration

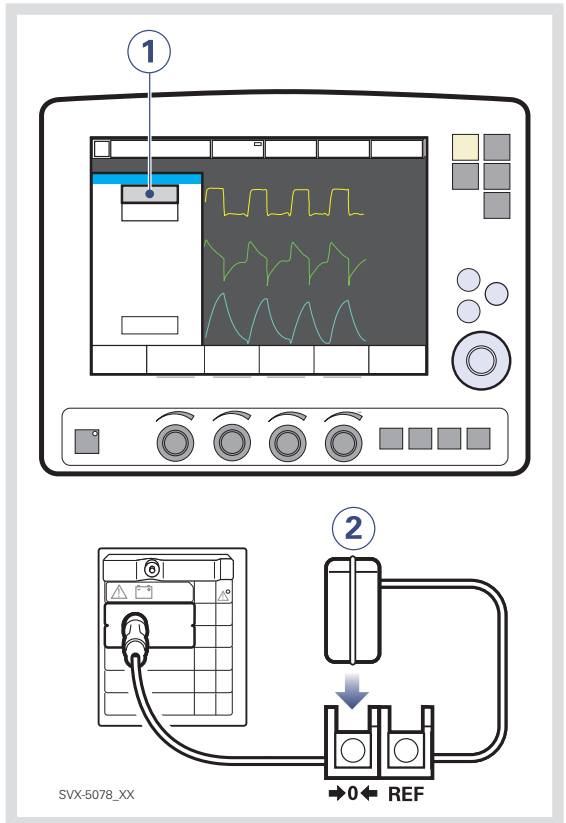

- The *etCO₂ concentration low* alarm can be permanently silenced (Audio off) when the message *Silence alarm permanently?* is shown.
- During calibration no CO₂ waveforms or measured CO₂ values will be displayed.
- During zero calibration the adapter must contain room air only.

1. Press the *Cell zero* touchpad; wait for on-screen instructions.
2. Place the capnostat sensor on the zero cell.

Verification Calibration

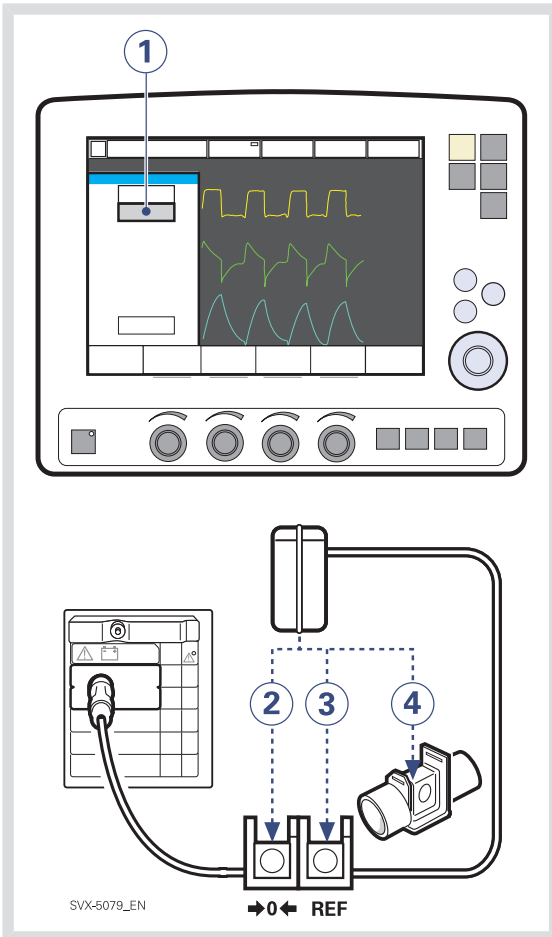

1. Press the *Verification* touchpad; wait for on-screen instructions.
2. Place the capnostat sensor on the zero cell; wait for on-screen instructions.
3. Place the capnostat sensor on the reference cell; wait for on-screen instructions.

4. Place the capnostat sensor on an unconnected airway adapter, containing room air.

9.7 Y SENSOR

The Y Sensor is a fixed-orifice, differential pressure sensor. It allows the pressure and flow to be measured close to the patient's airway. The Y Sensor can be used in all ventilation modes.

WARNING! The Y Sensor is incompatible with HeO₂ and will be disabled when HeO₂ is used.

Important: When using a nebulizer, the accuracy of the Y Sensor measurement may be compromised. Remove the Y Sensor from the patient circuit when a nebulizer is in use.

Notes:

- To guarantee that waveforms and measured values are always displayed on the screen, the internal pressure and flow sensors are at all times active as backup. Their readings are compared with the Y Sensor measurement. The Y Sensor is disabled if there is a significant deviation or malfunction.
- A Pre-use check or a Patient Circuit Test is required prior to using the Y Sensor.

9.7.1 Y SENSOR USE GUIDELINES

These guidelines are reminders for health care professionals who have already been trained to use the Y Sensor.

CAUTIONS:

- The Y Sensor is intended for single patient use only, do not re-use, clean or sterilize.
 - Frequently check for condensed water or other fluids in the Y Sensor. Fluids in the Y Sensor can cause immediate loss of accuracy or long-term drift.
-
- Connect the Y Sensor between the Y-piece and the endotracheal tube/mask.
 - Do not insert two Y Sensor modules at the same time. The SERVO-i Ventilator System can handle only one Y Sensor module at a time.
 - Do not apply tension to the Y Sensor tubing.
 - Make sure that the connectors to the SERVO-i Ventilator System are pointing upwards.
 - Make sure there are no kinks in the Y Sensor tubing.
 - If the Y Sensor is not connected to the module, do not connect to the patient circuit as this may cause leakage.

9.7.2 Y SENSOR COMPONENTS

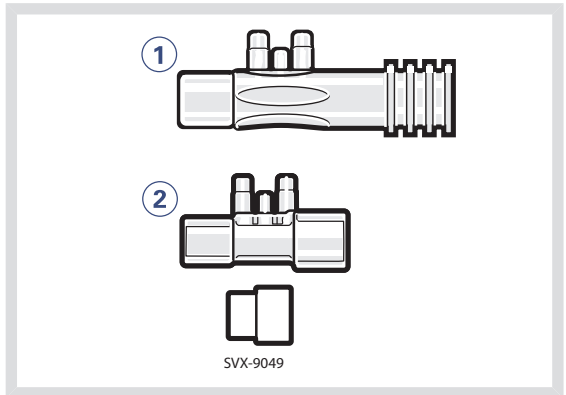

The two versions of the disposable, single-use Y Sensor — Adult (1) and Infant (2) — are shown in the figure above. The Infant sensor includes an adaptor for use with the neonate CO₂ adapter.

9.8 NIV HELMET

This section is intended to clarify the use of the non invasive helmet application with the SERVO-i Ventilator System. For user instructions for the helmet application refer to the helmet manufacturers instructions.

9.8.1 BEFORE USE

The use of SERVO-i Ventilator System Universal is recommended with the helmet application to ensure adequate flow can be delivered to all patients regardless of patient lung capacity in all relevant settings.

9.8.2 PATIENT RANGES

The helmet application can be used with SERVO-i Ventilator System for patients between 10 and 250 kg. Use only the Adult patient range on the SERVO-i Universal.

9.8.3 VENTILATION MODES

The helmet application must only be used with pressure supported ventilation (invasive, non invasive or NIV NAVA).

CAUTION: When using the NIV Pressure Support or NIV NAVA mode the user **must** initiate the filling of the helmet by pressing the *Resume ventilation* pad on the screen. This **must** also be done after disconnection.

Important: To secure a proper patient triggering function the PEEP level should never be set below 3 cmH₂O. When helmets with a safety valve are used, it is recommended to set a PEEP level of minimum 5 cmH₂O.

9.8.4 ALARMS

Important: Alarms related to volume are not reliable. To avoid nuisance alarms the corresponding alarm limits must be properly set.

9.8.5 SAFE USE OF HELMET APPLICATIONS WITH SERVO-i VENTILATOR SYSTEM

- Do **not** rely on flow and volume parameters.
- The volume in the helmet serves as a capacitance and may cause delays in patient triggering.
- Make sure that the helmet used eliminates CO₂ re-breathing .
- High pressure levels may effect the patient's ears and the flow may effect the patient's eyes.
- Patients can perceive the helmet application as noisy. A Servo Duo Guard filter used on the inspiratory side will reduce the noise level. The noise level can vary between different helmets.
- Do not use nebulizers.
- Do not use humidified ventilation gas as this will cause condensation on the helmet walls.
- Do not use the Y Sensor measuring option.
- Do not use the CO₂ option.

9.9 COMPRESSOR MINI

The Compressor Mini provides a continuous flow of pressurized air in the absence of a central gas supply or gas cylinders.

Using surrounding air, the compressor collects and stores gas for direct use with the SERVO-i Ventilator system as long as the ventilator is active.

Please refer to the Compressor Mini User's Manual.

10 SYSTEM MESSAGES

TABLE OF CONTENTS

10.1	Introduction	202
10.2	High priority alarms	203
10.3	Medium priority alarms	207
10.4	Low priority alarms	211
10.5	CO ₂ Analyser: Calibration error messages (Option)	211
10.6	Technical error messages	212

10.1 INTRODUCTION

This chapter lists and describes alarms and error messages both for CO₂ Analyzer calibration and technical problems. The lists also suggest actions in response to the messages.

WARNING! Always disconnect the patient from the ventilator when performing operations that increase risk to the patient, such as replacing the O₂ cell.

CAUTION: Do not lift or disconnect the expiratory cassette when the ventilator is operating; instead, you may do this in Standby.

Note: Most technical errors require the attention of a service technician.

10.2 HIGH PRIORITY ALARMS

Alarm Message	Possible causes	Remedies
<i>Apnea</i>	Preset or default alarm limit exceeded. Time between two consecutive inspiratory efforts exceeds the set alarm limit.	Check patient and breathing system. Check ventilator settings.
<i>Check tubing</i>	Problems with patient tubing or expiratory pressure transducer. Disconnected pressure transducer (expiratory or inspiratory). Blocked pressure transducer (expiratory or inspiratory). Water in expiratory limb of ventilator. Wet or clogged bacteria filter. Excessive leakage.	Refer to service. Remove water from tubing and check humidifier settings, e.g., relative humidity. Check heater wires in humidifier (if present). Check connections of tubing and expiratory cassette.
Check catheter position/Edi invalid	Backup ventilation is active due to invalid Edi signal.	Check the Edi Catheter position.
Check catheter position/RR and HR coupling	Backup ventilation is active due to interference of the ECG signal with the Edi signal.	Check the Edi Catheter position.
Check Heliox adapter	Measured HeO ₂ pressure above 3.5 kPa x 100 (50 psi)	Check that the Heliox adapter is properly connected to the Air inlet. If the problem persists contact a service technician
Edi monitoring not active	NAVA mode is activated when no Edi Module is connected.	Insert the Edi Module.
<i>Expiratory cassette disconnected</i>	The expiratory cassette is disconnected or not connected properly.	Connect the expiratory cassette. Replace the expiratory cassette. Perform a Pre-use check if a new expiratory cassette is inserted.
<i>Expiratory Minute Volume: High</i>	Preset or default alarm limit exceeded. Increased patient activity. Ventilator self-triggering (autocycling). Improper alarm limit setting.	Check patient and breathing system. Check trigger sensitivity setting. Check alarm limit settings.
<i>Expiratory Minute Volume: Low</i> (Also see note at the end of this table)	Preset or default alarm limit exceeded. Note: This alarm also works as a patient disconnect alarm. Low spontaneous patient breathing activity. Leakage around the cuff. Leakage in the patient breathing system. Improper alarm setting.	Check patient Check cuff pressure. Check patient breathing system (perform leakage test if necessary). Check pause time and graphics to verify. Consider increased ventilatory support for the patient.
<i>Gas supply pressures: Low</i>	Air/HeO ₂ and O ₂ supply is below 2.0 kPa x 100. Air/HeO ₂ and O ₂ gas supply disconnected.	Check the gas connections.

Alarm Message	Possible causes	Remedies
<i>High continuous pressure</i>	Obstruction leading to constant high airway pressure (>PEEP +15 cmH ₂ O) during: <ul style="list-style-type: none"> ■ > 2 breaths or 5 seconds, whichever is greater, ■ 15 ±1.5 s if less 2 breaths are triggered 	Check patient and breathing system. Check ventilator settings. Contact a service technician.
<i>Leakage out of range</i> (A high priority alarm when NIV disconnect flow is enabled). See section Medium priority alarms.	Leakage too high. The mask / prongs / helmet may not be adjusted properly for the patient or may be the wrong size.	Check patient and breathing system. Check mask/ prongs size and patient fit. Check the helmet leakage.
<i>Low battery voltage</i>	Battery voltage too low. Cannot guarantee continued ventilator operation.	If possible, connect to AC power supply. Replace and discard all batteries if this message appears even when batteries are fully charged.
<i>Nebulizer hardware error</i>	Technical problem with nebulizer hardware. Temperature too high.	Change the nebulizer. Contact a service technician.
<i>No battery capacity</i>	Less than 3 minutes left of battery operation.	Connect to AC power. Insert charged battery modules.
<i>No consistent patient effort</i>	The ventilator has switched between supported and backup ventilation four times in two minutes. The patient has only triggered a single breath to interrupt each of two consecutive backup periods	Check patient and breathing system. Check ventilator settings.
<i>No patient effort</i>	An apnea has caused the ventilator to switch to backup ventilation.	Check patient and breathing system. Check ventilator settings.
<i>O₂ cell / sensor failure</i>	O ₂ cell / sensor missing or disconnected.	Check O ₂ cell / sensor and connection.
<i>O₂ concentration: High</i>	Measured O ₂ concentration exceeds the set value by more than 5 Vol.%. Gas supply or air line disconnected. No supply from wall outlet. The air gas module is disconnected. If no gas is available, then both expiratory and safety valves will open.	Check air/HeO ₂ supply Perform a Pre-use check. Perform O ₂ cell adaptation.

Alarm Message	Possible causes	Remedies
<i>O₂ concentration: Low</i>	<p>Measured O₂ concentration is below the set value by more than 5 Vol.% or concentration is below 18 Vol.% which is independent of operator settings.</p> <p>Gas delivered in O₂ supply line is not O₂.</p> <p>O₂ sensor faulty or exhausted.</p> <p>O₂ cell uncalibrated.</p> <p>O₂/oxygen gas module faulty.</p>	<p>Check O₂ supply line.</p> <p>Perform a Pre-use check.</p> <p>Perform O₂ cell adaptation.</p>
Paw high	<p>Airway pressure exceeds preset Upper Pressure Limit.</p> <p>Kinked or blocked tubing.</p> <p>Mucus or secretion plug in endotracheal tube or in airways.</p> <p>Patient coughing or fighting ventilator.</p> <p>Inspiratory flow rate too high.</p> <p>Improper alarm setting.</p> <p>Blocked expiratory filter.</p>	<p>Check patient and breathing system.</p> <p>Check ventilator settings and alarm limits.</p>
Pneumatic-Edi out of synch	The measured Edi signal is completely out of phase compared with the pressure and flow signals generated by the patient.	<p>Check the Edi Catheter position.</p> <p>Check/adjust the trigger settings.</p> <p>Change ventilation mode.</p>
<i>Restart ventilator!</i>	Software error.	<p>Restart the ventilator and perform a Pre-use check.</p> <p>Contact a service technician.</p>
<i>Safety valve test failed</i>	During Pre-use check the system found problems with the opening pressure for the safety valve.	Contact a service technician.
<i>Settings lost; Restart ventilator</i>	Software error, memory corrupt.	<p>Restart the ventilator and perform a Pre-use check.</p> <p>Check ventilator settings.</p>
Technical error in Expiratory cassette	Technical problem with the expiratory cassette.	<p>Perform a Pre-use check.</p> <p>Change the expiratory cassette and perform a Pre-use check.</p> <p>Contact a service technician.</p>
Technical error: Restart ventilator	Ventilator settings lost.	<p>Restart the ventilator, perform a Pre-use check and check all settings.</p> <p>Contact a service technician.</p>
Time in waiting position exceeds 2 min.	<p>Time in waiting position is exceeded.</p> <p>Patient is not connected to the ventilator or leakage is excessive.</p>	Check patient and breathing system.

See the following Note.

Note: Considerable leakage may occur around the endotracheal tube if it is uncuffed. The combination of small tidal volumes, leakage around the tube, and activated compliance compensation may trigger the Low Expiratory Minute Volume alarm due to a very low expiratory flow passing from the patient through the expiratory channel. By observing the difference between the V_{ti} and V_{te} values presented on the user interface, a leakage can be detected and its extent easily controlled. The first time an unacceptably large leakage occurs around the tube, correct this problem to avoid triggering the Low Expiratory Minute Volume alarm. If the leakage persists, either adjust the alarm limit down to its lowest level (10 ml) or permanently silence the alarm (see page 177)—if this step is clinically appropriate. Finally, if the leakage still has not been remedied, deactivate the compliance compensation to avoid triggering the alarm. If the compliance compensation is deactivated while in Pressure Control, Pressure Support, or SIMV (Pressure Control) ventilation modes, then no further settings need to be adjusted. However, in volume-related modes, the set volumes must be adjusted.

10.3 MEDIUM PRIORITY ALARMS

Alarm Message	Possible causes	Remedies
Air supply pressure: High	Air supply pressure above 6.0 kPa x 100 (87 psi) Air supply pressure at gas inlet is too high.	Check the gas supply lines. Perform a Pre-use check. Contact a service technician.
Air supply pressure: Low	Air supply pressure below 2.0 kPa x 100 (29 psi) Air supply pressure at gas inlet is too low. Gas supply line disconnected. Note: This alarm can be permanently silenced (Audio off) when activated.	Check and connect gas supply lines. Perform a Pre-use check.
Alarm output connection error	Technical problems (hardware or software) with the external alarm function.	Contact a service technician.
Battery mode! Nebulizer switched off	Ventilator is running on batteries and the Servo Ultra Nebulizer is disabled to reduce power consumption.	Connect to AC power to use the Servo Ultra Nebulizer. Check the connection to AC power.
Check alarm limits	The persistent memory has corrupt contents.	Check the alarm limits.
Check default alarm limits	Problems in internal memory for default alarm limits.	Check default alarm limits. Contact a service technician.
Check Y Sensor	Y Sensor is not connected to the patient breathing system or Y Sensor is not working properly.	Check sensor connection to patient breathing system. Change the Y Sensor.
CO ₂ module error	Hardware error in the CO ₂ Analyzer module.	Unplug and reinsert the module. Change the module. Contact a service technician.
CO ₂ module unplugged	CO ₂ Analyzer module is not properly inserted.	Insert the CO ₂ Analyzer module.
CO ₂ sensor disconnected	CO ₂ capnostat sensor is not attached.	Connect the sensor to the CO ₂ Analyzer module.
CO ₂ sensor error	Hardware error in CO ₂ capnostat sensor. The values in the capnostat memory failed the internal test.	Unplug and reinsert the capnostat sensor. Calibrate the capnostat sensor. Change the capnostat sensor. Contact a service technician.
CO ₂ sensor temperature too high	Possible hardware error. The capnostat sensor temperature is higher than 50°C	Make sure the capnostat sensor is not exposed to extreme heat (heat lamp, incubator etc.). Replace the capnostat sensor.
CO ₂ sensor temperature too low	The capnostat sensor does not reach operating temperature.	Change capnostat sensor and/or module. Contact a service technician.

Alarm Message	Possible causes	Remedies
CPAP High/Low	Preset or default alarm exceeded.	Check patient and breathing system. Check mask/ prongs size and patient fit. Check alarm settings.
<i>etCO₂ high</i>	Hypoventilation. Leakage with high bias flow. CO ₂ sensor, Y-piece, HME.	Check patient circuit. Check ventilator settings.
<i>etCO₂ low</i>	Hyperventilation. Leakage with high bias flow. CO ₂ sensor, Y-piece, HME.	Check patient circuit. Check ventilator settings.
<i>Exp. cassette exchanged</i>	Expiratory cassette has been exchanged during operation. Pre-use check not performed after exchange.	Perform a Pre-use check.
<i>Inspiratory flow overrange</i>	Combination of settings exceeds the allowable inspiration flow range.	Change ventilator settings.
<i>Internal temperature: High</i>	Temperature inside the ventilator is too high.	Check fan operation. Check the operating temperature. Clean the fan filter in the patient unit.
HeO ₂ supply pressure: High	HeO ₂ supply pressure above 6.0 kPa x 100 (87 psi) HeO ₂ supply pressure at gas inlet is too high.	Check the gas supply lines. Perform a Pre-use check. Contact a service technician.
HeO ₂ supply pressure: Low	HeO ₂ supply pressure below 3.4 kPa x 100 (29 psi) HeO ₂ supply pressure at gas inlet is too low. Note: This alarm can be permanently silenced (Audio off) when activated.	Check and connect gas supply lines. Perform a Pre-use check.
<i>Leakage out of range (A medium priority alarm when NIV disconnect flow is disabled). See section High priority alarms.</i>	Leakage too high. The mask / prongs / helmet may not be adjusted properly for the patient or may be the wrong size.	Check patient and breathing system. Check mask/ prongs size and patient fit. Check the helmet leakage.
<i>Limited battery capacity</i>	Less than 10 minutes left of battery operating time.	Insert a new battery module or connect to AC power
<i>Nebulizer disconnected</i>	The nebulizer is disconnected during nebulization. Technical problem with connection cable.	Connect the nebulizer. Change the connection cable.
<i>Nebulizer hardware error</i>	Technical problem with nebulizer hardware. Temperature too high. Not enough buffer liquid. Technical problem with connection cable.	Restart the nebulizer. Check buffer liquid level. Change the nebulizer. Change connection cable. Contact a service technician.
<i>Nebulizer inhibited due to overheating</i>	Temperature too high.	Turn off the nebulizer and restart when cool.

Alarm Message	Possible causes	Remedies
<i>O₂ supply pressure: High</i>	O ₂ supply pressure above 6.0 kPa x 100. O ₂ supply pressure at gas inlet is too high.	Check the gas supply lines. Perform a Pre-use check. Contact a service technician.
<i>O₂ supply pressure: Low</i>	O ₂ supply pressure below 2.0 kPa x 100. O ₂ supply pressure at gas inlet is too low. Gas supply line disconnected. This alarm can be permanently silenced (Audio off) when activated.	Check and connect gas supply lines. Perform a Pre-use check.
<i>Panel disconnected</i>	No communication between user interface and patient unit.	Check control cable. Contact a service technician.
<i>PEEP High</i>	The measured end expiratory pressure is above the preset or default alarm limit for three consecutive breaths.	Check patient breathing system. Check patient connection (cuff pressure/tracheal tube size). Perform a Pre-use check. Check ventilator settings. Check alarm settings.
<i>PEEP Low</i>	The measured end expiratory pressure is below the preset or default alarm limit for three consecutive breaths. Setting the alarm to zero turns the alarm off. Leakage in patient breathing system. Leakage at patient connection (cuff, tracheal tube).	Check patient breathing system. Check patient connection (cuff pressure/tracheal tube size). Perform a Pre-use check. Check alarm settings.
<i>Regulation pressure limited</i>	It is not possible to reach the Set volume in PRVC and VS due to restrictions imposed by the set upper pressure limit. Set high pressure alarm limit; this limits the regulatory pressure used in PRVC or VS	Check ventilator settings.
<i>Remove one CO₂ module</i>	Two CO ₂ Analyzer modules are connected at the same time.	Remove one of the CO ₂ Analyzer modules.
<i>Requested gas type not connected</i>	If more than one minute passes without the set gas type being identified.	Check gas supply.
<i>Respiratory Rate: High</i>	Respiratory rate too high. Auto triggering.	Attend to the patient. Check the trigger setting.
<i>Respiratory Rate: Low</i>	Respiratory rate too low. Trigger sensitivity setting incorrect. Large tidal volume.	Attend to the patient. Check trigger setting. Check inspiratory cycle-off setting.
<i>VT inspiratory overrange</i>	Setting causing larger volume than allowed for the selected category. Limited adjustment of excessive tidal volume.	Check the adjustment for the inspiratory tidal volume.

Alarm Message	Possible causes	Remedies
<i>Y Sensor mismatch</i>	Y Sensor does not match the selected patient category	Check patient category setting. <i>Check Y Sensor</i>
<i>Y Sensor Module disconnected</i>	Y Sensor module is not properly inserted.	Insert the Y Sensor module.
<i>Remove one Y Sensor Module</i>	Two Y Sensor modules are connected at the same time.	Remove one of the Y Sensor modules.
<i>Y Sensor Module error</i>	Hardware error in the Y Sensor measuring module.	Unplug and reinsert the module. Change the module. Contact a service technician.
<i>Y Sensor Module temp high</i>	Possible hardware error. The Y Sensor module temperature is higher than 60°C.	Make sure the Y Sensor module is not exposed to extreme heat. Change the module. Contact a service technician.
<i>Y Sensor disconnected</i>	Y Sensor is not attached.	Connect the sensor to the Y Sensor module.
<i>Edi Module disconnected</i>	Edi Module is not properly inserted.	Insert the Edi Module.
<i>Edi Module error</i>	Hardware error in the Edi Module.	Unplug and re-insert the Edi Module. Change the Edi Module. Contact a service technician.
<i>No Edi Catheter connected</i>	Edi Catheter is not properly connected.	Connect the Edi Catheter properly.
<i>Edi Catheter error</i>	Error in the Edi Catheter.	Perform the Edi Module Test. Replace the Edi Catheter.
<i>No Edi signal detected</i>	The Edi Catheter is not placed properly inside the patient.	Check the Edi Catheter position.
<i>Edi activity low</i>	The measured Edi activity is low during NAVA ventilation.	Check the Edi Catheter position. Adjust the Edi trigger setting. Change ventilation mode.
<i>Remove one Edi Module</i>	Two Edi Modules are connected at the same time.	Remove one Edi Module

10.4 LOW PRIORITY ALARMS

Alarm message	Possible causes	Remedies
<i>Battery operation</i>	AC power interrupted.	Check the connection to AC power.
Leakage fraction too high	Leakage too high. The mask / prongs / helmet may not be adjusted properly for the patient or may be the wrong size.	Check patient and breathing system. Check mask/ prongs size and patient fit. Check the helmet leakage.
<i>Touch screen or knob press time exceeded</i>	Screen or knob has been pressed for more than one minute. Screen or knob hardware time out.	Check screen and knobs. Contact a service technician.

10.5 CO₂ ANALYSER: CALIBRATION ERROR MESSAGES (OPTION)

Message	Description	Remedies
<i>Adapter zero: Failed</i>	An error was detected during the verification calibration (adapter zero). The airway adapter is occluded or CO ₂ gas is present in the adapter. The calibration was cancelled and old cell zero parameters were not restored.	Perform a verification calibration. Contact a service technician.
<i>CO₂ cell zero failed</i>	An error was found during cell zero calibration. The calibration was cancelled and old cell zero parameters were not restored.	Perform a cell zero calibration. Contact a service technician.
<i>Verification against Reference cell: Failed</i>	The capnostat sensor is faulty or there is an optical blockage of the capnostat sensor windows.	Clean the capnostat sensor windows. Replace the capnostat sensor.

10.6 TECHNICAL ERROR MESSAGES

Error code number	Causes	Remedies
<i>xxxx (General)</i>	Technical problem, identified by the error code xxxx.	Restart the ventilator and perform a Pre-use check. Contact a service technician.
<i>1 - 6, 29, 10001</i>	Internal power error.	Contact a service technician.
<i>7, 10-12, 16</i>	Control system error	Contact a service technician.
<i>43</i>	Battery information error	Contact a service technician.
<i>28, 20004</i>	Audible alarm/ loudspeaker error	Check that the loudspeaker outlet is not obstructed. Restart the ventilator and perform a Pre-use check. Contact a service technician.
<i>41</i>	Internal clock error	Contact a service technician.
<i>25, 33-35, 50, 10002, 20001</i>	Internal communication error	Contact a service technician.
<i>38-39</i>	Barometer error	Contact a service technician.
<i>46</i>	Alarm output connection error	Contact a service technician.
<i>8-9, 48-49</i>	Timeout error	Contact a service technician.
<i>22, 24, 27</i>	Backup audible alarm error	Restart the ventilator and perform a Pre-use check. Contact a service technician.
<i>20002</i>	Backlight error	Contact a service technician.
<i>20003</i>	Membrane button error	Check the user interface buttons. Contact a service technician.
<i>51</i>	Technical problem with On/Off switch.	Contact a service technician.
<i>52</i>	O ₂ sensor not compatible with Heliox option	Contact a service technician.
<i>53</i>	Exp. flow meter PC board not compatible with Heliox option.	Contact a service technician.
<i>40001</i>	Exp. flow meter error	Contact a service technician.
<i>40, 42, 44, 45, 50, 54, 10003, 20005</i>	Other error	Restart the ventilator and perform a Pre-use check. Contact a service technician.

11 START-UP CONFIGURATION

TABLE OF CONTENTS

11.1	Introduction	214
11.2	Access the Start-Up Configuration	214
11.3	Edit the Start-up Configuration	215
11.4	Start MCare Remote Service	216

11.1 INTRODUCTION

The ventilator will always start up with the stored Start-Up Configuration. The Start-Up Configuration can be edited, copied, and saved.

You can edit the following Start-Up Configuration settings:

- Patient category (Adult or Infant)
- Type of ventilation - invasive or non invasive (NIV)
- Volume setting
- Breath cycle setting
- Pre/post oxygenation concentration above set O₂ concentration (%)
- Option to deactivate backup ventilation (Disabled or Enabled)
- NIV disconnect function (High flow, Low flow or Disabled)
- Extended leakage test during pre-use check
- Volume Control with alternative flow patterns

This section provides instructions for accessing and editing the start-up configuration, changing the patient category, and changing the type of ventilation.

11.2 ACCESS THE START-UP CONFIGURATION

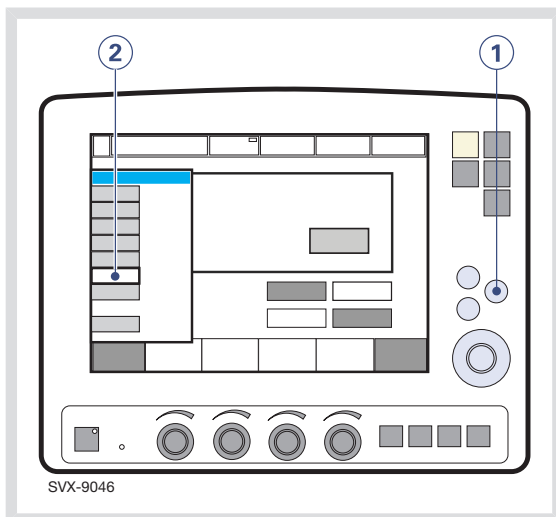

Note: The ventilator must be in Standby.

1. Press the *Menu* fixed key.
2. Press the *Biomed* touchpad and enter the access code (the factory setting is 1973).

The *Biomed* submenu consists of the following touchpads:

- *Service*
- *Edit configuration*
- *Copy configuration*
- *Set date and clock*
- *Change access code*
- *Start Remote Service*

To alter ventilator settings, press the appropriate touchpad and follow on-screen instructions.

11.3 EDIT THE START-UP CONFIGURATION

To edit the Start-up Configuration.

1. Press the *Edit configuration* touchpad in the *Biomed* submenu.
2. Press the *Start-up configuration* touchpad.
3. Press the touchpad for desired start-up setting.
4. Press *Next* to continue to ventilation mode settings.
5. Press the appropriate touchpad to change the settings.

Note: Press *Restore mode settings* to restore factory default settings.

6. Press *Next* to view a summary of the start-up configuration.
7. Press *Accept* to save the start-up settings.

Note: The ventilator must be restarted to activate the new settings.

11.3.1 PROCEDURE DIAGRAM: EDIT THE START-UP CONFIGURATION



11.4 START MCARE REMOTE SERVICE

Connect the network cable between the SERVO-i Ventilator System (1) and the docking station.

WARNING! Only use network equipment that has been installed by a MAQUET representative.

CAUTION: When using the MCare Remote Service function, install the network cable so that there is no risk of anyone tripping over it.

Activate the MCare Remote Service function by pressing the *Start MCare Remote Service* touchpad (2) in the *Biomed* window.

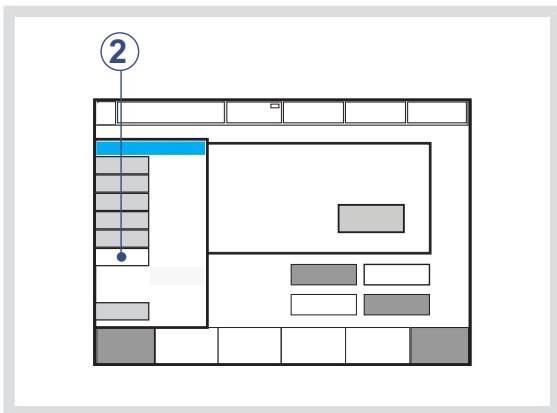

The following message appears in Standby (3) - *MCare Remote Service is activated. Make sure the network cable is connected and Progress: Waiting for transfer....*, followed by *Sending log files.*

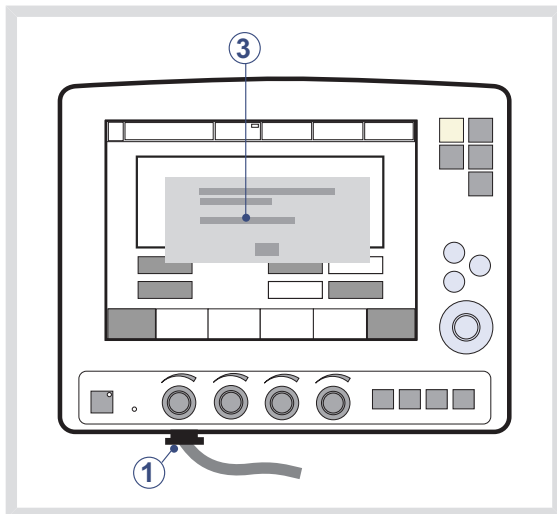

When the transfer is finished, the message *The file transfer is completed. MCare Remote Service will be deactivated. Disconnect the network cable.*

Accept the dialog by pressing *OK* and the MCare Remote Service is deactivated.

WARNING! Always disconnect the network cable before starting ventilation.

Note: The SERVO-i Ventilator System is prepared for the MCare Remote service functionality, although additional equipment is needed to utilise this function. Please contact your sales and service representative for more details.

12 TECHNICAL DATA

TABLE OF CONTENTS

12.1	System	218
12.2	Ventilator	220
12.3	Standard condition specification	221
12.4	Patient circuit	222
12.5	Inspiratory channel	223
12.6	Expiratory channel	224
12.7	Monitoring	225
12.8	Breathing parameters	228
12.9	Alarms	231
12.10	Functions in ventilation modes	233
12.11	Trend function	234
12.12	Open lung tool trend (option)	235
12.13	Log function	235
12.14	Immediate functions	235
12.15	Communication/interface	235
12.16	Service	236
12.17	Servo ultra nebulizer (option)	237
12.18	Aeroneb Micropump Nebulizer (option)	238
12.19	CO ₂ analyzer (option)	239
12.20	Y Sensor measuring (option)	242
12.21	NAVA (option)	243
12.22	Accessories	243
12.23	Health and Environment	245
12.24	Information required by ISO 80601-2-12	246
12.25	UDI Label	248

12.1 SYSTEM

12.1.1 GENERAL

Standards

- EN/IEC 60601-1: 2005, continuous operation
- ISO 80601-2-12:2011
- ISO 80601-2-55:2011

Electromagnetic compatibility (EMC)

According to IEC 60601-1-2:2007

The EMC declaration: *Information to the Responsible Organization* is available from MAQUET.

Patient Range (kg)

- Adult weight: 10 - 250
- Infant weight: 0.5 - 30
- NIV (PC + PS) Infant weight: 3 - 30
- NIV Nasal CPAP Infant weight: 0.5 - 10
- NIV NAVA Infant weight: 0.5 - 30

IP classification

IP 21²

The IP 21 classification implies that the enclosure is protected against solid foreign objects represented by a test finger with a diameter of 12 mm pressed with a force of 10 N, and a sphere with a diameter of 12.5 mm pressed with a force of 30 N against all openings in the enclosure, as well as dripping water with a flow rate of 1 ml/min for ten minutes.

Noise

- A-weighted sound pressure level (L_{pA}): <41 dB, measured at a distance of 1 m
- A-weighted sound power level (L_{WA}): <50 dB

12.1.2 OPERATING CONDITIONS

- Operating Temperature range: +10 to +40°C
- Relative humidity: 15 to 95% non-condensing
- Atmospheric pressure: 660 to 1060 hPa
- Lowest pressure in patient circuit: -400 cmH₂O

Mechanical strength

Vibration, shock and fall according to specified standards with the addition of impact below.

- Peak acceleration: 15 g
- Pulse duration: 6 ms
- Number of impacts:1000

12.1.3 NON OPERATING CONDITIONS

- Storage temperature: -25 to +60°C (-13 to 140°F)
- Storage relative humidity: < 95%.
- Storage atmospheric pressure: 470 – 1060 hPa

2. from serial no. 70001

12.1.4 POWER SUPPLY

Power supply, automatic range selection

- 100-120V, 220-240V, AC 50-60Hz
- Allowed fluctuations $\pm 10\%$ from nominal voltage.

Battery backup

- 2– 6 battery modules rechargeable 12 V, 5A, 3.5 Ah each.
- Recharge time approximately 3 h/battery (up to 12 hours if battery is completely discharged)
- Battery backup time approximately 3 h, when using 6 fully charged batteries.

External 12V DC

12.0 V – 15.0 V DC, 10 A

Fuse: 10 A/32 V Miniblade



Information regarding connector wiring and EMC performance is available from MAQUET.

CAUTION: When using external 12V DC, at least two installed battery modules are required to ensure proper operation.

Max power consumption

- At 110-120V: 2A, 190VA, 140W.
- At 220- 240V: 1A, 190VA, 140W.

On/Off switch (Set to On; when off, battery continues to charge)

Battery lifetime

2.5 years from manufacture date

Storage temperature

15 - 20°C (59 - 68°F)

12.2 VENTILATOR

12.2.1 GENERAL

Dimensions (mm)

- Patient Unit: W 300 x D 205 x H 415
- User Interface: W 355 x D 53 x H 295
 - Screen type: TFT-LCD module
 - Screen size: 31 cm (12.1") diagonal
 - Viewing area: 246.0 x 184.5 mm

Weight, approximate (kg)

- Total: 20
- User Interface: 5
- Patient Unit: 15

Triggering method

- Flow, pressure and Edi

12.2.2 GAS SUPPLY

Gas quality

Supplied gases shall meet the requirements for medical grade gases according to applicable standards.

Maximum levels:

Air

- $H_2O < 7 \text{ g/m}^3$
- $\text{Oil} < 0.5 \text{ mg/m}^3$
- Chlorine: must not be detectable³

O₂

- $H_2O < 20 \text{ mg/m}^3$
- $\text{Oil} < 0.3 \text{ mg/m}^3$

HeO₂

- $H_2O < 100 \text{ mg/m}^3$

Inlet gas

Air/O₂

- Pressure: 2.0 – 6.0 kPa x 100 (29 – 87 psi)
- $\dot{V}_{\text{max}} 60 \text{ l/min}$

HeO₂

- Pressure: 3.4 – 6.0 kPa x 100 (49 – 87 psi)
- $\dot{V}_{\text{max}} 60 \text{ l/min}$

Connection standards available

AGA, DISS, NIST, or French.

Unavailable gas/loss of gas pressure

The flow from an unavailable gas (O₂, air or HeO₂) is automatically compensated for so that the patient gets the preset volume and pressure.

12.2.3 PATIENT SYSTEM CONNECTORS

Conical fittings (mm)

Male 22 and female 15, in accordance with ISO 5356-1.

Gas exhaust port (mm)

Male 30 cone.

12.2.4 USER INTERFACE

Attaches to the mobile cart, a table, railing, or 15-30 mm diameter pipe.

3. If the compressed air is generated by a liquid ring compressor there is a potential risk of chlorine in the supplied air.

12.3 STANDARD CONDITION SPECIFICATION

Inaccuracy ranges in this document assume the following standard conditions and the worst case, i.e. all errors are summarized positive. Statistically 95% of all values will be within 2/3 of the given error.

- Ambient pressure: 101.3 kPa
 - Room temperature: 20 °C
 - Inlet pressure: 4.3 kPa x 100
 - Pre-use check performed on a warmed up ventilator
 - Pre-use check performed with ≥ 99 % oxygen content in O₂ supply.
 - Pre-use check performed with 21 ± 0.5 % oxygen content in air/HeO₂ supply (to ensure specified O₂ monitoring inaccuracy).
 - Patient circuit compliance compensation is activated.
 - Default settings unless otherwise specified
 - All measured, preset and indicated flows and volumes are referenced to BTPS, see chapter Definitions on page 249.
 - All measured, inlet gas pressures and flows are referenced to STPD, see chapter Definitions on page 249.
 - Humidifier water level is between 50 % and 100 % of the maximum level. For tidal volumes below 50 ml, a humidifier with auto fill is used.
 - Set I:E is less than 1:1.
 - Set ventilatory frequency is less than or equal to 100 breaths/minute.
 - Inaccuracy does not include measurement uncertainty. Values including measurement uncertainty are specified in the service documentation available from MAQUET.
- Constant leakage fraction below 30 % in NIV modes.

12.4 PATIENT CIRCUIT

The patient circuit configurations are intended to provide the following range of inspired tidal volumes:

- Adult: 22 mm tubing, Tidal Volumes 100 - 4000 ml.
- Infant: 15 mm tubing, Tidal Volumes 25 - 350 ml.
- Infant: 10-12 mm tubing, Tidal Volumes 2 - 100 ml.

For information regarding patient circuit configurations to be used with SERVO-i Ventilator System, see System Flow Chart, Ventilation, Patient Connection, part no. 66 92 522.

12.4.1 PATIENT CIRCUIT TEST

In the Pre-use check, the patient circuit is tested to determine if it is within these recommended ranges. If the tested parameters are within the specified ranges, the inaccuracies stated are maintained.

Adult patient circuit

- Inspiratory resistance: 0 - 8.5 cmH₂O/l/s at flow rate 60 l/min
- Expiratory resistance: 0 - 8.5 cmH₂O/l/s at flow rate 60 l/min
- Compliance: 0.5 - 5.0 ml/cmH₂O at airway pressure 50 cmH₂O.

Infant patient circuit

- Inspiratory resistance: 0 - 30.0 cmH₂O/l/s at flow rate 10 l/min
- Expiratory resistance: 0 - 25.0 cmH₂O/l/s at flow rate 10 l/min
- Compliance: 0.1 - 2.5 ml/cmH₂O at airway pressure 50 cmH₂O.

The limits used in the presentation under *Status>Patient Circuit* are adjusted for measurement inaccuracy.

12.5 INSPIRATORY CHANNEL

Pressure drop

Maximum: 6 cmH₂O at a flow of 60 l/min

Internal compressible factor

Maximum: 0.1 ml/cmH₂O

Gas delivery system

Microprocessor controlled valves

Gas delivery device

Flow range:

- Adult: 0-3.3 l/s
- Infant: 0-0.55 l/s

Inaccuracy: $\pm(0.1 \text{ ml/s} + 5 \% \text{ of set value})$

Maximum pressure setting:

- Adult: 120 cmH₂O
- Infant: 80 cmH₂O

Inaccuracy: $\pm(1 \text{ cmH}_2\text{O} + 5 \% \text{ of set value})$

Maximum airway pressure

125 cmH₂O

NIV max. leakage compensation level

- Adult: 65 l/min
- Infant: 25 l/min
- Infant Nasal CPAP: 10 l/min

O₂ concentration

- Setting range: 21 - 100%
- Inaccuracy $\pm 3 \text{ vol}\%$.
- Add $\pm 2 \text{ vol}\%$ inaccuracy when HeO₂ is used.

Inspiratory Minute Volume

Air/O₂

- *Adult*
Setting range: 0.5 - 60 l/min
Inaccuracy $\pm(0.18 \text{ l/min} + 7 \% \text{ of set value})$ ⁴
- *Infant*
Setting range: 0.3 - 20 l/min
Inaccuracy $\pm(0.15 \text{ l/min} + 7 \% \text{ of set value})$ ⁵

HeO₂/O₂

- *Adult*
Setting range: 0.5 - 60 l/min
Inaccuracy $\pm(0.18 \text{ l/min} + 10 \% \text{ of set value})$ ⁶
- *Infant*
Setting range: 0.3 - 20 l/min
Inaccuracy $\pm(0.15 \text{ l/min} + 10 \% \text{ of set value})$ ⁷

Inspiratory Tidal Volume

Air/O₂

- *Adult*
Setting range: 100 - 2000/4000 ml⁸
Inaccuracy: $\pm(4 \text{ ml} + 7 \% \text{ of set volume})$
- *Infant*
Setting range: 2 - 350 ml
Inaccuracy:
- $\pm(4 \text{ ml} + 7 \% \text{ of set volume})$ for VT > 50 ml
- $\pm(2 \text{ ml} + 7 \% \text{ of set volume})$ for VT ≤ 50 ml

4. at RR <45 b/min

5. at RR <75 b/min

6. at RR <45 b/min

7. at RR <75 b/min

8. 100 - 2000 (Adult), 100 - 4000 (Universal)

HeO₂/O₂

■ *Adult*

Setting range: 100 - 2000/4000 ml⁹

Inaccuracy: $\pm(4 \text{ ml} + 10 \% \text{ of set volume})$

■ *Infant*

Setting range: 2 - 350 ml

Inaccuracy:

$\pm(4 \text{ ml} + 10 \% \text{ of set volume})$ for VT > 50 ml

$\pm(2 \text{ ml} + 11 \% \text{ of set volume})$ for VT \leq 50 ml

12.6 EXPIRATORY CHANNEL

Pressure Drop

Maximum: 3 cmH₂O at a flow of 60 l/min

Internal Compressible Factor

Maximum: 0.1 ml/cmH₂O

PEEP Regulation

Microprocessor controlled valve

PEEP setting range:

- PEEP setting range 0 - 50 cmH₂O

Inaccuracy: $\pm(1 \text{ cmH}_2\text{O} + 5 \% \text{ of set value})$ ¹⁰

Expiratory Flow Measurements

- 0 - 3.2 l/s
- Rise time (flow of 0.05 - 3.2 l/s): <12 ms for 10 - 90% response

Bias flow during expiration

- Adult: 2 l/min.
- Infant: 0.5 l/min.

9. 100 - 2000 (Adult), 100 - 4000 (Universal)

10. PEEP accuracy may decrease for RR \geq 60 b/min together with V_T \leq 20 ml.

12.7 MONITORING

Inspiratory Tidal Volume

In the infant setting, tidal volume range in volume controlled and volume supported modes is 2-350 ml. When the tidal volume is set below 5 ml, use of Y Sensor measuring is recommended to optimize monitoring of volumes (not possible during HeO₂ use).

Inspiratory Tidal Volume

Air/O₂

■ Adult

Range: 0 - 2000/4000 ml¹¹

Inaccuracy: $\pm(4 \text{ ml} + 7 \% \text{ of actual volume})$
for V_T 100 ml - 4000 ml

Inaccuracy with Y Sensor:

- $\pm(4 \text{ ml} + 6 \% \text{ of actual volume})$ for V_T
100 ml - 4000 ml

■ Infant

Range: 0 - 350 ml

Inaccuracy:

- $\pm(2 \text{ ml} + 10 \% \text{ of actual volume})$ for V_T
20 ml - 350 ml
- $\pm(2 \text{ ml} + 10 \% \text{ of actual volume})$ for V_T
2 ml - 20 ml

Inaccuracy with Y Sensor:

- $\pm(2 \text{ ml} + 7 \% \text{ of actual volume})$ for V_T
20 ml - 350 ml
- $\pm(2 \text{ ml} + 10 \% \text{ of actual volume})$ for V_T
2 ml - 20 ml

HeO₂/O₂

■ Adult

Range: 0 - 2000/4000 ml¹²

Inaccuracy: $\pm(4 \text{ ml} + 10 \% \text{ of actual volume})$
for V_T 100 ml - 4000 ml

■ Infant

Range: 0 - 350 ml

Inaccuracy:

- $\pm(4 \text{ ml} + 10 \% \text{ of actual volume})$ for V_T
20 ml - 350 ml
- $\pm(4 \text{ ml} + 10 \% \text{ of actual volume})$ for V_T
2 ml - 20 ml

Expiratory Minute Volume

Air/O₂

■ Adult

Range: 0 - 60 l/min

Inaccuracy: $\pm(0.18 \text{ l/min} + 8 \% \text{ of actual value})$ ¹³

■ NIV: $\pm 10\%$

■ Infant

Range: 0 - 20 l/min

Inaccuracy: $\pm(0.2 \text{ l/min} + 10\% \text{ of actual value})$ ¹⁴

■ NIV: $\pm 10\%$

■ NIV Nasal CPAP: $\pm(0.15 \text{ l/min} + 25 \% \text{ of actual value})$

11. 0-2000 (Adult), 0-4000 (Universal)

12. 0-2000 (Adult), 0-4000 (Universal)

13. at RR <45 b/min

14. at RR <75 b/min

HeO₂/O₂

■ *Adult*

Range: 0 - 60 l/min

Inaccuracy: $\pm(0.18 \text{ l/min} + 15 \% \text{ of actual value})$ ¹⁵

■ NIV: $\pm 15\%$

■ *Infant*

Range: 0 - 20 l/min

Inaccuracy: $\pm(0.15 \text{ l/min} + 15 \% \text{ of actual value})$ ¹⁶

■ NIV: $\pm 15\%$

■ NIV Nasal CPAP: $\pm(0.25 \text{ l/min} + 25 \% \text{ of actual value})$

Expiratory Tidal Volume

Air/O₂

■ *Adult*

Range: 0 - 2000/4000 ml¹⁷

Inaccuracy: $\pm(4 \text{ ml} + 8 \% \text{ of actual volume})$
for V_T 100 ml - 4000 ml

Inaccuracy with Y Sensor:

- $\pm(4 \text{ ml} + 8 \% \text{ of actual volume})$ for V_T
100 ml - 4000 ml

■ *Infant*

Range: 0 - 350 ml

Inaccuracy:

- $\pm(2.5 \text{ ml} + 9 \% \text{ of actual volume})$ for V_T
>20 ml - 350 ml

- $\pm(2.5 \text{ ml} + 10 \% \text{ of actual volume})$ for V_T
2 ml - 20 ml

Note: For V_T <20 ml the used patient breathing circuit shall have a compliance below 1.2 ml/cmH₂O.

Inaccuracy with Y Sensor:

- $\pm(2 \text{ ml} + 8 \% \text{ of actual volume})$ for V_T
20 ml - 350 ml

- $\pm(2 \text{ ml} + 10 \% \text{ of actual volume})$ for V_T
2 ml - 20 ml

HeO₂/O₂

WARNING! Additional patient monitoring (e.g. SpO₂, CO₂) is needed when ventilating patients in Infant patient category with a tidal volume below 100 ml due to reduced expiratory measurement accuracy.

■ *Adult*

Range: 0 - 2000/4000 ml¹⁸

Inaccuracy: $\pm(4 \text{ ml} + 15 \% \text{ of actual volume})$
for V_T 100 ml - 4000 ml

■ *Infant*

■ Range: 0 - 350 ml

■ Inaccuracy:

- $\pm(2.5 \text{ ml} + 15 \% \text{ of actual volume})$ for
V_T >20 ml - 350 ml

Respiratory rate

■ Range: 1 - 160 b/min

■ Inaccuracy:

- $\pm 1 \text{ b/min}$

- 10 % in Nasal CPAP

15. at RR <45 b/min

16. at RR <75 b/min

17. 0-2000 (Adult), 0-4000 (Universal)

18. 0-2000 (Adult), 0-4000 (Universal)

O₂ Concentration

- Range: 0 – 100%
- Inaccuracy: $\pm(2.5 \text{ vol\%} + 2.5 \text{ \% of actual gas concentration})$
- Stability (within 8-hour period): $\pm(2.5 \text{ \% volume} + 2.5 \text{ \% of actual gas concentration})$

The inaccuracy of the measurement is dependant on the oxygen content of the supplied gases during the Pre-use check.

Add $\pm 2 \text{ vol\% O}_2$ measuring tolerance if an HeO₂ gas deviating from 21% O₂ content is used for the Pre-use check (i.e. 80/20, 78/22 HeO₂)

An increased deviation in measured O₂ concentration may be seen during HeO₂ delivery in infant range.

System response time O₂

The total system response time of the O₂ monitor when exposed first to air and then to a gas mix with 60 % O₂ is <20 s.

Barometric pressure compensation

Automatic

Airway Pressure

- Range: -40 - 160 cmH₂O
- Inaccuracy: $\pm(1 \text{ cmH}_2\text{O} + 5 \text{ \% of actual value})$

Supply Pressure

- Range: 0 - 7 bar
- Inaccuracy: $\pm 5\%$ of read value

Filtering

- Pressure waveform: Low pass filtered (time constant 15 ms)
- CO₂ waveform: Low pass filtered (time constant 15 ms)

The measured and calculated values displayed or used for control have in some cases been subjected to filtering and smoothing techniques. This is done to capture the important patterns in the data while excluding noise and make the data shown clinically relevant. These techniques are part of the inaccuracy specified in the technical data.

12.8 BREATHING PARAMETERS

Parameter	Factory set default values (Standard configuration)		Setting range	
	Infant	Adult	Infant	Adult
Automode ON/OFF	OFF	OFF	ON/ OFF	ON/ OFF
Automode trigger timeout (s)	3	7	3 – 15	7 - 12
Bias flow (l/min)	0.5	2	-	-
Breath cycle time, SIMV (s)	1	4	0.5 - 15	1 - 15
CMV frequency (b/min)	30	15	4 - 150	4 - 100 (4 - 150 in Universal)
Compensate for compliance	OFF	OFF	ON/ OFF	ON/ OFF
CPAP (cmH ₂ O) in NIV Nasal CPAP	5	-	2 - 20	-
Edi Trigger (µV)	0.5	0.5	0.1 – 2.0	0.1 – 2.0
Flow trig sensitivity level (fraction of bias flow)	50%	50%	0-100%	0-100%
I:E ratio	1:2	1:2	1:10 - 4:1	1:10 - 4:1
I:E ratio in backup	1:2	1:2	1:10 - 4:1	1:10 - 4:1
Inspiratory cycle-off (% of peak flow)	30	30	1 - 70	1 - 70
Inspiratory cycle-off (% of peak flow) in NIV	30	50	10 - 70	10 - 70
Inspiratory rise time (%)	5	5	0 - 20	0 - 20
Inspiratory rise time (s)	0.15	0.15	0 - 0.2	0 - 0.4
Inspiratory rise time (s) in NIV	0.15	0.2	0 - 0.2	0 - 0.4
Maximum inspiratory flow (l/s)	0.56	3.3	-	-
Maximum permitted absolute pressure (cmH ₂ O)	80	120	-	-

Parameter	Factory set default values (Standard configuration)		Setting range	
	Infant	Adult	Infant	Adult
Maximum permitted absolute pressure in NIV (cmH ₂ O)	32	32	-	-
Minute Volume (l/min)	2.0	7.5	0.3 - 20	0.5-60
Mode (in NIV)	PS	PS	-	-
Mode (Invasive ventilation)	PC	VC	-	-
NAVA level (cmH ₂ O/μV)	1.0	1.0	0.0 - 15.0	0.0 - 15.0
Nebulizer	OFF	OFF	ON/ OFF	ON/ OFF
Nebulizer time (min)	10	10	5 - 30, continuous nebulization	5 - 30, continuous nebulization
NAVA level in NIV (cmH ₂ O/μV)	0.5	0.5	0.0 - 15.0	0.0 - 15.0
O ₂ concentration (%)	40	40	21 - 100	21 - 100
PEEP (cmH ₂ O)	5	5	0 - 50	0 - 50
PEEP in NIV (cmH ₂ O)	5	5	2 - 20	2 - 20
Phigh (cmH ₂ O)	15	15	(PEEP+1) - 50	(PEEP+1) - 50
Press trig sensitivity level (cmH ₂ O)	-	-	-20 - 0	-20 - 0
Pressure level above PEEP (cmH ₂ O)	20	20	0 - (80 -PEEP)	0 - (120 -PEEP)
Pressure level above PEEP in NIV (cmH ₂ O)	5	5	0 - (32-PEEP)	0 - (32-PEEP)
Pressure level above PEEP in backup (cmH ₂ O)	10	20	5- (80 -PEEP)	5- (120 -PEEP)
Pressure level above PEEP in NIV backup (cmH ₂ O)	5	5	5 - (32 - PEEP)	5 - (32 - PEEP)
PS above PEEP in Bi-Vent/APRV (cmH ₂ O)	0	0	0 - (80-PEEP)	0 - (120 -PEEP)
PS above Phigh in Bi-Vent/APRV (cmH ₂ O)	0	0	0 - (80-P _{High})	0 - (120 - P _{High})

Parameter	Factory set default values (Standard configuration)		Setting range	
	Infant	Adult	Infant	Adult
Resp rate in backup	30	15	4 - 150	4 - 100 (4 - 150 in Universal)
SIMV frequency (b/min)	20	5	1 - 60	1 - 60
Thigh (s)	1	2	0.2 - 30 s	0.2 - 30 s
Ti (s)	0.5	0.9	0.1 - 5	0.1 - 5
Ti in backup (s)	0.5	0.9	0.1 - 5	0.1 - 5
Tidal Volume (ml)	80	500	2 – 350	100 - 2000 (100 - 4000 in Universal)
Tidal volume in backup (ml)	80	500	2 – 350	100 - 2000 (100 - 4000 in Universal)
Tpause (%)	10	10	0 – 30	0 – 30
Tpause (s)	0.2	0.4	0 - 1.5	0 - 1.5
TPEEP (s)	1	2	0.1 - 10 s	0.1 - 10 s
Weight (kg)	3	50	0.5 - 30	10- 250

12.9 ALARMS

12.9.1 ALARM LIMITS

Parameter	Factory set default		Setting range		Audio Off (only for NIV)
	Infant	Adult	Infant	Adult	
Airway pressure, upper limit (cmH ₂ O) ¹⁹	40	40	16 - 90	16 - 120	No
Airway pressure, upper limit (cmH ₂ O) in NIV ²⁰	20	20	16 - 40	16 - 40	No
Apnea time to alarm (s) ²¹	10	20	2 - 45	15 - 45	No
Apnea audio delay	-	-	0 - 30	-	-
Nasal CPAP high limit (cmH ₂ O)	7	-	0 - 25	-	Yes
Nasal CPAP lower limit (cmH ₂ O) Note: Setting the alarm to zero turns off the alarm	3	-	0 - 25	-	Yes
End expiratory pressure, high limit (cmH ₂ O) ²²	10	10	0 - 55	0 - 55	Yes
End expiratory pressure, lower limit (cmH ₂ O)	2	2	0 - 47 ²³	0 - 47	Yes
Expired minute volume, lower limit (l/min)	2.0	5.0	0.01-20.0	0.5 - 40.0	Yes
Expired minute volume, upper limit (l/min)	5.0	40.0	0.01-30.0	0.5 - 60.0	Yes
Respiratory rate, lower limit (b/min)	20	5	1 - 160	1 - 160	Yes
Respiratory rate, upper limit (b/min)	50	30	1 - 160	1 - 160	Yes
etCO ₂ Lower alarm limit					
%	4.0	4.0	0.5 - 20	0.5 - 20	-
mmHg	30	30	4 - 100	4 - 100	-

19. If P_{aw} rises 6 cmH₂O above the set limit or if system pressure exceeds 117 ±7 cmH₂O, the safety valves opens.

20. If P_{aw} rises 6 cmH₂O above the set limit or if system pressure exceeds 117 ±7 cmH₂O, the safety valves opens.

21. The apnea alarm can be turned off in Nasal CPAP

22. Setting the alarm limit to 0 (zero) is equivalent to turning off the alarm.

23. Setting the alarm to 0 (zero) is equal to alarm off

Parameter	Factory set default		Setting range		Audio Off (only for NIV)
	Infant	Adult	Infant	Adult	
kPa	4.0	4.0	0.5 - 14	0.5 - 14	-
etCO ₂ Lower alarm limit in NIV ²⁴					
%	4.0	4.0	0 - 20	0 - 20	Yes
mmHg	30	30	0 - 100	0 - 100	Yes
kPa	4.0	4.0	0 - 14	0 - 14	Yes
etCO ₂ Upper alarm limit ²⁵					
%	6.5	6.5	0.5 - 20	0.5 - 20	Yes
mmHg	49	49	4 - 100	4 - 100	Yes
kPa	6.5	6.5	0.5-14	0.5-14	Yes
O ₂ concentration, Air	-	-	Set value - 5 vol% or ≤ 18 vol%		No
O ₂ concentration, HeO ₂	-	-	Set value - 7 vol% or ≤ 18 vol%		No
Gas supply, Air/O ₂	<2.0 kPa x 100 or >6.0 kPa x 100		-	-	-
Gas supply, HeO ₂	<3.4 kPa x 100 or >6.0 kPa x 100		-	-	-
High continuous pressure	-	-	Obstruction leading to constant high airway pressure (>PEEP +15 cmH ₂ O) during: <ul style="list-style-type: none"> ■ > 2 breaths or 5 seconds, whichever is greater, ■ 15 ±1.5 s if less 2 breaths are triggered 		No

24. In NIV low limit can be set to 0 (zero)

25. If the alarm limit is set outside the measuring range, no alarm will be activated even if the limit is exceeded.

Default values are set when:

- restarting the ventilator
- admitting a new patient
- changing type of ventilation (option)
- changing patient category (option)
- the ventilator has been totally without power for more than 2 minutes.

Always make sure relevant values are set.

12.9.2 AUTOSSET ALARM LIMITS - CONTROLLED MODES ONLY

High Airway Pressure

Mean peak pressure +10 cmH₂O or at least 35 cmH₂O

Expiratory Minute Volume (Upper alarm limit)

+ 50%

Expiratory Minute Volume (Lower alarm limit)

- 50%

Respiratory rate (Upper alarm limit)

+ 40%

Respiratory rate (Lower alarm limit)

- 40%

End Expiratory Pressure (Upper alarm limit)

Mean End Expiratory Pressure + 5 cmH₂O

End Expiratory Pressure (Lower alarm limit)

Mean End Expiratory Pressure - 3 cmH₂O

End-tidal CO₂ Concentration

Upper alarm limit: +25 %

Lower alarm limit: -25 %

12.9.3 ALARMS MISCELLANEOUS

Audio Pause (Alarm silence/reset)

Two-minute silence and reset of latched alarms.

12.10 FUNCTIONS IN VENTILATION MODES

Maximum inspiration time

- Adult: 2.5 s
- Infant: 1.5 s

NIV disconnect function

Adult

- Low flow: 7.5 l/min
- High flow: 40 l/min
- Disabled: The ventilator will continue to deliver assist even when leakage is excessive.

Infant

- Low flow: 7.5 l/min
- High flow: 15 l/min
- Disabled: The ventilator will continue to deliver assist even when leakage is excessive.

12.11 TREND FUNCTION

Peak Airway Pressure	P _{peak}
Pause Airway Pressure	P _{plat}
Mean Airway Pressure	P _{mean}
Positive End Expiratory Pressure	PEEP
Continuous Positive Airway Pressure	CPAP
Spontaneous breaths per minute	RR _{spont}
Breathing frequency	RR
Spontaneous Exp. Minute Volume	MVe _{sp}
Inspired Minute Volume	MVi
Expired Minute Volume	MVe
Leakage fraction (%)	Leakage
Inspired Tidal Volume	VTi
Expired Tidal Volume	VT _e
End Expiratory Flow	\dot{V}_{ee}
Measured Oxygen Concentration	O ₂
CO ₂ End Tidal Concentration	etCO ₂
CO ₂ Minute Elimination	\dot{V}_{CO_2}
CO ₂ Tidal Elimination	VT _{CO₂}
Dynamic compliance	C _{dyn}
Static Compliance	C _{static}
Inspiratory Resistance	R _i
Expiratory Resistance	R _e
Work of Breathing ventilator	WOB _v
Work of Breathing patient	WOB _p
Elastance	E
P0.1	P0.1
Shallow Breathing Index	SBI
Peak Edi value	Edi _{peak}
Minimum Edi value	Edi _{min}
Switch to backup (b/min)	-
Backup (%/min)	-

12.12 OPEN LUNG TOOL TREND (OPTION)

- EIP
- PEEP
- VT_i
- VT_e
- C dyn i
- VTCO₂ (optional CO₂ Analyzer)

12.13 LOG FUNCTION

Event Log

- Alarms
- Ventilator settings
- Apnea periods
- Immediate functions

It is possible to display up to 1000 recorded events in chronological order.

Service Log

- Technical alarms
- Test results
- Preventive maintenance
- Service report history
- Configuration log

12.14 IMMEDIATE FUNCTIONS

Oxygen Breaths

100% for 1 minute.

Start Breath

Initiation of 1 breath in all modes.

(In SIMV mode initiation of one mandatory breath).

Pause Hold

Inspiratory or expiratory.

12.15 COMMUNICATION/INTERFACE

Serial Ports

RS-232C-isolated. For data communication via the Communication Interface Emulator (CIE).

Information regarding connector wiring and EMC performance is available from MAQUET.

Communication Interface Emulator (CIE)

A protocol for data communication with external devices. The SERVO-i Ventilator System software v7.0 uses CIE Protocol version 004. This protocol is compatible with previous versions although all data may not be available.

Alarm Output Connection (Option)

Isolated 4-pole modular connector for communication of high and medium priority alarms. The alarm output connection option is a non-guaranteed alarm in accordance with IEC60601-1-8.

Switching capability: Max 40 V DC, Max 500 mA, Max 20 W.

Information regarding connector wiring and EMC performance is available from MAQUET.

Data Transfer via Ventilation Record Card

File format is Unicode (big endian). Required software is Microsoft Excel 2000, 2003 or 2010 with Visual Basic for applications and a PC card reader.

12.16 SERVICE

WARNINGS!

- Preventive maintenance must be performed by authorized personnel at least once a year or after every 5000 hours of operation. The Status menu on the user interface shows the current operating time.
- Service, repair and installation must be performed by MAQUET authorized personnel only.
- All technical documentation is available for use by MAQUET-authorized personnel.
- Service mode should only be used without a patient connected to the ventilator.

CAUTION:

Original parts from MAQUET must be used.

Battery module replacement, see page 36 for information.

12.17 SERVO ULTRA NEBULIZER (OPTION)

The Servo Ultra Nebulizer has been discontinued.

The information in this document applies to devices sold with versions 6.1 and earlier of the SERVO-i Ventilator System.

Patient Unit

- Weight, approximate (g): 125
- Dimensions (mm): W60 x L108 x H105

Nebulizer T-Piece Connections

Inlet/outlet:

- 22/15 mm outside/inside diameter
- 22 mm inside diameter, ISO standard

Infant patient tubing, nipple connectors:

- 22/10 mm outside diameter
- 15/10 mm outside diameter

Ultrasonic Generator Frequency (MHz)

2.4

Particle Size, approximate (water, μm)

4.0, mass median diameter (MMD) measured distally in endotracheal tube 8 mm inside diameter.

Output from nebulizer (water)

Minimum water flux:

- 0.1 ml/min at gas flow 0.1l/s
- 0.3 ml/min at gas flow 0.5l/s
- 0.5 ml/min at gas flow 1.0l/s.

Buffer Liquid

Sterile water

Maximum Medication Temperature

55° C (131° F)

Volume, medication cup (Maximum, ml)

10

Noise level (Maximum, dBA)

50, measured at 0.3 m distance

Connection Cable Length (m)

2.0

12.18 AERONEB MICROPUMP NEBULIZER (OPTION)

General

- Standard compliance: EN 13544-1.
- Classification: Class I equipment (According to IEC 60 601-1/EN 60 601-1. Type B.)

12.18.1 AERONEB PRO NEBULIZER

Nebulizer Unit

- Weight, approximate (g): 25
- Dimensions (mm): W50 x L50 x H45

Particle Size, approximate (µm)

1 - 5 mass median aerodynamic diameter (MMAD)

Particle size distribution for Salbutamol (Albuterol).

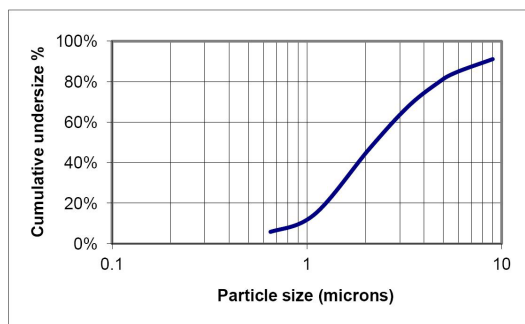

Flow Rate (ml/min)

>0.2 (average: ~0.4)

Internal Volume (ml)

60

Volume, medication cup (Maximum, ml)

10

Residual Volume (%)

10

238

Control Cable length (m)

2.0

Aerosol output rate (ml/min)

0.24 with starting dose 2 ml

Aerosol output (ml)

1.08 with starting dose 2 ml

The temperature of the medication will not rise more than 10°C (18°F) above ambient temperature during normal use.

12.18.2 AERONEB SOLO NEBULIZER

Nebulizer Unit

- Weight, approximate (g): 13.5
- Dimensions (mm): W48 x L25 x H65

Particle Size, approximate (µm)

1 - 5 mass median aerodynamic diameter (MMAD)

Particle size distribution for Salbutamol (Albuterol).

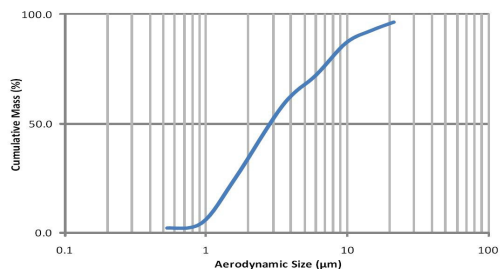

Flow Rate (ml/min)

>0.2 (average: ~0.38)

Volume, medication cup (Maximum, ml)

6

Residual Volume (%)

10

Control Cable length (m)

2.0

Aerosol output rate (ml/min)

0.30 with starting dose 2 ml

Aerosol output (ml)

1.02 with starting dose 2 ml

The temperature of the medication will not rise more than 10°C (18°F) above ambient temperature during normal use.

12.19 CO₂ ANALYZER (OPTION)**12.19.1 GENERAL****Standard compliance**

ISO 80601-2-55

Classification

Class I equipment (According to IEC 60 601-1/EN 60 601-1. Type BF)

Measured parameters

- CO₂ End Tidal Concentration
- CO₂ Minute Elimination
- CO₂ Tidal Elimination

The End Tidal CO₂ Concentration is measured as the maximum CO₂ concentration during the expiration.

Measuring method

Mainstream, dual-wavelength, non-dispersive infrared.

Oxygen concentration compensation

Automatic. Values supplied from the SERVO-i Ventilator System.

Barometric pressure compensation

Automatic. Values supplied from the SERVO-i Ventilator System.

Measurement Conditions

CO₂ minute elimination and CO₂ tidal elimination measurements are referenced to STPD (Standard Temperature Pressure Dry) at 0°C (standard temperature), standard pressure 101.3 kPa and relative humidity 0 % (dry).

Standard gas mixture of CO₂, balance saturated air at 33°C, gas flow rate 2 l/min, halogenated hydrocarbons <5%.

12.19.2 CAPNOSTAT 5 - CO₂ ANALYZER (OPTION)

Size

- CO₂ analyzer module: 154 x 90 x 43 mm
- Sensor: 32.0 x 47.0 x 21.6 mm

Weight

- CO₂ analyzer module: 450 g
- Sensor: 20 g
- Airway adapter: 10 g

Sensor cable

2.8 m

Operating temperature

10°C to 33°C

Measuring range

- 0 to 150 mmHg CO₂ partial pressure
- 0 to 20 kPa CO₂ partial pressure
- 0 to 19.7 % CO₂ volume (at a barometric pressure of 1013 hPa)

Stability (within 8-hour period)

±2 mmHg/±0.3 kPa/±0.3 % (at a barometric pressure of 1013 hPa)

Inaccuracy

The end-tidal CO₂ is calculated as the highest CO₂ reading measured during expiration.²⁶

- ±(3.3 mmHg + 8 % of reading)
- ±(0.44 kPa + 8 % of reading)
- ±(0.43 % of volume fraction + 8 % of reading)

The inaccuracy of the end tidal CO₂ has been verified by a CO₂ reference gas that has been altered with air.

Refer to section Standard condition specification on page 221.

System response time CO₂

The total system response time of the CO₂ monitor when exposed first to air and then to a gas mix with 5.0 % CO₂ is <250 ms.

Warm-up time

15 s to initial CO₂ indication
maximum 2 minutes to full specification

Digitizing rate

100 Hz

Airway adapter dead space

- Neonatal/Pediatric: <1 cm³
- Adult: <5 cm³

12.19.3 CAPNOSTAT 3 - CO₂ ANALYZER (OPTION)

The Capnostat 3 CO₂ analyzer has been discontinued. The information in this document applies to devices sold with versions 7.0 and earlier of the SERVO-i Ventilator System.

Size (mm)

- CO₂ Analyzer module: 154 x 90 x 43
- Sensor: 32.0 x 42.4 x 21.6

Weight (g)

- CO₂ Analyzer module: 450
- Sensor: 18
- Airway adapter: 10

Connectors and Cables

- CO₂ Analyzer module: 15-pole D-sub female connector
- Sensor 20-pole: 2.4 m cable

26. CO₂ accuracy may decrease for RR >40 b/min.

Sensor

Powered from the CO₂ Analyzer module.

Operating temperature range: +10 to + 37°C

Measuring range:

- 0 to 100 mmHg CO₂ partial pressure
- 0 to 13.3 kPa CO₂ partial pressure
- 0 to 13.2% CO₂ volume (at a barometric pressure of 1013 hPa).

Stability (within 8-hour period):

- 0 to 100 mmHg ± 2 mmHg
- 0 to 13.3 kPa ± 0.3 kPa
- 0 to 13.2% ± 0.3% (at a barometric pressure of 1013 hPa).

Inaccuracy

The inaccuracy of the end tidal CO₂ has been verified by a CO₂ reference gas that has been altered with air, see section Standard condition specification on page 221 for test conditions.

- 0 to 40 mmHg ± 2mmHg
- 41 to 70 mmHg ± 5% of reading
- 71 to 100 mmHg ± 8% of reading
- 0 to 5.3 kPa ± 0.3 kPa
- 5.4 to 9.3 kPa ± 5% of reading
- 9.4 to 13.3 kPa ± 8% of reading
- 0 to 5.3% ± 0.3%
- 5.4 to 9.2% ± 5% of reading
- 9.3 to 13.2% ± 8% of reading

System response time CO₂

The total system response time of the CO₂ monitor when exposed first to air and then to a gas mix with 5.0 % CO₂ is <250 ms.

Power source

CO₂ Analyzer module supply voltage: powered from the SERVO-i Ventilator System

Warm-up time

30 s to initial CO₂ indication

maximum 5 minutes to full specification.

Digitizing Rate (Hz)

87

Airway adapter dead space

- Adult <5 cm³
- Infant <1 cm³

12.20 Y SENSOR MEASURING (OPTION)

Size (mm)

- Y Sensor Module: W 154 x L 90 x H 21
- Y Sensor adult Length: 84
- Y Sensor infant Length: 51

Weight (g)

- Y Sensor Module: 400
- Y Sensor adult: 10.5
- Y Sensor infant: 7.5

Sensor Material

Makrolon polycarbonate

Tubing

2.0 m Medical grade PVC

Power Source

Y Sensor Module supply voltage: powered from SERVO-i Ventilator System, < 5 W at 12 V (normal operation)

Y Sensor Measuring Performance

Measuring method: Fixed orifice, differential pressure

Parameters

- Airway pressure
- Airway flow
- Inspiratory Volume
- Expiratory Volume

Measuring Range

- Adult: 2 to 180 l/min
- Infant: 0.125 to 40 l/min

Airway Adapter Dead Space

- Adult: < 9.0 ml
- Infant: < 0.45 ml

12.21 NAVA (OPTION)

General

According to IEC 60 601-1/EN 60 601-1. Type CF.

Size (mm)

Edi Module: L 154 x W 90 x H 21

Cable (m)

2.0 m

Edi Catheter size

- 16 Fr
- 12 Fr
- 8 Fr 125 cm
- 8 Fr 100 cm
- 6 Fr 50 cm
- 6 Fr 49 cm

12.22 ACCESSORIES

12.22.1 MOBILE CART (OPTION)

Weight (kg)

21

Dimensions (mm)

W 560 x L 640 x H 992

12.22.2 DRAWER KIT (OPTION)

Weight (kg)

4.5

Dimensions (mm)

W 300 x L 210 x H 240

12.22.3 HOLDER (OPTION)

For stationary use only.

Weight (kg)

3.5

Dimensions (mm)

W 159 x L 247 x H 352

12.22.4 SHELF BASE (OPTION)

Weight (kg)

1.2

Dimensions (mm)

W 159 x L 205 x H 29

12.22.5 GAS CYLINDER RESTRAINER (OPTION)

Maximum load

Two 5-liter bottles.

12.22.6 IV POLE (OPTION)

Maximum Load (total, kg)

6

12.22.7 GAS TROLLEY (OPTION)

Maximum load

Two 10-kg bottles

12.22.8 COMPRESSOR MINI (OPTION)

Dimensions (mm)

W 430 x D 330 x H 250

Weight (approximate, kg/lbs)

26/70

Power supply

115 V AC, 60 Hz (single phase).

220–240 V AC, 50/60 Hz (single phase).

Compressor capacity

Continuous flow at normal atmospheric pressure (approximately 1013 hPa) 30 l/min (expanded to ambient air pressure) at 3.5 kPa x 100 (bar)/50 psi.

12.22.9 SERVO DUO GUARD

For further information, see the Servo Duo Guard User's Manual.

12.22.10 SERVO GUARD

For further information, see the Servo Guard User's Manual.

12.23 HEALTH AND ENVIRONMENT

12.23.1 POLLUTION CONTROL

This product complies with environmental protection use period as defined in People's Republic of China Electronic Industry Standard SJ/T11364-2006.



Toxic or hazardous substances will not leak or mutate under normal operating conditions for 50 years.

12.23.2 HAZARDOUS SUBSTANCES

The following table shows the names and contents of toxic or hazardous substances in this product as defined in People's Republic of China Electronic Industry Standard SJ/T11364-2006.

Parts	Hazardous substances					
	Pb	Hg	Cd	Cr ⁶⁺	PBB	PBDE
Metal parts	0	0	0	X	0	0
Plastic and polymeric parts	0	0	0	0	0	0
Electrical components	X	0	0	0	0	0
LCD display	0	0	0	0	0	0

0: Indicates that this toxic or hazardous substance contained in all of the homogeneous materials for this part is below the limit and meets the requirement in SJ/T11363-2006.

X: Indicates that this toxic or hazardous substance contained in at least one of the homogeneous materials used for this part is above the limit requirement in SJ/T11363-2006.

For parts and accessories containing phthalates, please refer to the separate addendum, part nr. 66 91 645.

12.24 INFORMATION REQUIRED BY ISO 80601-2-12

12.24.1 VOLUME-CONTROLLED BREATH TYPE

Characteristics valid for patient categories and circuit configurations intended to provide the indicated tidal volume, at conditions specified in ISO 80601-2-12, table 201.103.

Maximum inaccuracy of inspired tidal volume (V_T)

Air/O₂

- $\pm(4 \text{ ml} + 7 \% \text{ of set volume})$ for $V_T \geq 300 \text{ ml}$
- $\pm(4 \text{ ml} + 7 \% \text{ of set volume})$ for $50 \text{ ml} \leq V_T \leq 300 \text{ ml}$
- $\pm(2 \text{ ml} + 7 \% \text{ of set volume})$ for $V_T \leq 50 \text{ ml}$

HeO₂/O₂

- $\pm(4 \text{ ml} + 10 \% \text{ of set volume})$ for $V_T \geq 300 \text{ ml}$
- $\pm(4 \text{ ml} + 10 \% \text{ of set volume})$ for $50 \text{ ml} \leq V_T \leq 300 \text{ ml}$
- $\pm(2 \text{ ml} + 11 \% \text{ of set volume})$ for $V_T \leq 50 \text{ ml}$

Maximum inaccuracy of PEEP

- $\pm(1 \text{ cmH}_2\text{O} + 5 \% \text{ of set value})$ for $V_T \geq 300 \text{ ml}$
- $\pm(1 \text{ cmH}_2\text{O} + 5 \% \text{ of set value})$ for $50 \text{ ml} \leq V_T \leq 300 \text{ ml}$
- $\pm(1 \text{ cmH}_2\text{O} + 5 \% \text{ of set value})$ for $20 < V_T \leq 50 \text{ ml}$
- $\pm(1.5 \text{ cmH}_2\text{O} + 5 \% \text{ of set value})$ for $V_T \leq 20 \text{ ml}$

Maximum inaccuracy of inspired oxygen concentration (FiO₂) at the patient connection port

Air/O₂

- $\pm(3 \% + 0 \% \text{ of set value})$ for $V_T \geq 300 \text{ ml}$
- $\pm(3 \% + 0 \% \text{ of set value})$ for $50 \text{ ml} \leq V_T \leq 300 \text{ ml}$
- $\pm(3 \% + 0 \% \text{ of set value})$ for $V_T \leq 50 \text{ ml}$

HeO₂/O₂

- $\pm(3 \% + 0 \% \text{ of set value})$ for $V_T \geq 300 \text{ ml}$
- $\pm(3 \% + 0 \% \text{ of set value})$ for $50 \text{ ml} \leq V_T \leq 300 \text{ ml}$
- $\pm(3 \% + 0 \% \text{ of set value})$ for $V_T \leq 50 \text{ ml}$

12.24.2 PRESSURE-CONTROLLED BREATH TYPE

Characteristics valid for patient categories and circuit configurations intended to provide the indicated tidal volume, at conditions specified in ISO 80601-2-12, table 201.104.

Maximum inaccuracy of airway pressure (P_{AW}) at the end of the inspiratory phase

- $\pm(1 \text{ cmH}_2\text{O} + 5 \% \text{ of set value})$ for $V_T \geq 300 \text{ ml}$
- $\pm(1 \text{ cmH}_2\text{O} + 5 \% \text{ of set value})$ for $50 \text{ ml} \leq V_T \leq 300 \text{ ml}$
- $\pm(1 \text{ cmH}_2\text{O} + 5 \% \text{ of set value})$ for $V_T \leq 50 \text{ ml}$

Maximum inaccuracy of PEEP

- $\pm(1 \text{ cmH}_2\text{O} + 5 \text{ \% of set value})$ for $V_T \geq 300 \text{ ml}$
- $\pm(1 \text{ cmH}_2\text{O} + 5 \text{ \% of set value})$ for $50 \text{ ml} \leq V_T \leq 300 \text{ ml}$
- $\pm(1 \text{ cmH}_2\text{O} + 5 \text{ \% of set value})$ for $V_T \leq 50 \text{ ml}$

Maximum inaccuracy of inspired oxygen concentration (FiO_2) at the patient connection port**Air/ O_2**

- $\pm(3 \text{ \%} + 0 \text{ \% of set value})$ for $V_T \geq 300 \text{ ml}$
- $\pm(3 \text{ \%} + 0 \text{ \% of set value})$ for $50 \text{ ml} \leq V_T \leq 300 \text{ ml}$
- $\pm(3 \text{ \%} + 0 \text{ \% of set value})$ for $V_T \leq 50 \text{ ml}$

He O_2 / O_2

- $\pm(3 \text{ \%} + 0 \text{ \% of set value})$ for $V_T \geq 300 \text{ ml}$
- $\pm(3 \text{ \%} + 0 \text{ \% of set value})$ for $50 \text{ ml} \leq V_T \leq 300 \text{ ml}$
- $\pm(3 \text{ \%} + 0 \text{ \% of set value})$ for $V_T \leq 50 \text{ ml}$

12.24.3 O₂ CONCENTRATION RESPONSE TIME

Characteristics valid at conditions specified in ISO 80601-2-12, table 201.105.

Response time for oxygen concentration to change from 21 % to 90 %

- Maximum 25 s at $V_T = 500 \text{ ml}$, for patient categories and circuit configurations intended to provide $V_T \geq 300 \text{ ml}$
- Maximum 35 s at $V_T = 150 \text{ ml}$, for patient categories and circuit configurations intended to provide $50 \text{ ml} \leq V_T \leq 300 \text{ ml}$
- Maximum 95 s at $V_T = 30 \text{ ml}$, for patient categories and circuit configurations intended to provide $V_T \leq 50 \text{ ml}$

12.25 UDI LABEL

UDI Label

Unique Device Identification number	Global standard for identifying Medical Equipment, example: (01)07325710000007(11)140625(21)01311141
Application Identifier (AI)	Each UDI number can be divided into several parts, each referred to by their AI number '#).
(01)	GTIN - Global Trade Item Number
(241)	Part number
(10)	Batch no.
(11)	Manufacturing date (YYMMDD)
(17)	Exp. date (YYMMDD)
(20)	Revision
(21)	Serial number
(30)	Count of items

The GTIN consists of four parts:

- a. Package level
- b. GS-1 company prefix
- c. Item reference
- d. Check digit

0 732571 000021 2
 ↓ ↓ ↓ ↓
 a b c d

13 DEFINITIONS

b/min—Breaths per minute

Bias flow—The continuous flow during the expiratory phase

Breath cycle time—Total cycle time per mandatory breath in SIMV (inspiratory + pause + expiratory). Set in seconds.

BTPS — Body Temperature and Pressure Saturated. All measured, preset and indicated flows and volumes at +37°C, local atmospheric pressure and relative humidity 100 % (saturated).

Cdyn—Dynamic characteristics

CMV—Controlled Mechanical Ventilation

CPAP—Continuous Positive Airway Pressure

Cstatic—Static compliance, respiratory system

E—Elastance

Edi—Electrical activity of the diaphragm

Edi Catheter—A single-use feeding tube with measuring electrodes.

Edi Trigger—The predefined level that the Edi signal has to reach to start a new inspiration.

etCO₂—End tidal carbon dioxide concentration

Expiratory hold—Manual closure of inspiration and expiration valves after expiration (max. 30 seconds). Measures Total PEEP.

Flow trigger level—The flow that the patient must inhale to trigger the ventilator to deliver a breath (fraction of the bias flow).

HME—Heat and moisture exchanger

I:E—Inspiration to Expiration ratio (only during controlled ventilation)

IED—The distance between the Edi Catheter electrodes

Inspiratory hold—Manual closure of inspiration and expiration valves after inspiration (max. 30 seconds). Measures plateau pressure.

Inspiratory cycle-off—Fraction of maximum flow at which inspiration should switch to expiration (%)

Inspiratory rise time—Time to full inspiratory flow or pressure at the start of each breath, as a percentage or in seconds of the breath cycle time (% or s)

Leakage — leakage in relation to inspiratory flow (%)

Minute Volume—Volume per minute or target volume (l)

MVe—expiratory Minute Volume

MVe sp—Spontaneous expiratory minute volume

MVe sp / MVe—The ratio of spontaneous expired minute volume to total expired minute volume (only applicable in Bi-Vent/APRV)

MVi—inspiratory Minute Volume

NAVA—Neurally Adjusted Ventilatory Assist.

NAVA level—The relation between measured Edi signal and pressure assist provided.

NAVA ventilation—Ventilation with NAVA or NIV NAVA.

NIV—Non Invasive Ventilation

NIV NAVA — Non Invasive Ventilation Neurally Adjusted Ventilatory Assist

NVT—Neuro Ventilatory Tool.

O₂—Oxygen concentration in vol. %

O₂ breaths—100% oxygen for one minute.

Option—Optional, add-on functionality or accessory

P—Pressure

P0.1—Indicator for respiratory drive

Pause time—Time for no flow or pressure delivery (%)

PC—Pressure Control

PEEP—Positive end expiratory pressure (cmH₂O)

PEEP_{tot}— Set PEEP + Intrinsic PEEP

Paw—Airway pressure

Ppeak—Maximum inspiratory pressure

Phigh—High pressure level

Pmean—Mean airway pressure

Pplat—Pressure during end-inspiratory pause

Pressure trigger level — The negative pressure that the patient has to create to trigger the ventilator to deliver a breath.

PRVC—Pressure-regulated volume control

PS—Pressure support

PS above Phigh—Inspiratory pressure support level for breaths triggered during the Thigh period in Bi-Vent/APRV (cmH₂O)

PS above PEEP—Inspiratory pressure support level for breaths triggered during the TPEEP period in Bi-Vent/APRV (cmH₂O)

Re—expiratory resistance

RH—Relative humidity

Respiratory Rate—Rate of controlled mandatory breaths or used for calculating target volume (b/min)

Ri—inspiratory resistance

RR—Respiratory rate

Service card—Field service software card

SIMV—Synchronized Intermittent Mandatory Ventilation

SIMV rate—Rate of controlled mandatory breaths (b/min)

Start breath—Manually triggered set breath

STPD — Standard Temperature and Pressure Dry. All measured, inlet gas pressures and flows at +20 °C (standard temperature), standard pressure 101.3 kPa and relative humidity 0 % (dry).

T—Time

Tc—Time constant

Ti—Inspiration time

Ti/Ttot—Duty cycle or ratio of inspiration time to total breathing cycle time (only during spontaneous breathing)

Tidal Volume—Volume per breath or target volume (ml)

Thigh—Time at P_{high} level in Bi-Vent/APRV (s)

TPEEP—Time at PEEP level in Bi-Vent/APRV (s)

\dot{V} —Flow

$\dot{V}CO_2$ —CO₂ Minute elimination

\dot{V}_{ee} —End expiratory flow

\dot{V}_{leak} —Leakage flow (l/min)

Ventilation record card—Documentation card

VT_{CO₂}—CO₂ tidal elimination

V_a—Alveolar ventilation

VC—Volume Control

VD_{aw}—Airway dead space

VS—Volume Support

VTA—Alveolar Tidal Volume

VTe—Expiratory Tidal Volume



VTi—Inspiratory Tidal Volume

14 APPENDIX • USER INTERFACE

TABLE OF CONTENTS

14.1	Fixed keys	254
14.2	Special function keys	255
14.3	Quick access key	256
14.4	Main screen key	258
14.5	Menu Key	259
14.6	Biomed menu (Standby)	261
14.7	Screen touchpads	263

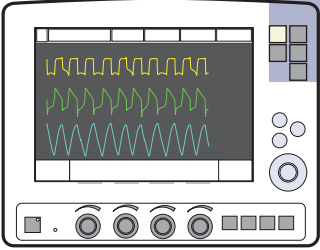
14.1 FIXED KEYS

		
	Audio pause (Silence or pre-silence alarms)	
Alarm profile	Alarm profile setup. Possible selections: <ul style="list-style-type: none"> ■ Pressure (upper) ■ Minute volume (lower and upper) ■ Respiratory rate (lower and upper) ■ End expiratory pressure (lower and upper) ■ Alarm sound level (10-100%) ■ End tidal CO₂ (lower and upper) <div style="background-color: #f0f0f0; padding: 5px; margin-top: 10px;"> Note: In NIV the alarm sound can be permanently silenced (audio off). </div>	By pressing <i>Autoset</i> in controlled modes of ventilation the alarm limits are automatically set for: <ul style="list-style-type: none"> ■ Pressure ■ Volume ■ Resp. Rate ■ PEEP ■ CO₂ <div style="background-color: #f0f0f0; padding: 5px; margin-top: 10px;"> Note: Autoset is not possible in NIV. </div> In spontaneous modes an alarm setting for apnea time is available.
Save	The Save key can be used to either: <ul style="list-style-type: none"> ■ copy screen, or ■ save one recording (10 s before and 10 s after pressing the key) 	
Trends	The trend graph appears when the <i>Trend</i> key is pressed. Data can be recorded over a period of time up to 24 hours. The time resolution is displayed in the trend graph.	
	Function is not implemented.	
Neural access	The <i>Neural access</i> key opens a menu with the following choices: <ul style="list-style-type: none"> ■ Edi Catheter positioning ■ NAVA preview ■ Neuro Vent. Tool ■ NVT scales 	

14.2 SPECIAL FUNCTION KEYS

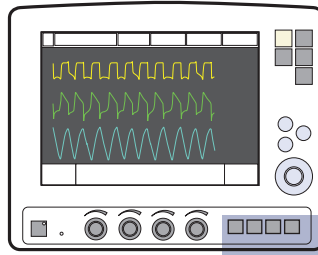

Start breaths	The ventilator will initiate a new breath cycle according to the current ventilator settings.
O₂ breaths	<p>This function allows 100% oxygen to be given for 1 minute. After this time the oxygen concentration will return to the pre-set value. The oxygen breaths can be interrupted by pressing the <i>O₂ breaths</i> fixed key during the 1 minute interval.</p> <p>Note: If <i>O₂ breaths</i> is activated during the pre- or post-oxygenation phase in Suction Support the procedure will be discontinued.</p>
Exp. hold	<p>Expiratory hold is activated by manually pressing the <i>Exp. hold</i> key. The maximum time is 30 seconds. The inspiratory and expiratory valves close after expiration. This function can provide an exact measurement of the end expiratory lung pressure. It can be used for static compliance measurement and to determine the total PEEP.</p> <p>Note: Expiratory hold is not available in Nasal CPAP.</p>
Insp. hold	<p>Inspiratory hold is activated by pressing the <i>Insp. hold</i> key. The maximum time is 30 seconds. The inspiratory and expiratory valves close after expiration. This function can provide an exact measurement of the end inspiratory lung pressure. It can be used during x-ray or to determine Plateau pressure, or static compliance calculation.</p> <p>Note: Inspiratory hold is not available in Nasal CPAP.</p>

14.3 QUICK ACCESS KEY

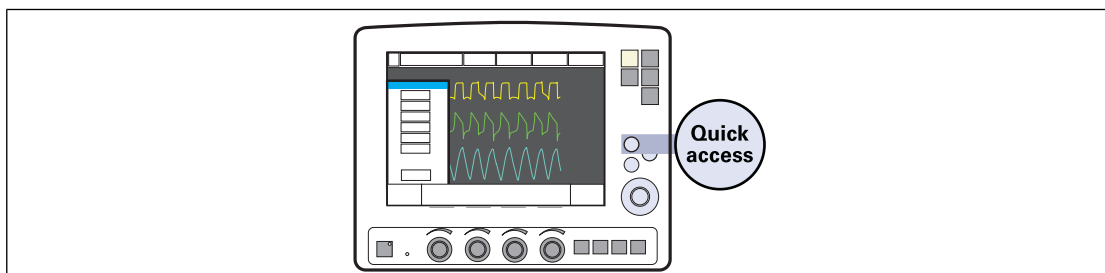



<p>Suction Support</p>	<p>This function allows the user to disconnect the patient from the ventilator and turns off the alarms (for apnea, minute volume, frequency alarm, check tubing, low PEEP) during suction support.</p> <p>Note: Suction support is not available when NIV or O₂ breaths are activated.</p>
<p>Loops</p>	<p>Loops are graphs that show two measured values: one measured value (x-axis) against another measured value (y-axis). Loops are updated breath by breath.</p> <p>Two loops are available:</p> <ul style="list-style-type: none"> ■ volume-pressure ■ flow-volume <p>Note: A reference loop can be saved by the user.</p>
<p>Waveform scales</p>	<p>Waveform scaling</p> <ul style="list-style-type: none"> ■ Pressure scaling ■ Flow scale ■ Volume scale ■ CO₂ scale ■ Edi scale <p>These scales are set to automatic scaling, by default. The sweep speed (mm/s) can be set to 5, 10 or 20 mm/s (default).</p>

Waveform configuration	Possibility to increase the space for viewing the waveform curves. This means that more detailed information can be viewed.
Open Lung Tool Open Lung Tool Scales	<p>The Open Lung Tool assists in alveolar recruitment procedures. The screen gives information about End inspiratory pressure (EIP) and PEEP, inspiratory and expiratory Tidal Volume as well as Dynamic Compliance (Cdyn i).</p> <p>Note: Open Lung Tool is not available in NIV.</p>
Stress Index	<p>The Stress Index is displayed on the ventilator in the following ways:</p> <ul style="list-style-type: none"> ■ Numerically, as a value in the value list. ■ Numerically and graphically in the Stress Index window. ■ Graphed over time, i.e. a trend.

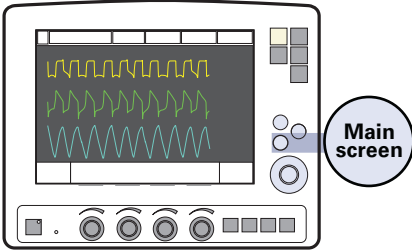
14.4 MAIN SCREEN KEY

	
<p>Main screen</p>	<p>The <i>Main screen</i> fixed key will return you to the Main screen, cancelling current work, from wherever you are in the Menu/dialog windows.</p>

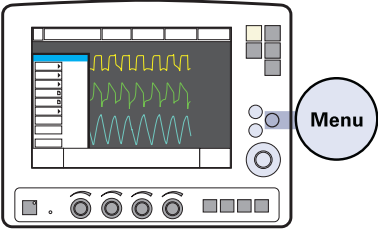
14.5 MENU KEY

		
Alarm	Alarm profile setup	
<i>Alarm:Profile</i>	<p>Alarm profile setup. Possible selections:</p> <ul style="list-style-type: none"> ■ Pressure (upper) ■ Minute volume (lower and upper) ■ Respiratory rate (lower and upper) ■ End expiratory pressure (lower and upper) ■ Alarm sound level (10-100%) ■ End tidal CO₂ (lower and upper) <p>Note: In NIV the alarm sound can be permanently silenced (audio off).</p>	<p>By pressing <i>Autoset</i> in controlled modes of ventilation the alarm limits are automatically set for:</p> <ul style="list-style-type: none"> ■ Pressure ■ Volume ■ Resp. Rate ■ PEEP ■ CO₂ <p>Note: Autoset is not possible in NIV.</p> <p>In spontaneous modes an alarm setting for apnea time is available.</p>
<i>Alarm:History</i>	This shows alarms that have been activated. The list is in alphabetical order.	
<i>Alarm:</i> 	Audio pause (Silence or pre-silence alarms)	
Review		
<i>Review:Trends</i> <i>Review:Recorded waveforms</i> <i>Review:Event log</i> <i>Review:View configuration</i>	Review trends, recorded waveforms, event log or configuration.	

Options	
Options:CO ₂ calibration Options:Edi module test	CO ₂ calibration, Edi Module test
Compensate	Under " <i>Compliance</i> " it is possible to activate or deactivate circuit compliance compensation. Under " <i>Gas type</i> " it is possible to compensate the system for HeO ₂ /Air.
Copy	
Copy:Copy data	Copy data (event log, recordings, trends, OLT data, Start-up configuration) to PC Card.
Copy:Copy screen	Copy screen to PC Card.
Biomed	
Biomed (Standby)	
Biomed:O ₂ cell adaptation (only during ventilation)	Measured O ₂ concentration will be adapted in relation to set value.
Panel lock	Locks all user input functions on the User Interface. Press <i>Main screen</i> fixed key to unlock.
Change patient category (only during ventilation)	Available in SERVO-i Ventilator System, Universal only. Switches between Adult and Infant patient category.

14.6 BIOMED MENU (STANDBY)

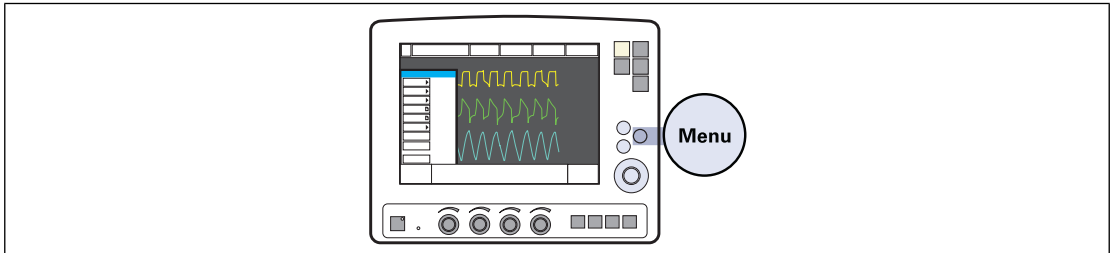

Biomed	
	Enter code 1973 to access Biomed menus. The access code can be changed by the user.
Service:Event log <i>Alarms</i> <i>Ventilator settings</i> <i>Functions</i>	Display Event logs. Possible selections: ■ latest logs ■ selected time interval
Service:Service log <i>Technical alarms</i> <i>Test results</i> <i>Preventive maintenance</i> <i>Service report history</i> <i>Installation log</i>	Display service logs. Possible selections: ■ 21 latest logs ■ selected time interval
Service:Report PM	Enters a date for the preventative maintenance into the service log.
Service:Replaced Exp membrane	Reset of breath counter in expiratory cassette.

<p>Edit configuration</p> <ul style="list-style-type: none"> <i>Alarm sound level</i> <i>Adult alarm limits</i> <i>Infant alarm limits</i> <i>Displayed values</i> <i>NIV adult alarm</i> <i>NIV infant alarm</i> <i>Startup configuration</i> 	<p>User default configuration setup.</p>
<p>Copy configuration</p>	<p>Copy configuration to/from PC card.</p>
<p>Set date and clock</p>	<p>Date and time setup.</p>
<p>Change access code</p>	<p>Change access code to Biomed menu.</p>
<p>Start MCare Remote Service</p>	<p>Starts MCare Remote Service function</p>

14.7 SCREEN TOUCHPADS

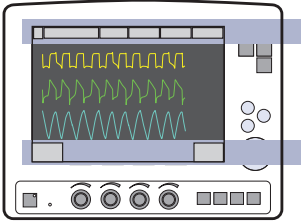
							
Mode Xxxx	<p>When the soft key for a selected ventilation mode is pressed, a window appears with the valid settings for this mode. The window has an <i>Accept</i> soft key and a <i>Cancel</i> soft key. When the <i>Accept</i> soft key is pressed the ventilator starts to ventilate with the new settings. If the <i>Cancel</i> soft key is pressed this window will disappear and the ventilator will continue to ventilate with the original settings. To support the clinician in adjusting settings some values, derived from settings, are shown in the upper right field of the set ventilation mode window e.g. inspiration time in seconds, calculated inspiratory flow.</p>						
Automode	<p>The touchpad <i>Automode</i> selects the Automode function. When the patient is breathing spontaneously:</p> <ul style="list-style-type: none"> ■ The green indicator is lit ■ The ventilation mode text goes from grey to black. 						
Admit patient	<p>When the admit patient function is activated the clinician can enter or amend patient details:</p> <table style="width: 100%; border: none;"> <tr> <td style="width: 50%;">■ patient name</td> <td style="width: 50%;">■ date of admission</td> </tr> <tr> <td>■ identity number</td> <td>■ height</td> </tr> <tr> <td>■ date of birth</td> <td>■ weight</td> </tr> </table>	■ patient name	■ date of admission	■ identity number	■ height	■ date of birth	■ weight
■ patient name	■ date of admission						
■ identity number	■ height						
■ date of birth	■ weight						
Nebulizer	<p>The Nebulizer function turns the nebulizer on or off. It is possible to set the duration of nebulization between 5 and 30 minutes. The default time is 10 minutes.</p> <p>During nebulization the remaining time is displayed in the nebulizer touchpad.</p> <p>The Servo Ultra Nebulizer is automatically disabled during battery operation.</p>						

<p>Status</p> <ul style="list-style-type: none"> General O₂ cell/sensor Exp. cassette Batteries Modules Installed options Pre-use check 	<p>In the Status function, an icon displays which power source is currently active i.e. Mains, Ext. 12 V, or battery. When one or more batteries are in use, information about remaining time is also displayed. When the <i>Status</i> touchpad is activated a windows appears displaying the status of:</p> <ul style="list-style-type: none"> ■ General system information ■ Status of O₂ cell/sensor ■ Status of Expiratory cassette ■ Status of batteries ■ Status of CO₂ module (if used) ■ Status of Y Sensor module (if used) ■ Installed options ■ Status of Pre-use check
<p>Additional settings</p>	
<p><i>I:E/Insp. times</i></p>	<p>Press the <i>Additional settings</i> touchpad to see the settings available for the current mode.</p> <p>Vital parameters are set using the Direct Access Knobs.</p> <p>The bar below the numeric value is a graphical representation of the chosen value and gives information about the parameter ranges.</p> <ul style="list-style-type: none"> ■ the bar is white if your setting is within what is generally considered safe ranges ■ the bar turns yellow if your setting is slightly beyond what is generally considered safe ranges ■ the bar turns red if your setting is significantly beyond what is generally considered safe ranges
<p><i>Trigger</i></p>	<p>The trigger sensitivity bar is colored based on the setting:</p> <ul style="list-style-type: none"> ■ the bar is green for a normal setting for flow triggering ■ the bar is red when there is a risk of self-triggering ■ the bar is white when pressure triggering is selected. <p>Note: If there is leakage in the breathing system, e.g. if an uncuffed endotracheal tube is used, triggering will then be initiated by the system and not by the patient. This should always be avoided by decreasing the trigger sensitivity.</p>
<p><i>Backup ventilation</i></p>	<p>This touchpad will be visible in supported ventilation modes.</p>
<p>Additional values</p>	<p>This is an area of the screen which shows which shows measured/calculated numerical values.</p> <p>Values will be presented on two pages (three pages if Lung Mechanics option is installed). By pressing Additional values it is possible to scroll between the pages.</p> <p>Note: In NIV, only one page is available.</p>

15 CERTIFICATES

TABLE OF CONTENTS

15.1 China	266
------------	-----

15.1 CHINA

15.1.1 SERVO-i

CFDA registration no	CFDA(I)20133544784
Product standard no	YZB/SWE 6275-2013
Manufacturing date	For manufacturing date, see label on the device
Manufacturer	Maquet Critical Care AB
Manufacturer/Manufacturer site address	Rontgenvagen 2, SE-17154 Solna, Sweden
Agent for registration and after sales	Maquet (Shanghai) Medical Equipment Co., Ltd.
Agent address	Room 227, 2nd floor, No. 56, Meisheng Road, Pilot Free Trade Zone, Shanghai, China
Agent contacts	800 820 0207
IFU revise date	141118

16 INDEX

- A**
- Abbreviations
 - 249
 - see Definitions
 - Accessories 181
 - Activity instruction 37
 - Additional settings 57, 264
 - Additional values 64, 264
 - Adult alarm limit 262
 - Adult range
 - Air/O₂ 225–226
 - HeO₂/O₂ 226
 - AGA adapter 145
 - Alarm output connection 173, 236
 - Alarm output connection option, test 46
 - Alarm profile
 - 42
 - see Set alarm limits
 - Alarms
 - Alarm (technical data) 231
 - Alarm limit 55, 180, 254
 - Audio off 21
 - Autoset 233
 - High priority alarms 176, 203
 - History 259
 - Low priority alarms 175–176
 - Medium priority alarms 173, 175, 207
 - Pre-silencing alarms 176
 - Alarm settings 231
 - Alarm sound level 55, 254, 259, 262
 - Appendix
 - Fixed keys 254
 - Main screen key 258
 - Menu key 259
 - Quick access key 256
 - Screen touch pads 263
 - Special function keys 255
 - Audio pause 175–176, 233
 - Automatic gas identification 147
 - Automode 105
- B**
- Backup ventilation 127
 - Battery
 - Charge indicator 37
 - Module 36
 - Battery status 36
 - Battery status window 37
 - Before use 10, 152
 - Biomed 261
 - Bi-Vent 118
 - Breath cycle time 84
 - Brief device description 6
 - BTPS 221, 249
- C**
- Cautions 9
 - Change access code 262
 - Cleaning and Maintenance 7
 - CO₂ Analyzer 193, 239
 - CO₂ Analyzer
 - Calibration 195
 - Components 194
 - Use guidelines 194
 - Communication/Interface 235
 - Compressor Mini 244
 - Connections and labels 19, 28
 - Continuous nebulization 192
 - Copy
 - Patient data 73–74
 - Copy configuration 214, 261–262
- D**
- Default values 230, 233
 - Definitions 249
 - Dimensions
 - Compressor Mini 244
 - Drawer kit 243
 - Holder 243
 - Mobile Cart 243

- Shelf base 243
- Direct access knob 24
- Displayed values 262
- Disposable parts 152
- DISS adapters 146
- Drawer kit 243

E

- Edi Catheter 159–161
- Edi Catheter
 - Before inserting 159
 - Inserting 160
 - Positioning 161
 - Symbols 33
- Edi module 158
- Edi module
 - Function check 158
 - Insert into patient unit 158
- Edit configuration 215, 262
- EMC 218
- Event log 70
- Expiratory cassette 27, 32
- Expiratory channel 224
- Expiratory hold 249
- External 12 V 36, 219
- External patient monitoring 144

F

- Face mask 121
- Fisher & Paykel
 - Humidifier 182
- Fixed keys 24
- Flow trigger level 249
- French adapter 145

G

- Gas cylinder restrainer 243
- Gas flow 31–32
- Gas mismatch 147
- Gas supply 220
- Gas Trolley 244

H

- Heliox
 - Changing gas type 146
 - HeO₂ connection 145
- Heliox adapters 143
- Helmet 144, 199–200
- HeO₂ icon 147
- High priority alarms 203
- History 259
- Holders
 - Gas cylinder restrainer 243
 - IV Pole 244
 - Shelf base 243
- Humidifier
 - Fischer & Paykel 182
 - Teleflex Medical 182

I

- I:E ratio 131
- I:E ratio/inspiration time 82
- Important 9
- Infant alarm limits 262
- Infant range
 - Air/O₂ 225–226
 - HeO₂/O₂ 226
- Informative text message 20
- Inspiration time 131
- Inspiratory channel 32, 223
- Inspiratory cycle-off 83
- Inspiratory hold 136
- Inspiratory rise time 81
- Intended use 6
- Intended user 6
- Internal tests 44
- Invasive ventilation 56

L

- Loops 69
- Low priority alarms 211

M

- Main rotary dial 23

Main screen key 258
 Mandatory breath 109–110
 Measured value boxes 64
 Measured values 64
 Medium priority alarms 207
 Menu key 26
 Minute volume 53
 Mobile cart 34, 243

N

Nasal CPAP 125
 Nasal mask 121
 NAVA 151
 NAVA
 Components 153
 Functional description 154
 General 152
 Overview 153
 Set NAVA level 165
 Workflow 157
 Neuro ventilatory tool 170
 NIST adapter 145
 NIV 121
 NIV
 Adult alarm 262
 Infant alarm 262
 Nasal CPAP 125
 Pressure control 123
 Pressure support 124
 Non Invasive Ventilation 121
 Non-operating conditions 218

O

O₂ breaths 135
 O₂ cell 32, 60
 O₂ sensor 32, 60
 Operating conditions 218
 Options/Accessories 181

P

Panel lock 260
 Patient breathing system 32, 45

Patient category 51
 Patient circuit test 50
 Patient data 52
 Patient range 199
 Patient unit
 Connections and labels 28
 Gas flow 30, 32
 Pause time (T pause) 131
 PEEP 82
 Power supply 12
 Pressure Control 91
 Pressure Control
 Controlled ventilation 91
 Pressure control + Pressure support 114
 Pre-use check 42
 Pre-use check tests 42
 Previous mode 85
 PRVC 94
 PRVC
 Controlled ventilation 94

Q

Quick access key
 Loops 256
 Scales 138

R

Remote Service 216
 Respiration cycle 155
 Respiratory rate 85
 Review 259

S

Service 7
 Service Log 7
 Servo Duo Guard 244
 Servo Guard 244
 SERVO-i
 Adult 14
 Infant 14
 Universal 14
 Set alarm limits 55

Set up and start ventilation

NAVA 166

NIV NAVA 169

Shelf base 243

Software version 10

Special functions

Fixed keys 134

Spontaneous breathing/CPAP 104

Standards 218

Standby 123, 259

Start breath 134

Start-up configuration 213

Status 27

STPD 221, 250

Stress Index 140

Suction support 58

Support arm 10

Symbols

Patient unit 28

User interface 19

T

Technical error messages 212

The system

Technical data 217

Tidal volume 251

Touch screen 22

Trends 70

Trigg. Flow 80

Trigger

Indication 21

Trigger sensitivity 80

Trigg Pressure 80

Troubleshooting

Medium priority alarms 207

Technical errors 202

Type of ventilation 53

U

User Interface

Connections and labels 19

V

Ventilation

Bi-Vent 118

Heliox 143

I:E ratio/inspiration time 82

Mandatory breath 110

Modes of ventilation 78

Parameters 131, 156

Pressure Control 91

PRVC 94

Set ventilation mode 54

Supported ventilation 97, 100

Volume Control 86

Ventilation record card

Copy patient data 74

Copy screen data 73

Ventilator 18

Ventilatory 77

Volume Control 86

Volume Control

Controlled ventilation 86

Volume Control with alternative flow patterns

89

W

Warnings 9

Water trap 182

Waveform 66, 71

Waveform configuration 257

Waveform scales 68, 256

Weight 220

Workflow 42

Y

Y sensor 197

MAQUET

GETINGE GROUP

Maquet Critical Care AB
Röntgenvägen 2
SE-171 54 Solna, Sweden
Phone: +46 (0) 8 730 73 00
www.maquet.com

For local contact:
Please visit our website
www.maquet.com



0123

GETINGE GROUP is a leading global provider of products and systems that contribute to quality enhancement and cost efficiency within healthcare and life sciences. We operate under the three brands of ArjoHuntleigh, GETINGE and MAQUET. ArjoHuntleigh focuses on patient mobility and wound management solutions. GETINGE provides solutions for infection control within healthcare and contamination prevention within life sciences. MAQUET specializes in solutions, therapies and products for surgical interventions, interventional cardiology and intensive care.

SERVO-i VENTILATOR SYSTEM V7.1

User's Manual