



# Servo-u

## Startup guide

This document is intended to provide information to an international audience outside of the US.



# Contents

Contents .....	3
1 System overview.....	4
2 Alarms.....	19
3 Maneuvers .....	22
4 Trends .....	30
5 NAVA and NIV NAVA .....	32
6 High Flow therapy.....	35
7 Views .....	36
8 Media .....	42
9 Neonatal patient category.....	43
10 Heliox.....	46

## Note

This guide is intended for hospital personnel as start up training using the Servo-u® 4.1 ventilator. It does not cover all aspects of the Servo-u 4.1 ventilator. Please see the user's manual for more information.

Some modes and functions are options and might not be included.

# 1 System overview



Behind the hatch are gas and electrical connections. The ON/OFF switch is placed to the left of the gas inlets. The switch must be pulled down from lock position before it can be used.



The Servo-u modules are interchangeable between the Servo-n® and Servo-i® ventilator models (except the Y sensor modules). The Servo-u can host 2-6 battery modules and several different plug-in modules. An alarm “Missing Battery” will be activated if less than 2 batteries are mounted.



It is important that the expiratory cassette is properly attached (you will hear a ‘click’ sound when it locks into position).



1. Expiratory outlet
2. AC mains power LED, blue
3. Power on LED, green
4. On/Off switch
5. RS-232 connectors
6. Fuse for external DC power
7. External +12V DC inlet
8. User interface control cable connector
9. AC mains power source connector with fuse
10. Potential equalization terminal
11. Alarm output connection
12. Cooling fan with filter
13. Lock for inspiratory channel cover
14. Gas inlet for Air
15. Gas inlet for O<sub>2</sub>

16. Inspiratory channel cover
17. Inspiratory outlet
18. Emergency air intake
19. Module compartment
20. Expiratory inlet
21. Nebulizer connector
22. Module release levers

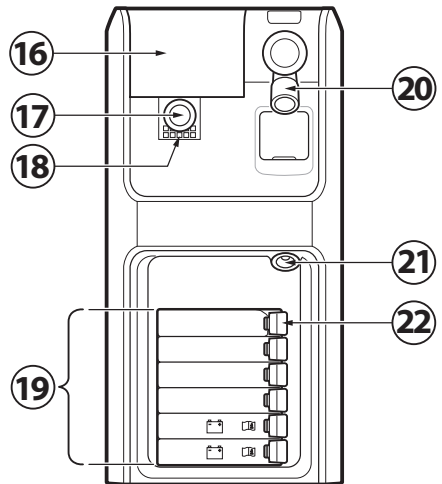
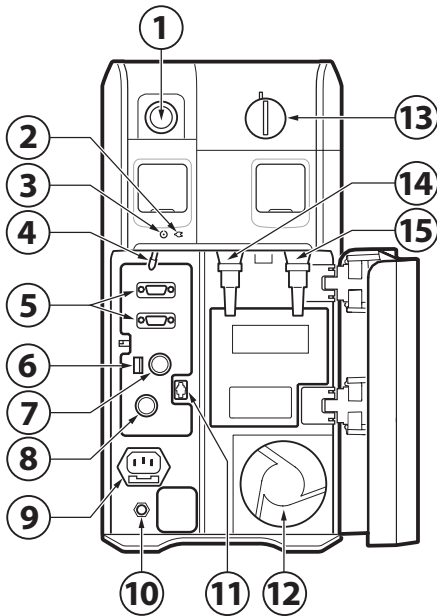

1. Alarm indicator, light frame
2. Ambient light sensor for automatic adjustment of screen brightness
3. Cable reel for the user interface control cable
4. Control cable (2.9 m long)
5. User interface stand
6. Loudspeaker
7. Network cable port
8. User interface control cable port
9. VGA port
10. USB port
11. Serial number label

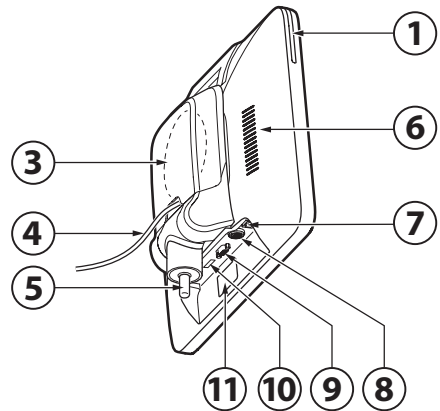
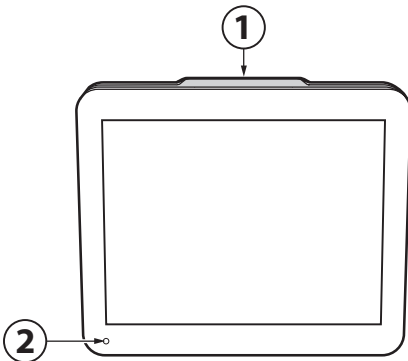

## 1.1 Workflow to start ventilation

1. Turn on the ventilator system, prepare the patient circuit to be used and perform a pre-use check.
2. Select patient category.
3. Select invasive or non invasive ventilation.
4. Set the ventilation mode.
5. Check, and if necessary, adjust the alarm limits.
6. Enter data for the new patient, including height, weight, and gender (optional).
7. Start ventilation and connect ventilator system to patient.
8. Adjust alarm limits if necessary.

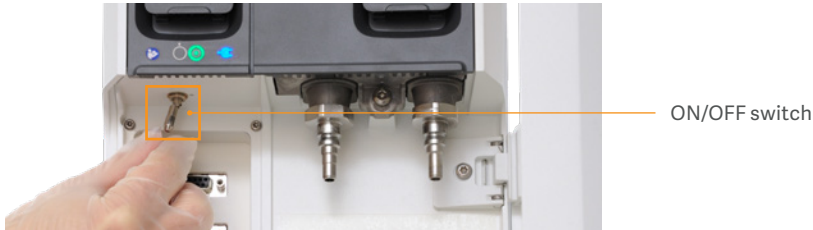

## 1.2 Pre-use check

The pre-use check takes approximately five minutes, is started from Standby view and is semi-automatic.

The patient circuit test measures resistance and compliance in the patient circuit. If the patient circuit is changed and no new patient circuit test is performed, the ventilator will compensate incorrectly with the previous patient circuit. If the correct circuit is not tested, the following risks may arise:

- In volume-based modes, the volume delivered to the patient will be incorrect.
- In pressure-based modes, the volume measured will be incorrect.





The patient circuit test is included in the pre-use check but can also be selected separately.

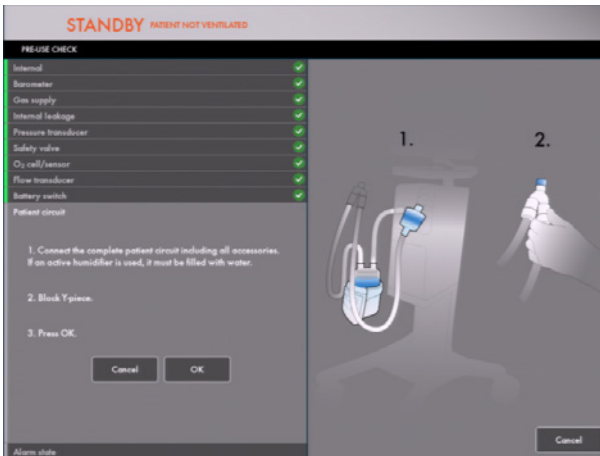

The symbol highlighted below indicates that the circuit compensation is on. If there has not been any circuit compensation there will not be any symbol present.





### 1.3 Modes and settings

There are three different patient categories, adult, pediatric and neonatal. The neonatal patient category is optional on Servo-u and will therefore not be shown if not included.

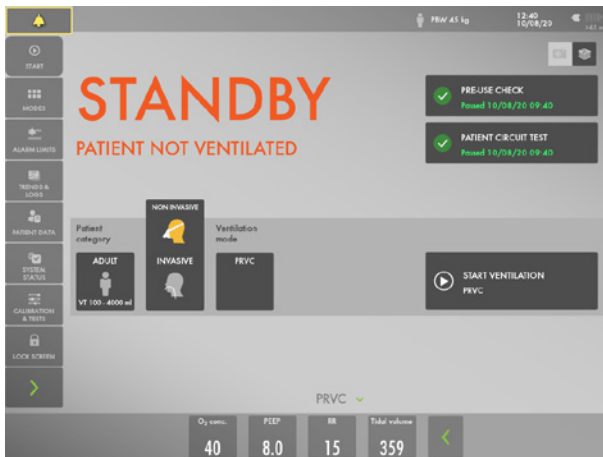

Select non invasive ventilation or invasive ventilation.



Slide the bar to the right or left to increase or decrease the settings.  
Confirm the setting by tapping .  
Exit settings without changing by tapping the .

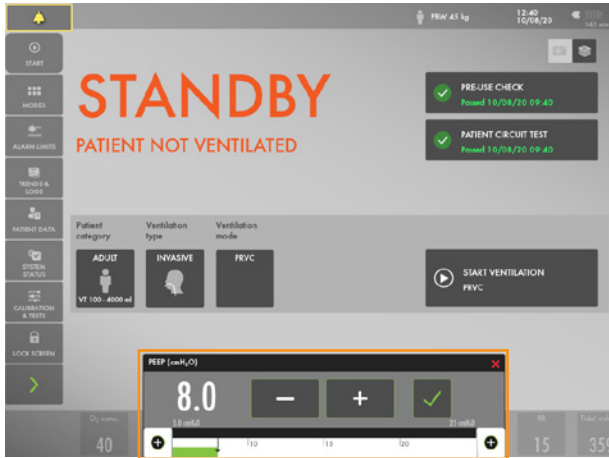

The bar displays the safety scale, which is the range that represents normal use for most patients. To access the full settings range tap the .

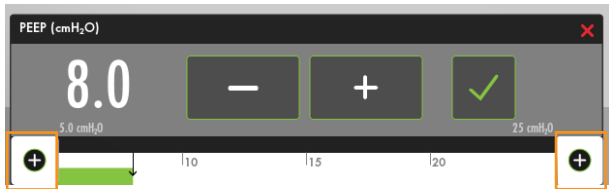

## 1.4 Modes

Tap to select mode. The current mode tile is always highlighted and the previous mode tile is marked PREVIOUS, together with the date and time it was last used.



Non invasive modes: All non invasive modes are optional and may therefore may not be available. Nasal CPAP is available in the pediatric and neonatal patient categories, and NIV PS is available in adult and pediatric patient categories.

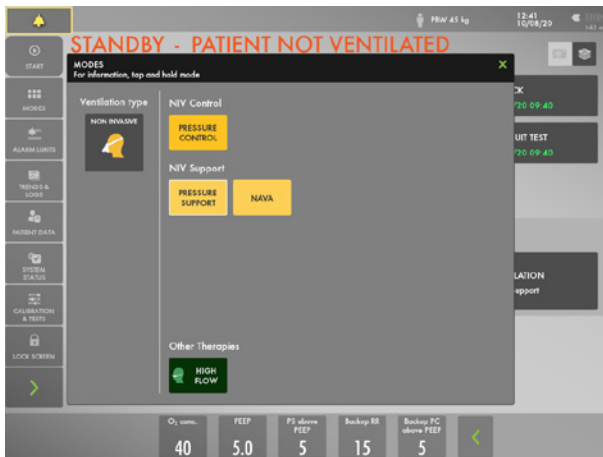

The mode settings are in supported and interactive modes divided into supported and controlled settings.

Supported mode setting

Apnea Time

Controlled mode setting

Help information

## 1.5 Context based guidance

Tap and hold on the mode tile to see more information.

PRVC

MODES

For information, tap and hold mode.

**PRESSURE REGULATED VOLUME CONTROL (PRVC)**

- combines the advantages of Volume Control and Pressure Control by delivering a preset tidal volume with a decelerating inspiratory flow at a preset respiratory rate;
- maintains the lowest possible constant pressure throughout inspiration;
- the inspiratory pressure of a breath will never exceed 5 cmH<sub>2</sub>O below the upper pressure limit.

Typical pressure (yellow) and flow (green) waveforms in PRVC:

- Upper pressure limit
- The pressure may not exceed 5 cmH<sub>2</sub>O below the upper pressure limit

Set mode

Dynamic images are presented for some of the settings. A dynamic image illustrates the effects of changes made.



Press the (i) symbol and additional information will be presented.



## 1.6 Trigger settings

When triggering is based on flow, to the left on the scale, the ventilator system senses deviations in the bias flow delivered during expiration. The further to the left on the scale, the less effort the patient has to make. At the far left of the scale, there is a risk of auto-triggering, and the scale and value are therefore marked in red.

When triggering is based on pressure, to the right on the scale, the ventilator system senses deviations in the pressure below PEEP created by the patient. The pressure below PEEP required to initiate a breath is displayed when the setting is made. The further to the right on the scale, the greater the patient effort required to trigger.



## 1.7 VT/PBW

In adult patient category enter patient gender and height, in pediatric and neonatal categories enter weight. It is important that patient circuit compensation is on to receive accurate VT/PBW.



The ventilator monitors the ratio of tidal volume to predicted body weight (VT/PBW). VT/PBW (ml/kg) is continuously trended and measured. For pediatric/neonatal patient category body weight (BW) is used.

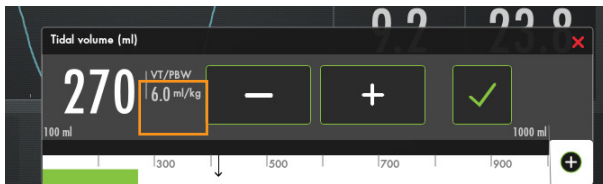



## 1.8 User interface



By pressing < additional values and settings become available.



## 1.9 Active/inactive modes and settings

The grey text and settings indicate an inactive mode and settings. If the mode is changed then the other mode becomes white.



# 2 Alarms

Light frame for 360° visibility. Alarm indication is shown in two ways; blinking value (measured or calculated) and alarm message in the alarm message area.



- High priority
- Medium priority
- Low priority

Settings for alarm limits include upper and lower limits settings and the current measured value.

Autoset alarm limits are available in controlled modes.

The image displays two screenshots of a medical device's user interface, illustrating alarm management features. The top screenshot shows the 'ACTIVE ALARMS' screen with three active alarms: 'Airway pressure high', 'Respiratory rate high', and 'Volume delivery restricted'. The bottom screenshot shows the 'PRVC ALARM LIMITS' screen, where users can set upper and lower limits for parameters like P<sub>peak</sub>, PEEP, RR, and MV<sub>a</sub>. The current measured values are also displayed, along with an alarm sound level setting.

Three alarms active

Alarm management checklist

Upper alarm limit

Current measured value

Lower alarm limit

Alarm sound level setting

With some alarms the audio can be turned off by tapping . Audio off is displayed in the corresponding parameter in the numerical values area and a message is displayed in the status bar.



# 3 Maneuvers

## 3.1 Open lung Tool

Open Lung Tool and Transpulmonary pressure are options and if not included not visible on the screen.

Open Lung Tool can be used to facilitate lung recruitment maneuvers or assess other respiratory interventions.



The following three tools are available:

- Auto SRM – an automatic stepwise recruitment maneuver that includes a decremental PEEP titration
- Auto RM – an automatic recruitment maneuver
- OLT Trends – breath-by-breath trends for measured lung mechanical values.

Auto SRM is an automatic recruitment maneuver that includes an post recruitment personalized PEEP and driving pressure that is based on optimal dynamic compliance. There is an workflow that supports on how to set the recruitment maneuver and it can be stopped at any time if needed.



Auto RM is an automatic recruitment maneuver that doesn't have the PEEP titration and is therefore shorter. The recruitment phases settings are visualized in a graph.





OLT trends is a tool for manual recruitment with breath-by-breath trends for measured lung mechanical values or assess other respiratory interventions. It is possible to use OLT trends and follow the transpulmonary pressures during a lung recruitment maneuver.

### 3.2 Static measurements





### 3.3 Inspiratory hold

Expiratory and inspiratory valves are closed after the inspiratory phase is completed for as long as INSPIRATORY HOLD is pressed. This function can provide an exact measurement of the end inspiratory lung pressure. It can be used to pause ventilation during X-ray or to determine the plateau pressure (Pplat), or, together with the expiratory hold, to calculate static compliance.

### 3.4 Expiratory hold

Expiratory and inspiratory valves are closed after the expiration phase is completed for as long as EXPIRATORY HOLD is pressed. Expiratory hold provides an exact measurement of the end expiratory pause pressure. It can be used to determine total PEEP and, together with inspiratory hold, static compliance (Cstatic)..

### 3.5 Manual breath

When MANUAL BREATH is tapped, the ventilator system will initiate a new breath cycle according to the current ventilator settings.



### 3.6 Nebulization

Nebulization can be either activated for a certain period of time (5–30 minutes) or continuous (only use Aerogen Solo).



### 3.7 O<sub>2</sub> boost

When tapped and hold, O<sub>2</sub> boost delivers the oxygen setting displayed here for a period of 1 minute. The O<sub>2</sub> boost function can be interrupted by tapping the red cancel symbol in the O<sub>2</sub> boost timer window anytime during the 1 minute interval.



By tapping O<sub>2</sub> BOOST LEVEL, it is possible to change the desired level for the O<sub>2</sub> boost function. It is possible to lock the O<sub>2</sub> boost level to 100 %. The value entered under O<sub>2</sub> boost (%) level specifies the number of percentage points that will be added to the value set for the O<sub>2</sub> concentration.



It is also possible to set it to 0 %, in which case the O<sub>2</sub> boost function will no longer be active and will be replaced by three asterisks.

### 3.8 Transpulmonary pressure

On the Servo-u it is possible to measure Transpulmonary pressure (optional). Any Esophageal balloon catheter can be used as long as the pressure connection line can be connected to the Y sensor module.

There is an automatic occlusion maneuver that validates positioning and filling of the catheter. Also there is a therapeutic view including waveforms and numerical values:

End-inspiratory transpulmonary pressure (PL ei), Transpulmonary driving pressure (PL drive), End-expiratory transpulmonary pressure (PL ee) and Esophageal delta pressure ( $\Delta P_{es}$ ).



## 2.10 Disconnection support

DISCONNECTION enables automatic inhibition of the ventilator system during a tracheal suction procedure or when briefly pausing ventilation in invasive modes. The ventilator system is prevented from cycling without activating alarms.

When using a closed-suction system, DISCONNECTION should not be used. The O<sub>2</sub> boost function should be used instead for oxygenation purposes. Consider pre-silencing the alarms before suctioning.



### Important

Use DISCONNECTION for all disconnections of the patient circuit when ventilating in NAVA or in the neonatal patient category when leakage compensation is active.

# 4 Trends

Trend values are stored every 60 seconds and retained for a maximum of 72 hours. Stored events and system changes are also displayed here.

The time valid for the cursor position is displayed. If events have been stored, their number is displayed in the ring shown in the figure and an explanation appears to the left of this ring.

If a recording is saved at a time corresponding to the cursor position, a recorder is displayed. To view the recording, tap this recorder.



Tap Organize at the lower left of the TRENDS window to place the trends in the desired order by dragging and dropping the different trended values presented.

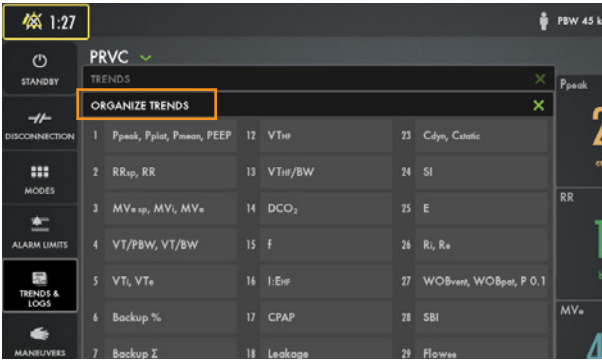

Tap the arrow to open the short trends. They can be set in the range 15 min to 72 hours.



# 5 NAVA and NIV NAVA

The NAVA® and NIV NAVA workflows facilitate the set-up and use of these modes.

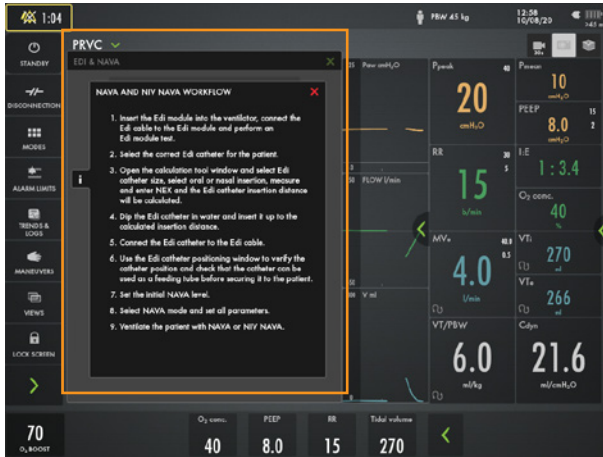



## 5.1 Edi catheter positioning

In the verticle field both the symbols on the representation of the Edi catheter and the color highlights on the leads show where the Edi signal is strongest. If no Edi signal is detected, there will be no such indications. Note that the color highlights on the leads change more rapidly than the symbols on the Edi catheter.



Indication of the strongest Edi signal

The edi waveform can be used to evaluate synchrony.



There is an Edi catheter positioning shortcut.



## 5.2 Edi monitoring

It is possible to monitor the Edi signal in Standby, when the patient is not ventilated.

The Edi signal is trended, with up to 72 hours of trends available from the quick menu and up to 12 hours available from the Edi monitoring window.

# 6 High Flow therapy

High Flow therapy can be selected in both invasive and non-invasive ventilation as well as in Standby.

Possibility to switch directly from invasive ventilation.

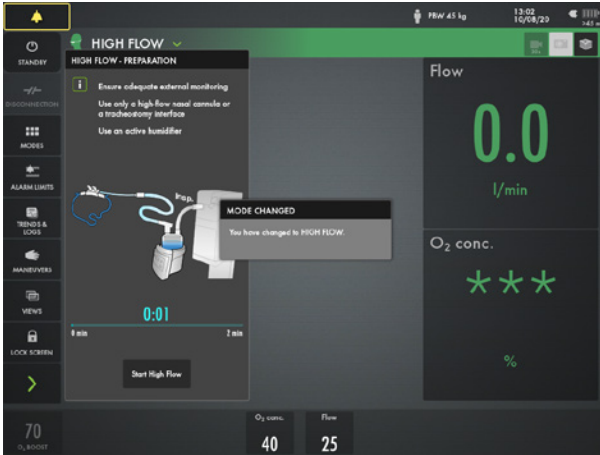

Edi monitoring is available during High Flow therapy.



# 7 Views

The ventilator system offers different views to suit different needs. They are accessed via the quick menu during ventilation.



## 7.1 Basic view

The view consists of two or three waveforms – pressure and flow waveforms are always present, together with the volume waveform if desired.

The BASIC view is not available if an Edi or CO<sub>2</sub> module is connected. All non invasive ventilation modes except NIV NAVA start in the BASIC view.



## 7.2 Advanced view

The view consists of two to five waveforms. Pressure and flow waveforms are always present, together with the volume waveform if desired and the Edi and CO<sub>2</sub> waveforms, if available are presented in two columns of numerical values.



## 7.3 Loops view

The view consists of up to three loops: pressure-flow, pressure-volume and volume-flow.



## 7.4 Servo Compass view

SERVO COMPASS® visualizes volume and pressure in relation to set targets in invasive modes.

If the driving pressure or total pressure exceeds the pressure limit, the pressure animation will change color.



## 7.5 Distance view

There are six large tiles displaying:

- Five enlarged numerical values
- Servo Compass, or pressure and flow waveforms, as well as the Edi waveform, if available.



## 7.6 Family view

Displayed information is minimized to:

- One column of numerical values.
- Alarms and messages in the status bar.
- The direct access settings bar.
- A dynamic representation (moving bubbles) shows that ventilation is in progress.

To exit the family view you can tap anywhere on the screen.



## 7.7 Screen layout

Tap and hold in the waveform area to open the screen layout window. The ventilator system can display a minimum of two waveforms and a maximum of five, depending on the view selected.

Pressure and flow waveforms are always shown except in the FAMILY view. (Note: In Nasal CPAP, only pressure and flow waveforms are available).



Choose filled or non-filled waveforms



Filled waveforms



## 7.8 Panel lock

It is possible to lock the screen for example for cleaning.  
Tap and hold to unlock.



## 7.9 Batteries

If the ventilator system is running on battery power, the battery symbol turns yellow and the mains power symbol disappears. The estimated remaining battery time in minutes is always displayed, regardless of the power supply in use.



# 8 Media

## 8.1 Recording

A 30 second long recording will be made starting 15 seconds before, and lasting until 15 seconds after the time the recording was initiated.

The recording will be stamped with the date and time that it was initiated and will be saved under the Recordings tab in the MEDIA library. Forty recordings can be saved.

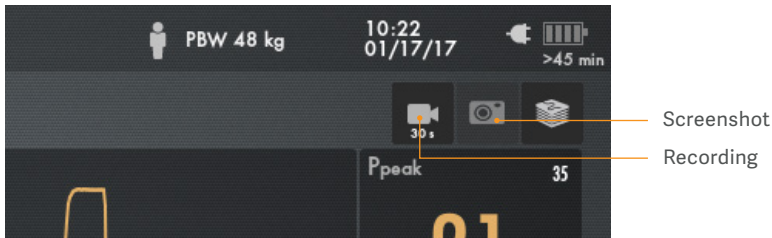

## 8.2 Screenshots

The screenshot will be stamped with the date and time it was taken and saved under the Saved screens tab in the MEDIA window. Forty screenshots can be saved.

All screenshots and recordings can be transferred to a USB memory stick. The USB port is under the user interface.

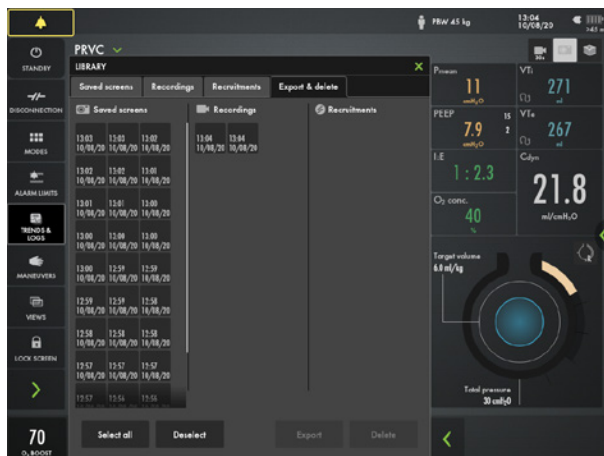

# 9 Neonatal patient category

## 9.1 Invasive leakage compensation

Invasive leakage compensation is available in the neonatal patient category to compensate for the leakage around uncuffed endotracheal tubes commonly used when ventilating neonatal patients.

Servo-u has real volume target in PRVC and VS, the leakage loss is added to inspiratory volume.

Compensated values in the user interface will show the symbol  for leakage compensation.

The Leakage compensation maintains PEEP, compensates trigger and end inspiration sensitivity, and compensates measured values, as well as volume delivery in PRVC and VS to assure that the set tidal volume reaches the lungs of the neonatal patient.

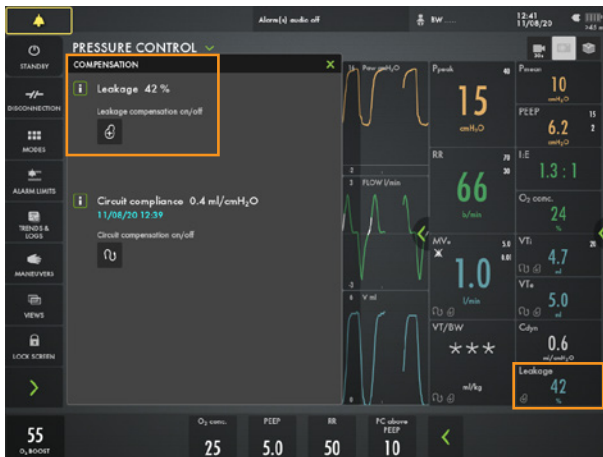

## 9.2 Volume restriction

For the neonatal patient category, the ventilator system has a volume restriction. This means that the alarm limit set for VT<sub>i</sub> restricts volume delivery, so that a higher volume than set by this limit will not be delivered. This applies in: PC, PS, AUTOMODE® PC PS and all SIMV modes.



## 9.3 PRVC

PRVC ensures a preset tidal volume during a preset inspiratory time at a preset respiratory rate. The inspiratory pressure level is constant during each breath, but automatically adapts in small increments on a breath-by-breath basis to match the mechanical properties of the patient's lungs, thus ensuring delivery of the target volume.



## 9.4 Y sensor

For tidal volumes below 10 ml, it is recommended to use a Y sensor to increase the accuracy of gas delivery, monitoring and triggering response during spontaneous breathing.

When the Y sensor is active, the flow through the sensor will replace the bias flow as source for flow based triggering. The pressure is measured at the Y piece via a pressure line.

To guarantee that waveforms and measured values are always displayed on the screen, the internal pressure and flow sensors are at all times active as backup. Their readings are compared with the Y sensor measurement. The Y sensor is disabled if there is a significant deviation or malfunction.



# 10 Heliox

Heliox can be used on Servo-u (optional). The HeO<sub>2</sub> gas is connected to the Servo-u ventilator system via a Heliox adapter, which is connected to the Air/HeO<sub>2</sub> inlet. Heliox can be combined with all ventilation modes, from invasive to NIV, High Flow therapy and nebulization. It is not available in the neonatal patient category. The automatic gas identification function makes it possible to change gas type during ventilation by simply changing the gas supplied to the ventilator system. The HeO<sub>2</sub> indicator is visible together with the ventilation mode name at all times and the He is indicated in O<sub>2</sub> metric setting.







This document is intended to provide information to an international audience outside of the US. Servo-u may be pending regulatory approvals to be marketed in your country. Contact your Getinge representative for more information.

Getinge is a global provider of innovative solutions for operating rooms, intensive care units, sterilization departments and for life science companies and institutions. Based on our firsthand experience and close partnerships with clinical experts, healthcare professionals and medtech specialists, we are improving the everyday life for people, today and tomorrow.

**Manufacturer** · Maquet Critical Care AB · Röntgenvägen 2 SE-171 54 Solna · Sweden · +46 (0)10 335 73 00

**[www.getinge.com](http://www.getinge.com)**