



Servo-air

– hands-on guide

Introduction

– to lead you into it

There are different ways to navigate the user interface, adjust settings and get support.

The objective with this Servo-air® hands-on guide is to guide you through some of the most important steps you need to familiarize yourself with when starting to use the Servo-air ventilator.

To go through these exercises you need a Servo-air System version 4.0, O₂ supply, patient circuit and a test lung. The exercises can be done individually or in sections. It takes approximately 30 minutes to do the entire Servo-air hands-on guide. Knowledge Check questions with answers can be found at the end of the guide.

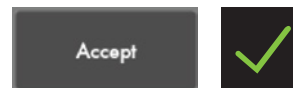
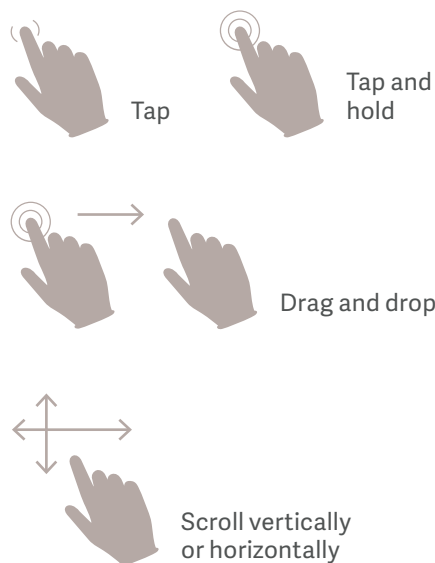

Confirm the settings by tapping Accept or the green check mark.

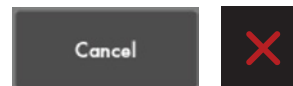

Exit settings without changing by tapping Cancel or the red x.



Close by tapping the green x.

Servo-air 4.0. This guide is intended for hospital personnel as a hands-on training using the Servo-air ventilator. It does not cover all aspects of the Servo-air ventilator. Please see the user's manual for more information. Some modes and functions are options and might not be included.

Setting up the Servo-air

Follow step by step (see corresponding images and notes):

1. Mount the ventilator to the cart by tilting the ventilator to fit the two front clamps in position on the mobile cart. Press down the rear end of the ventilator to fit the rear clamp in position. Lock the ventilator system with the locking clamp. Make sure that the ventilator system is firmly mounted on the mobile cart.

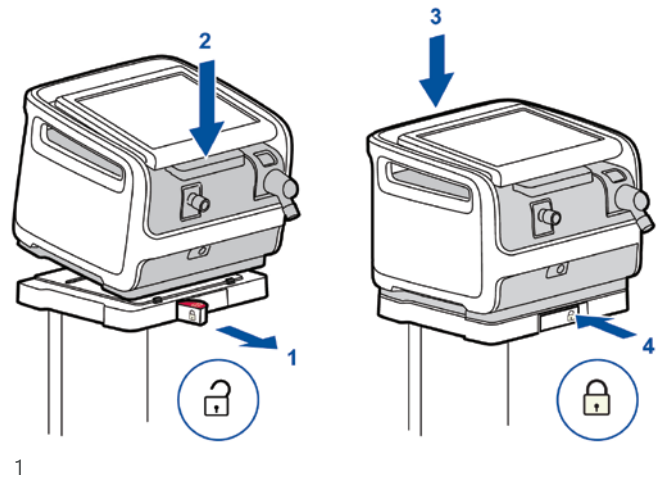

2. Plug in the power cord.

3. Switch ON the ventilator.

NOTE: When switching on the Servo-air, you need to pull the ON/OFF switch downwards.

4. Connect the oxygen hose.

5. Lock the wheels. It's important to lock the wheels when the ventilator is in use to avoid accidental movement of the ventilator.

6. Start the **PRE-USE CHECK**. (You need the test tube during the Pre-Use Check).

7. Follow the instructions on the screen.

8. Included in the Pre-Use Check is the patient circuit test. Connect the patient circuit.



NOTE: Pre-Use Check includes pressure and flow transducers calibration. Each test starts automatically after the previous test is completed. The patient circuit test is included in the Pre-Use Check, but can be selected separately.

9. Connect a test lung to the patient circuit.

10. Choose patient category: **ADULT. (1)**

11. Choose Ventilation type: **INVASIVE. (2)** (You can also choose NON INVASIVE here).

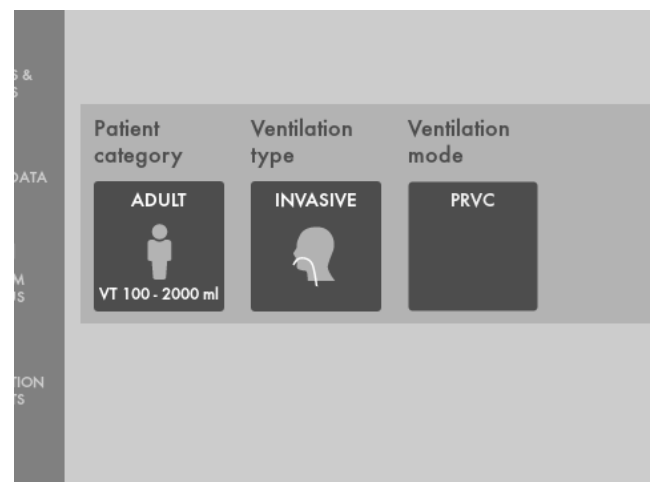

10-11

1

2

- Tap on Ventilation mode **PRVC**. (1)
(Depending on start up the configuration a different mode can be shown here.)

NOTE: Some modes are options and might not be included. Information is available for each mode.

- Then tap and hold the **PRVC** tile. (1)
- Close by tapping **X**.
- Select Mode by tapping **PRVC**.
- Change the:
 - Tidal volume to 350 ml
 - Respiratory rate to 18 b/min
 - PEEP to 10 cm H₂O
- Accept the mode settings.

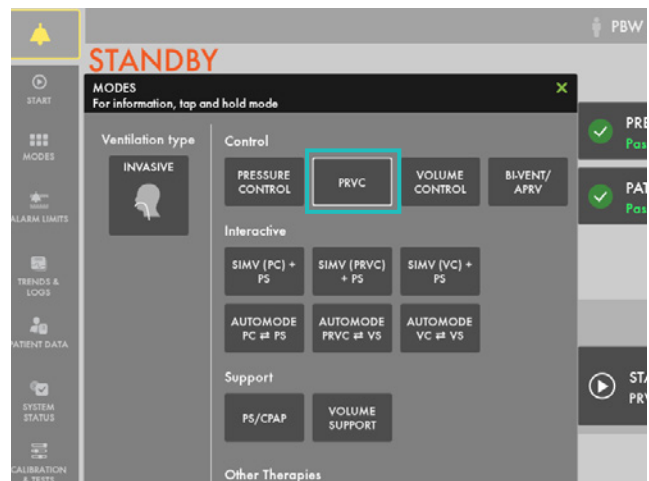

12-15

1

Alarms

- Go to **ALARM LIMITS** in **QUICK MENU**.
- Change the alarm limits:
 - Alarm sound: 6
 - Ppeak: 30 cm H₂O
 - RR (Respiration Rate): High 12 b/min
 - MVe (Minute volume): Low 6.0 L/min



16-17

- ACCEPT** the alarm settings.

- Tap **START VENTILATION**.
- The alarms are silenced for 30 seconds after starting ventilation. (2)

NOTE: Alarms can be in one of three colours: red, yellow or blue, depending on priority.

- Tap the activated alarm in message bar (3) and read the messages.

NOTE: The number of alarms that are active are displayed in the status bar. (4)



22-24

24. Tap the red tile in the numerical values **MVe** alarm.
NOTE: By tapping the activated alarm in the numerical values field, you gain access to the alarm setting (shortcut).

25. Go to alarm limits. Adjust the alarms so none are active.
NOTE: The arrow indicates the current measured value. (1)

26. Activate the **AUTOSET** function by tapping. (2)
NOTE: The alarm autaset function can only be used in controlled modes.

27. **ACCEPT** the alarm settings.

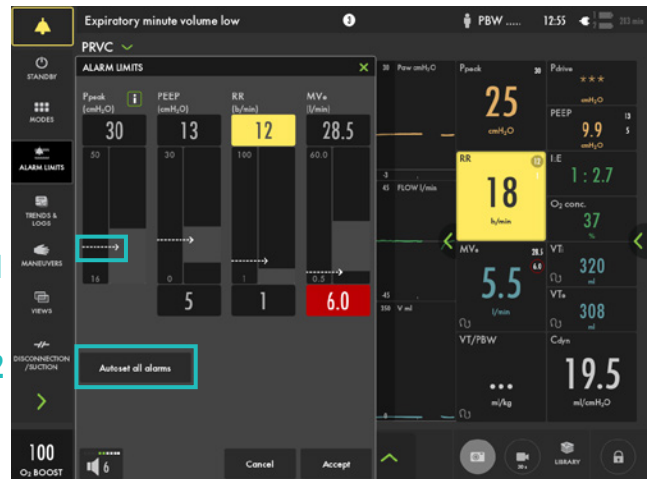

25-27

NOTE: When ventilating, you can see that the patient circuit test has been performed by the symbol  – The symbol will not appear if a patient circuit test has not been done. (3)



Note

28. Decrease the PEEP to 4 cm H₂O (use the direct access keys) and increase the scale by tapping the **+**. (4) Then increase the PEEP to 26 cm H₂O. Cancel the settings by tapping the **✗**.
NOTE: The color changes when the settings are changed outside the normal range.



28

VT/PBW

29. Tap **PBW** or the **VT/PBW** to open PATIENT DATA. (1)
30. Enter gender **FEMALE**.
31. Enter **HEIGHT** 160 cm.
32. Enter **WEIGHT** 75kg.

NOTE: The predicted body weight is often not the same as the patient's actual weight (in Pediatric patient category the actual weight is entered).

33. Check the ml/kg measurement. (2)
34. Go to the direct access bar and change the **TIDAL VOLUME** so you receive 6 ml/kg. (3)



29-33



34

Mode setting

35. Tap the mode **PRVC** and open the mode setting. (4)

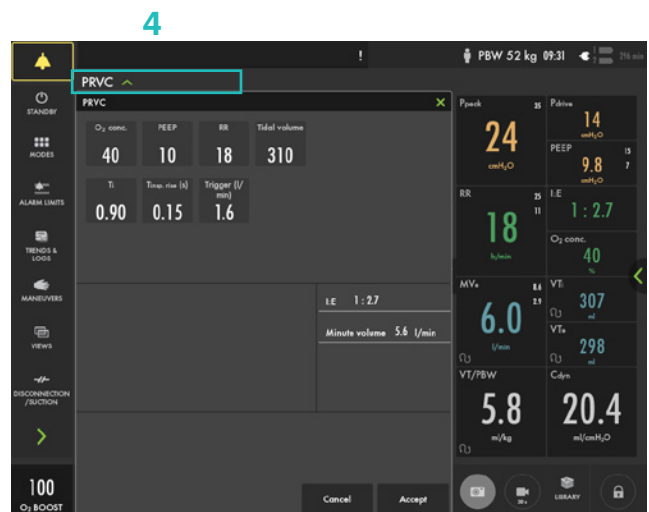

35

36. Change the **TRIGGER** value to pressure triggering -1 cm H₂O.

NOTE: Read the text by the scaling. Less patient effort and more patient effort. (1)

37. Change the I:E (or I:E if this is configured).

NOTE: The changes of the dynamic images.

38. **CANCEL** changes.



36 1

39. Make a quick change of O₂ to 100%. Change the O₂ setting in the direct access bar to 100% by tapping on the 100% directly on the sliding scale. (2)

40. **CANCEL** the changes by tapping the .



39-40 2

41. Tap **MODES** in the QUICK MENU and choose PS/CPAP.

42. Change the **END INSPIRATION** to 40 % and then to 60%. Look at how the dynamic image changes.

43. **ACCEPT** 60%.

44. **ACCEPT** PS/CPAP mode.

45. Compress the test lung to trigger breaths.

NOTE: The white indicates the triggering in the waveforms, depending on how the trigger is set (pressure or flow) the colour indication changes - if pressure triggering is set- white indication in pressure waveform. If flow triggering is set- white indication in flow waveform. Also there is a lung on the screen indicating the triggered breath.



45

46. Stop compressing the test lung.

NOTE: The colour changes to bold white for PC and the BACKUP settings. The mode and settings that are not active are grey. (1)

47. Tap the  in the direct access bar (2), you then have access to all the mode settings directly.

48. Go to **MODES** and change back to **PRVC**.

NOTE: It is marked previous. (3)

49. Accept previous settings.



3

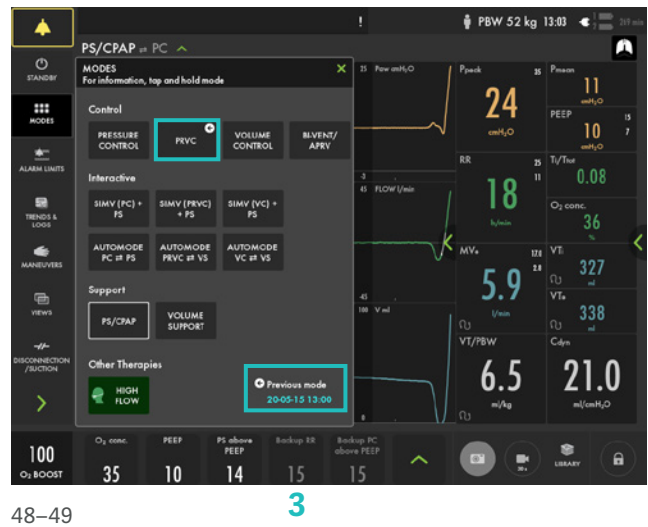

Views

50. Go to **VIEWS** in **QUICK MENU**. (4)
Change to BASIC view.

51. Use the  to find additional values. (5)

52. Go through the different views; **DISTANCE, FAMILY, LOOPS** and **SERVO COMPASS** view. If Servo Compass view is available tap on the Servo Compass. Note that you can change the targets for ml/kg and driving or total pressure. Compress the test lung.

NOTE: The pressure symbol turns red. Change back to advanced view.

53. Go to **SCREEN LAYOUT**. (6)

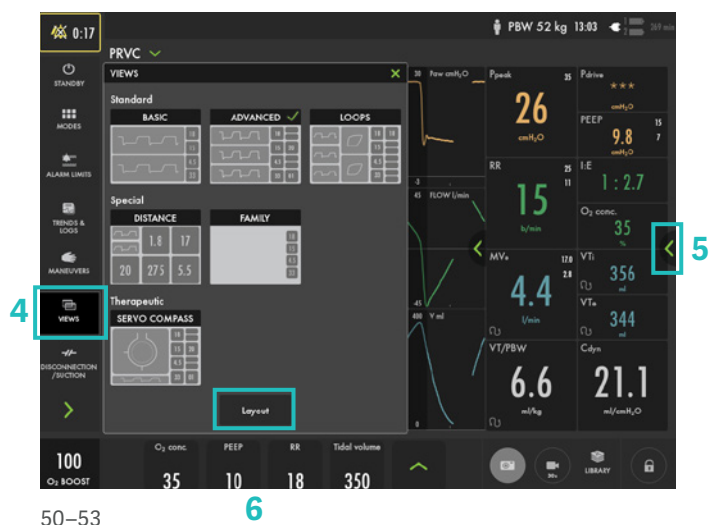

NOTE: Here can the Servo Compass be switched on/off.

54. Change to filled waveforms by tapping the waveform image. **(1)**
55. Change back to non-filled waveforms.



54-55

56. Tap the **RECORDER** once and tap the **CAMERA** in the status bar three times. **(2)**

NOTE: A 30 second recording will be made starting 15 seconds before and lasting until 15 seconds after the recording is initiated.

57. Choose **(3)** to access **MEDIA**. Navigate between the different screenshots and the recording.

NOTE: Screenshots are displayed at the bottom of the window.

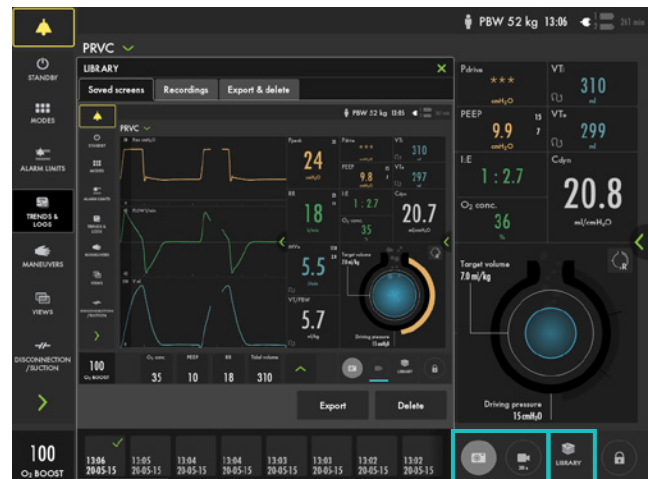

56-57

2 3

58. Find the USB port at the back. **(4)**

NOTE: You can use a USB memory stick to export the data (e.g. screenshots).



58

4

Disconnect/ Suction

59. Go to **DISCONNECTION/SUCTION** in **QUICK MENU. (1)**
60. Change the **O₂ CONCENTRATION** to 60%. **(2)**
61. Accept **DISCONNECT/SUCTION** function.
62. Disconnect the test lung.
63. Reconnect the test lung.
64. **CANCEL** post-oxygenation.

NOTE: When disconnection/suction is activated the ventilator system is prevented from cycling without activating alarms. The disconnection/suction function should not be used if closed suction system is used.

Maneuvers

65. Go to **MANEUVERS** in **QUICK MENU. (3)**
66. Activate **MANUAL BREATH** by tapping.
67. Go to **STATIC MEASUREMENT.**
68. Tap **INSPIRATORY HOLD** and hold for 4 seconds, and then **EXPIRATORY HOLD** for 4 seconds. **(4)**
69. Observe the PEEP_{tot} value.

NOTE: PEEP_{tot} value is the set PEEP + intrinsic PEEP.

70. Tap the **i** You can find more information about static measurement setting there.

NOTE: The information sign can be found in different positions on the Graphic User Interface.



59-64

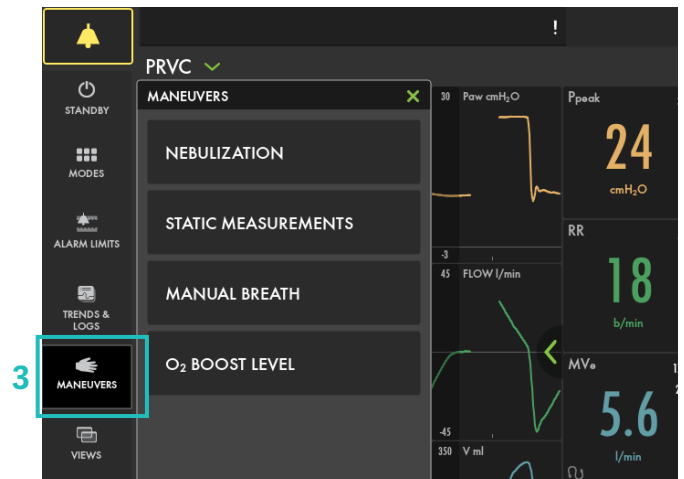



65



67-70

71. Go to **NEBULIZATION**.

NOTE: You can choose continuous nebulization  or a nebulization period . The time for nebulization can be changed. When nebulization is activated there will be the corresponding nebulization symbol on the screen. By tapping the symbol you can stop nebulization.

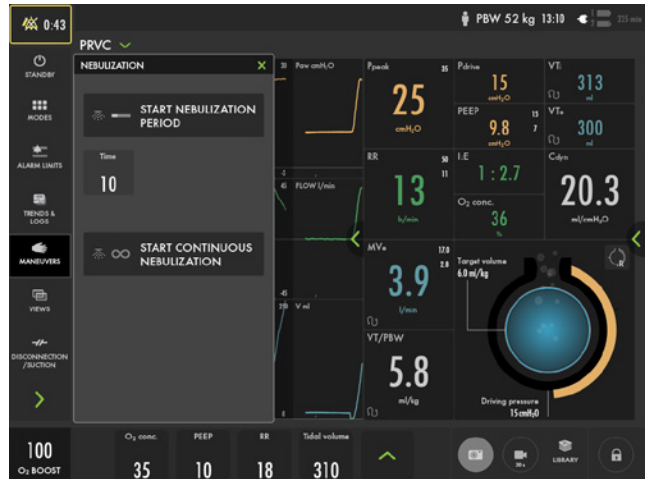

71

72. The nebulizer connection is at the front of the ventilator. (1)



72

Battery

73. Unplug the mains cable.

74. Click on the battery symbol . (2)
The battery compartment is divided into two slots – slot 1 (optional) and slot 2 (main). The battery module in slot 1 may be exchanged during ventilation.

NOTE: You can see how much capacity remains for each battery.



74

Lock screen

- 75. **LOCK SCREEN** is found in the lower right corner. Lock the screen. **(1)**
- 76. Tap anywhere on the screen and see what happens.
- 77. **UNLOCK** the screen by tapping on the Locking Symbol.



75-77

O₂ boost

- 78. Activate **O₂ BOOST** by tap and hold. **(2)**
- NOTE: O₂ boost is active for one minute.**
- 79. **CANCEL** O₂ boost by tapping **✗**.



78-79

- 80. Go to **MANEUVERS** and select **O₂ BOOST**. Unlock the 100% O₂ boost by tapping the 100% lock symbol. **(3)**
- 81. Observe the new **O₂ BOOST** level. Change the **O₂ BOOST LEVEL** to 40% and accept **✓**.



80-81

3

Trends

82. Go to **TRENDS** in the **QUICK MENU** . (1)
83. Change the trend scale to 1 hour. (2)
NOTE: Trend values are stored every 60 seconds and retained for a maximum of 72 hours.
84. Drag the cursor and note that each event/changes have been trended.
85. Tap **ORGANIZE** to change the order of the trends. (3)
86. Put the RR sp, RR at the top by dragging and dropping **TRENDS**.

NOTE: You can see the trend of VT/PBW.

87. Close the window by tapping **X**.



82



83-87

2

Stop ventilation

88. Tap **STANDBY** in **QUICK MENU** and then tap and hold **STOP VENTILATION**.

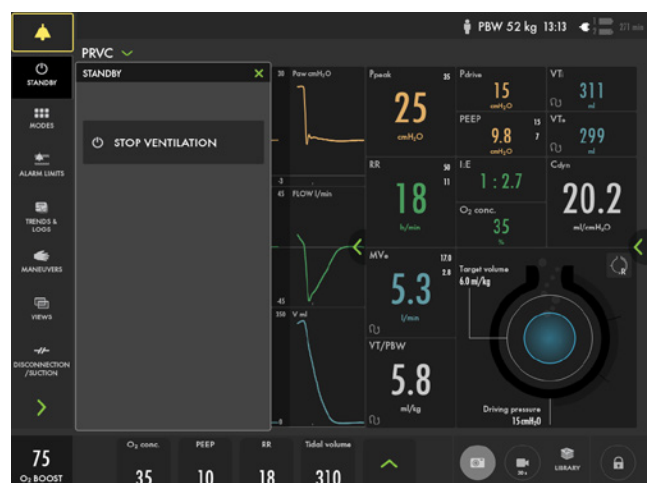

88

Knowledge check

1. Which priority level does the red alarm have? HIGH, MEDIUM or LOW priority?

2. Can autoreset of alarm settings be used in supported modes?

3. How can you see on the screen that the patient is triggering?

4. What values need to be entered in order to get the parameter for ml/kg?

5. Can O₂ Boost level be changed?

6. Where on the screen can the alarm volume be changed?

Answers

1. Red – High Priority alarms. Yellow – Medium priority alarms. Blue – Low priority alarms.
2. Autoreset is not available in supported or NIV modes or in STANDBY because the ventilator system requires patient values in order to propose alarm limits.
3. There is a lung on the screen indicating the triggered breath. Also there is a white indication in the waveform (if pressure triggering is set- white indication in pressure waveform and if Flow triggering is set – white indication in flow curve).
4. You need to enter the gender and height for adults (PBW) and the weight for pediatric patients to get ml/kg value.
5. Yes, go to Manuevers – O₂ boost level.
6. The alarm sound level can be changed in the alarm menu.



This document is intended to provide information to an international audience outside of the US. SERVO-air may be pending regulatory approvals to be marketed in your country. Contact your Getinge representative for more information.

Getinge is a leading global provider of innovative solutions for operating rooms, intensive-care units, hospital wards, sterilization departments and for life science companies and institutions. Based on first-hand experience and close partnerships, Getinge offers innovative healthcare solutions that improve every-day life for people, today and tomorrow.

Manufacturer · Maquet Critical Care AB · Röntgenvägen 2 SE-171 54 Solna · Sweden · +46 (0)10 335 73 00

www.getinge.com