



Surgical Lights

The ultimate guide



This document is intended to provide information to an international audience outside of the US.

What is important in a surgical light?

Surgical lights are medical devices designed to effectively illuminate the patient's body during surgical procedures, diagnostics, or treatments. These lights must follow a strict set of specifications to ensure efficient and effective illumination that leads to improved visibility and better patient outcomes.

Surgical lights are arguably the most important tool in the operating room; if surgeons can't see, they can't effectively diagnose or treat the patient. Most people would assume that the brighter light is the better light. However, more light does not correlate with improved visual acuity. Research has shown that quality of light — not quantity — matters most in the operating room (OR).

Factors that contribute to high-quality surgical lighting include:

- Intensity
- Width
- Depth
- Shadows
- Color
- Heat
- Safety

Our long experience taught us to ideally balance these factors to deliver the perfect illumination for surgeons.

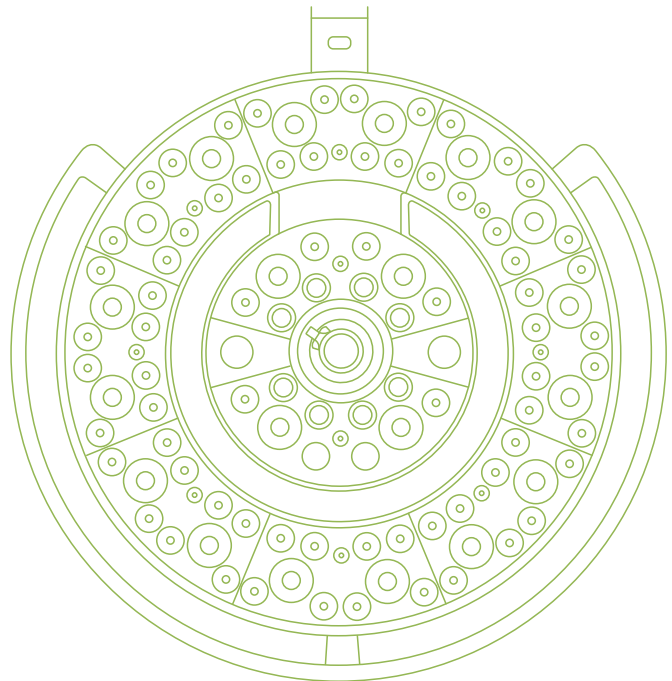

The history of surgical lighting

Surgical procedures predate the invention of the electric light. The amount of light varied dramatically based on weather and time of day, ranging from 10,000 to 80,000 lx. But as we've all experienced, daylight also casts shadows. This variable, shadow-prone illumination made it difficult for surgeons to accurately see into the surgical cavity to make accurate diagnoses and perform delicate work.

Efforts were made to supplement the natural lighting with hand-held artificial light sources that were brought closer to the patient at the surgeon's request. Fixed arc lights were directed toward a stationary point on the surgical table. Spherical mirror lights, like car headlights, were mounted in the corners of the room. While this added brightness, none of these options solved the problem of cast shadows.

These early lamps heated rapidly and led to an unbearable rise in temperature on the surgeon's head and neck, and

contributed to the drying of patients' exposed, delicate tissues. Many researchers studied the problem to both improve surgeons' comfort and patient outcomes.

In 1919, Professor Louis Verain of the Faculty of Sciences of Alger developed an innovative lighting device that delivered concentrated, directable illumination without cast shadows. His "scialytic" light (from the Greek words for "light dissolving") improved surgeons' visibility and enabled procedures to be performed at any hour of the day. This innovation transformed surgical lighting and provided the foundation for subsequent lighting research.

By the 1960s, halogen bulbs became the light source of choice. They generated very bright light comparable to noon sunlight on a Mediterranean beach. By the 1990s, that illumination would double to 200,000 lx — twice the intensity of bright sunlight!



Figure 1: An operating room in France, 19th Century

What is a scialytic light?

One or more light sources are arranged in the center of the device. The rays are reflected by inclined mirrors positioned on a circular surface. The resulting illumination area superimposes all the reflected light rays and compensates for the shadow cast by the practitioner's hand.



Figure 2: In the 1940s, we still can see the presence of windows in the operating room (Photo credit: Private archive BBT)

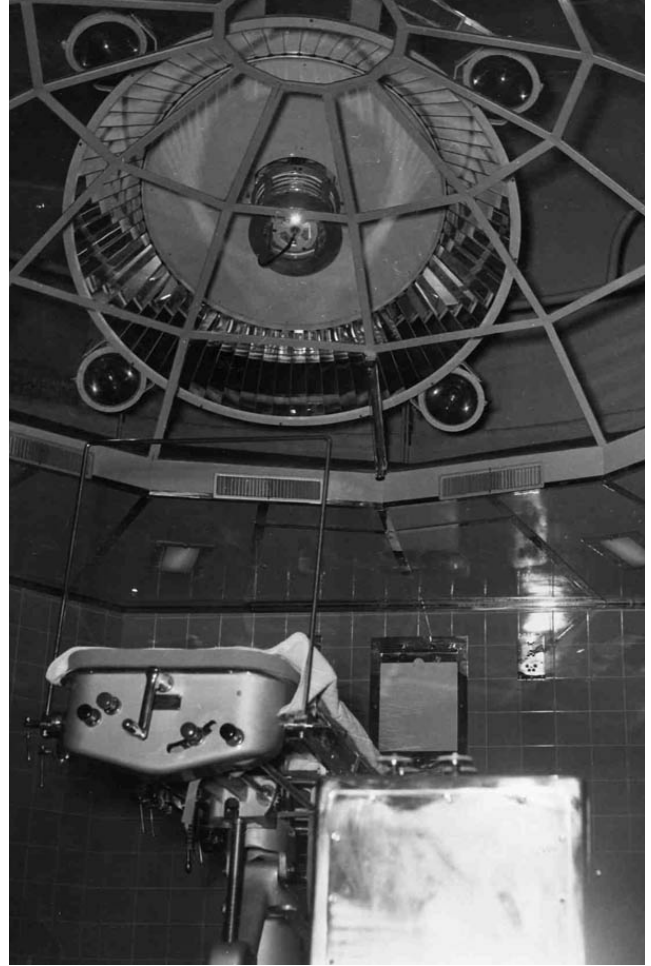

Figure 3: A very large surgical model separated from the operating theatre by a canopy. (Photo credit: Private archive BBT)

The intensity of the halogen lighting of the 1990s led to eye fatigue and diminished surgeons' effectiveness and induce a risk of tissue dessication for patients.

Today, most surgical lights use long-life LED. These use less energy and generate less heat, producing crisper, cooler illumination that gives surgeons the visibility they need to make effective diagnostic decisions.

Central illumination: The overall measurement of lighting intensity

Illumination is a measure of the intensity of light that hits or passes through a surface, as perceived by the human eye.

It is measured in lux, the standard measurement of one lumen per square meter. It is measured with a lux meter, a device that measures light intensity. To help understand lux in the context of real-world scenarios, here are relative lux measurements for some familiar circumstances.

Illuminance (lux)	Surfaces illuminated by
20-50	Public areas with dark surroundings
320-500	Office lighting
10,000-25,000 (10-25 klx)	Full daylight (indirect sun)
100,000 (100 klx)	Direct sunlight in summer

For surgical lights, the central illumination is measured at two different distances:

- The reference distance (D_{Ref}) defined by the manufacturer
- The maximum illumination distance (D_{MI})

The maximum illumination at D_{Ref} ($E_{C,Ref}$) must be in between 40,000 and 160,000 lux. Maximum illumination at D_{MI} ($E_{C,DMI}$) must never exceed 160,000 lux.

More illumination is not necessarily better. Too much illumination can cause glare, contrast loss, and eye fatigue. Different types of procedures also require different amounts of light; visibility into a deep cavity requires more illumination than a surface wound. In surgery, the quality of light matters more than the amount of light.

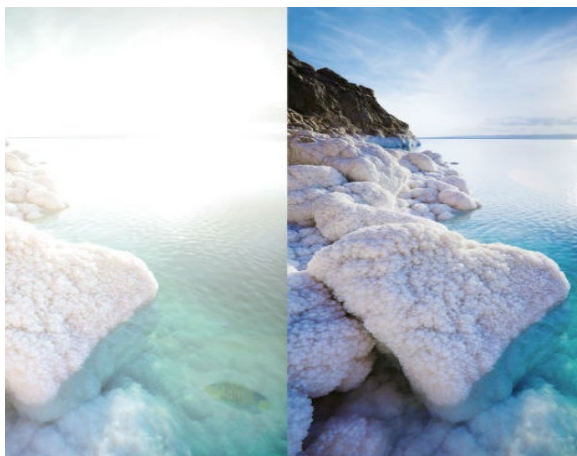
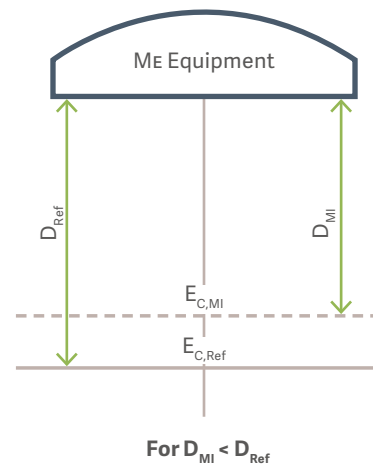

Figure 4: Too much illumination can result in glare, contrast loss, and poor visualization

Industry standard IEC 60601-2-41

In 1977, a series of technical standards were developed by the International Electrotechnical Commission (IEC), to ensure the safety and essential performance of medical electrical equipment. In 1990, a committee of international experts met to devise a dedicated section defining surgical lights. The IEC Standard 60601-2-41, titled "Particular requirements for the basic safety and essential performance of surgical luminaires and luminaires for diagnosis", has been in effect since December 1999. Since then, several revisions have been published. The current standard, presented as recommendations for international use, is IEC Standard 60601-2-41:2021.



"After 1 hour light exposure (typically 80,000 Lux) a long-term effect (in which red and green spectral lights are mixed to match a monochromatic orange) can be measured reliably for as long as 5 hours after the end of the adaptation period"

Adaptation of colour vision to sunlight. G. Jordan, J.D. Mollon. Nature. 386, 135 - 136 (13 March 1997).

"A too high illuminance level, whatever the correlated colour temperature is, disturbs the colour perception of the subject"

Colour perception in medical environment and under high illuminance levels. Barneoud J, Breyse JP, Testa R, Dalens H, Coulangeon LM, Michel S. CGIP'2000.

Light field diameter: The horizontal plane of available light

The light field diameter defines the plane surface where the light will be available — the width of available lighting on a horizontal plane. The central illumination is where the amount of light is at its maximum; moving away from the center, the light will smoothly decrease.

Two diameters of light are measured.

- **d10:** The diameter in which the center is $E_{C,Ref}$ (maximum illumination at the reference distance) and the outer limit is 10% of $E_{C,Ref}$
- **d50:** The diameter in which the center is $E_{C,Ref}$ and the outer limit is 50% of maximum illumination

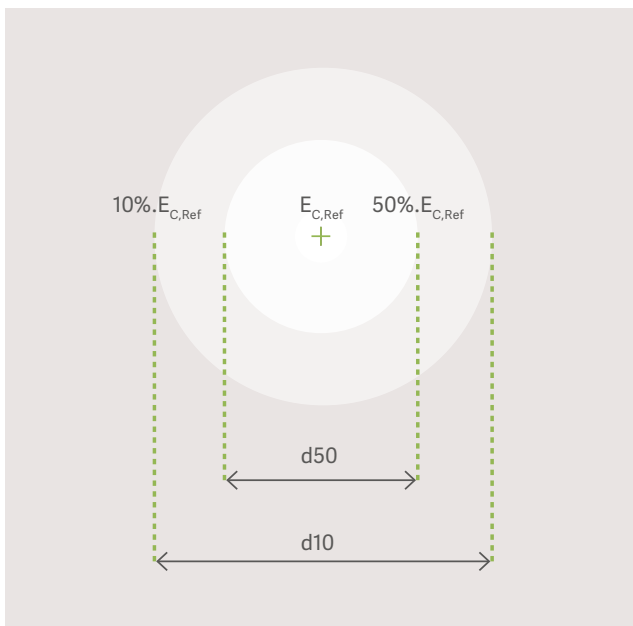

There is no minimum or maximum diameter indicated in the IEC standard because the diameter of the light should be adapted to the incision size. It should:

- Cover the full surgery incision with no dark areas to maximize visibility
- Avoid peripheral light reflection by having too much light illuminating the surroundings of the cavity

Each OR hosts a wide variety of surgical procedures, each with different light field requirements. The challenge of surgical lighting is maintaining the same amount of light whether the light field has been adjusted for a large or small incision size. This is a complex technical challenge, as it is easier to concentrate light on a small field than a large one. For many lights, the technical features are mentioned for the small light field, but can drastically decrease when enlarging the light field diameter.

Lighting homogeneity

Homogenous lighting reduces glare. The IEC standard defines homogeneity to limit bright and glaring light at the center of the light field ($E_{C,Ref}$, the point of maximum illumination, noted above) contrasting with darkness.

To evaluate the homogeneity, the diameter ratio is used:
 $d50/d10 > 0.5$

That means that d50 must be at least half of d10. The closer d50 is to d10, the more homogeneous and well-distributed the light field is on the horizontal plane.

Volume of light: The vertical plane of available light

Surgeries are three-dimensional procedures, ranging from the incision point at the surface to the deepest cavities. This is why we define not just the diameter of light on the horizontal plane, but also the volume of light on a vertical plane, also called the column of light.

For safety purposes, the max. illumination along the vertical axis shall never exceed 160,000 Lux.

The total volume is composed of two different measurements: $L_1 + L_2$. The distance L_1 is measured between 1m from the light head, moving up towards the light itself, reaching 60% of $E_{C,Ref}$. In real life this position would be seldom used, as the surgeon isn't usually operating too close to the light head, which is frequently positioned at a distance of 1.10m to 1.20m from the patient.

The distance L_2 is measured from 1 m from the light head through a range downward within which 60% of $E_{C,Ref}$ is maintained. This measurement evaluates how much light will remain inside the cavity when operating. If the light head is positioned more than a meter from the surface of the cavity, as is common, the available light is already reduced. A good L_2 value has more relevance to the surgical experience than the whole volume of light.

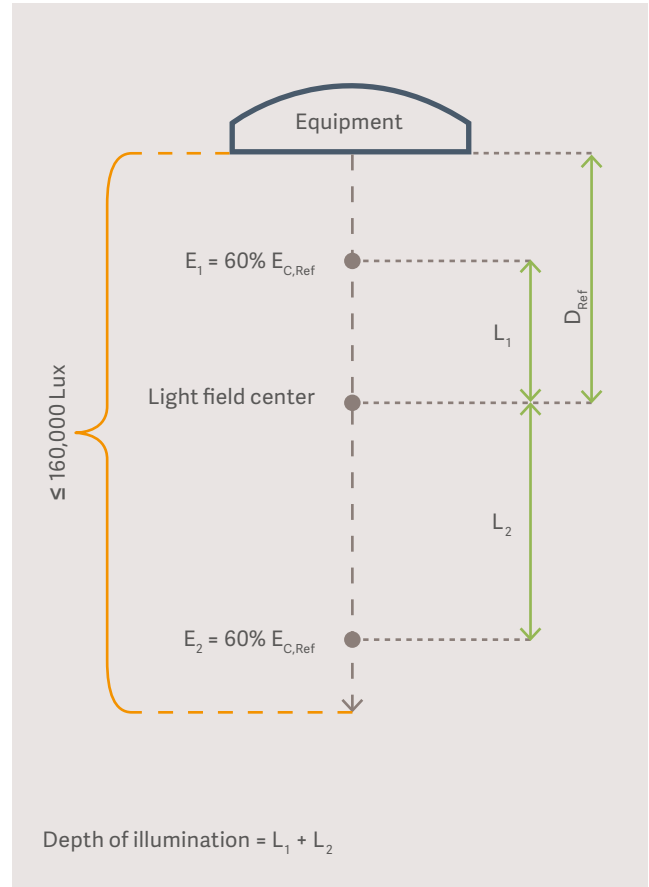

The volume of light measures the range from the light head within which you can maintain 60% of illumination. It gives information on the range of distances within which lighting is sufficient without having to move the lighthouse.

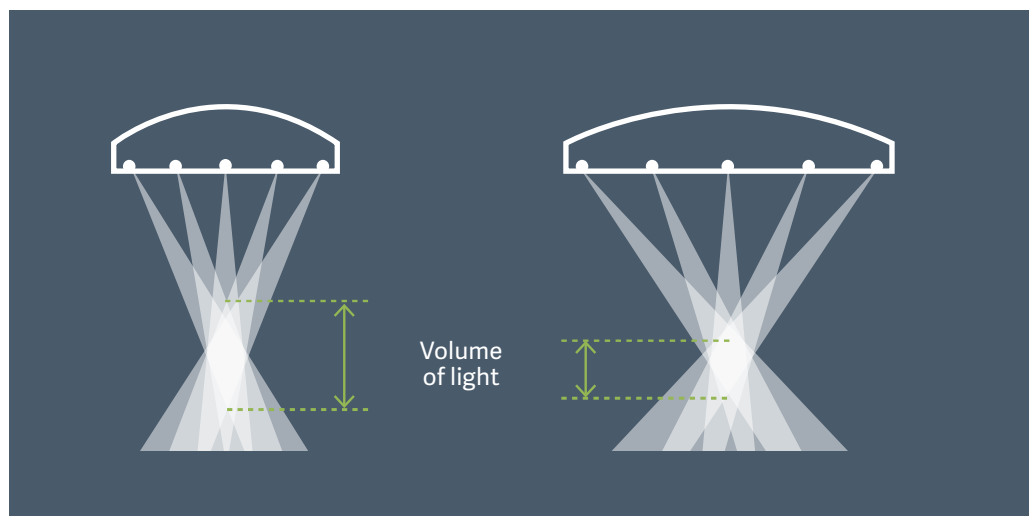

Different choices of technology:
On the left, no need to focus to obtain a large volume of light.
On the right, focalization is needed to adjust the volume of light to the surgical field.

Shadow management: Compensating for the human element

Measurements of central illumination, light field diameter, and central illumination are performed on the light head alone. Shadow management adds humans into the equation.

During a surgical procedure, surgeons stand between the light head and the patient; their hands and heads cast shadows that can affect visibility into the surgical cavity. Shadow management defines how the light is designed to assure adequate illumination to compensate for these shadows. The remaining light is also known as the useful light. If the shadow management is poor, the useful light available inside the cavity won't be enough. Useful light is the main feature to consider to ensure adequate light inside the cavity.

A test mask simulates the surgeon's head blocking light beams to establish the usable remaining light. All tests dimensions are defined in the standard to ensure consistent comparison across all OR light suppliers.

Test types include:

- **One mask:** This test simulates the remaining light when a surgeon is working below the light head. A mask of 210 mm represents a human head. This test is less representative of reality as the mask doesn't take into account the shoulder/body accompanying the head.
- **One simulated cavity:** This test simulates the remaining light inside a 50 mm diameter and 75 mm deep cavity. Some light beams coming from the periphery cannot reach inside the cavity.

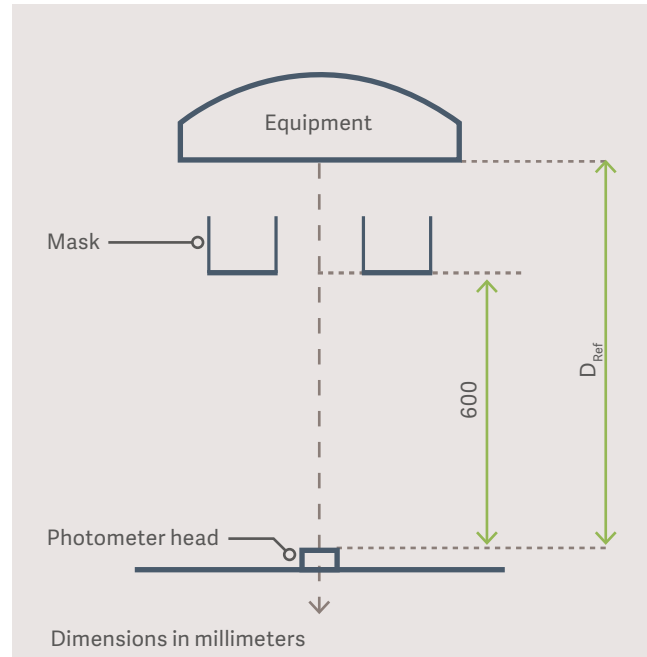

- **One mask and a simulated cavity:** This simulates the remaining light with one surgeon below the light head operating in a 50 mm diameter and 75 mm deep cavity.
- **Two masks:** This test simulates the remaining light when two surgeons are operating below the light head. The shape of the light head and mask position can influence results; an average of four mask positions are provided, moving them with a 45° angle.
- **Two masks and a simulated cavity:** This simulates the remaining light with two surgeons operating below the light head in a 50 mm diameter and 75 mm deep cavity.

Shadow management is the most interesting element in terms of assessing the useful light available for medical staff.

It also gives a significant clue about light stability as surgeons move below the light head. It is important to minimize large variations in illumination that can induce eyestrain and compromise visual acuity during procedures.

Important considerations in shadow management

Several parameters have an impact on the shadow management:

- The illuminating surface: A good distribution of light sources on the light head surface minimizes the impact of obstructions.
- Homogeneous distribution: Overlapping light fields ensures constant homogeneity of the light field without creating any dark areas due to obstructions.
- Light coming from the periphery: Larger light heads have better shadow management as the light coming from the periphery plays a major role in shadow dilution. But it can be detrimental to the useful light for narrow and deep cavities.

There are no mandatory values for shadow management in the IEC standard; the results just need to be specified.

However, the useful light needs to be stable to avoid variations in illumination and eyestrain and to support better patient outcomes.

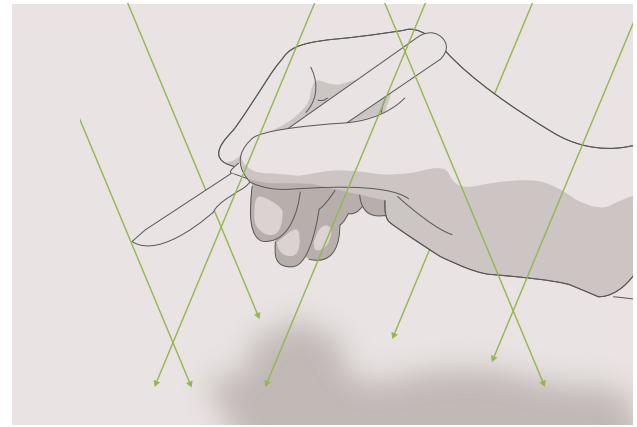
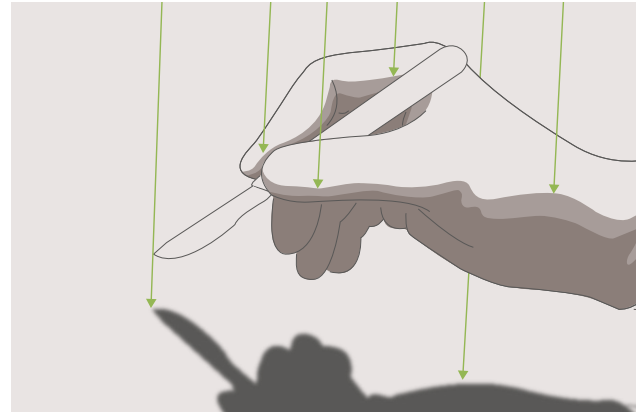

"Thirty percent of the surgeons had eyestrain, and those with eyestrain had three times as much musculoskeletal strain"

"Surgeons or assistants who are having any visual problems can make serious treatment mistakes"

Lighting Recommendations in Operating Theatres. H. Hempälä; G. Johansson, P. Odenrick, K. Akerman and P.A. Larsson. Helsingborg Hospital, Sweden.

Excellent volume of light but poor shadow dilution

Poor volume of light but excellent shadow dilution

A good surgical light combines many factors

Lighting is something that we don't really notice or appreciate unless it is deficient. A good surgical light is always a compromise between different characteristics. None of the factors previously discussed can be design separately. These elements work together to create an effective, efficient light that allows the surgeon to focus on the patient — not on the light.

Color temperature and color rendering index (CRI)

Color Temperature is measured in the unit Kelvin (K) and is a method for measuring the color of light emitted from a lamp. The color is correlated to the color of a piece of steel (black body) heated to a prescribed temperature. The piece of steel will glow at different colors depending on the temperature it is to

which is heated, varying from red hot through amber then white and finally a bluish-white.

Color temperatures over 5000 K are called "cool colors" (bluish), while lower color temperatures (2700–3000 K) are called "warm colors" (yellowish).

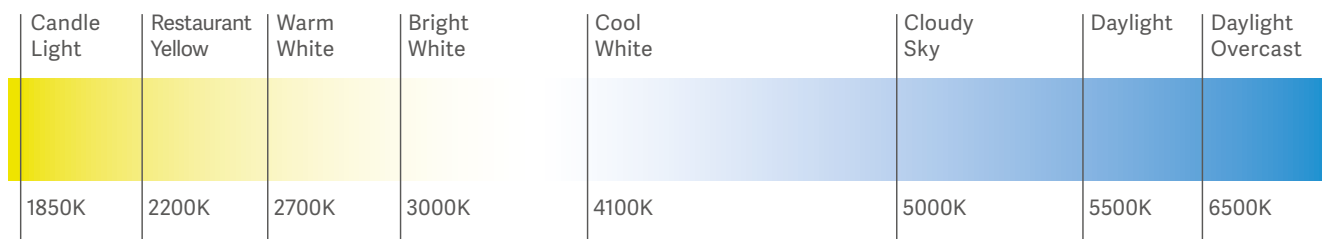

Surgical lights have a color temperature between 3,000K and 6,700K to illuminate in a color-neutral way that supports visibility and diagnostics.

a peaceful light for reddish tissues. Color temperature around 4,500K are considered as whiter and giving cooler colors. But both can give a reliable color tissue restitution, and the tone is a matter of personal preference.

There is no scientific evidence showing that one color temperature is better than another. Color temperatures around 3,800K are considered more yellowish and will give

White light can be produced in different ways through a mix of LEDs or more advanced technologies (wheel filters).

»Light color variations in the illuminated field were noticed when using luminaires that contain differently colored LEDs, either as separate LED units or as differently colored chips in one LED unit«

Standards and Performance Indicators for Surgical Luminaires. Knulst AJ. et al. Leukos. 2009, Vol6 No1 37-49.

Revealing true colors

The CIE color rendering index (CRI or Ra) is a value that represents how well a light source's illumination of eight sample patches compares to the illumination provided by a reference source. It is a measure of the quality of the

light from the perspective of how faithfully the object's colors are perceived. It is measured with an index from 0 to 100, 100 representing sunlight.

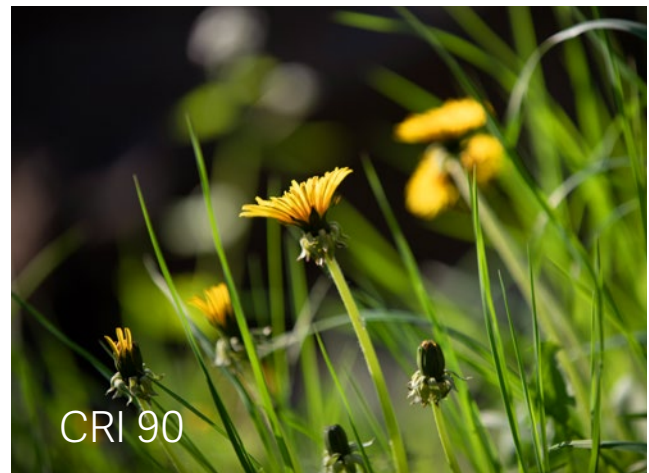
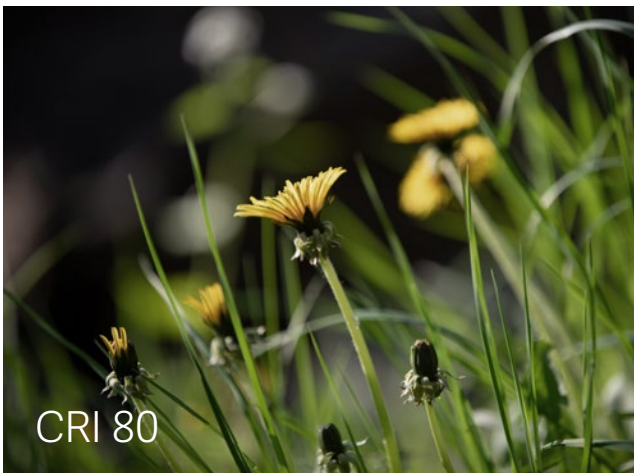

The IEC standard enforces a CRI >85 to allow a faithful color judgment for diagnosis and practitioners' tissue recognition. Above 90, human eyes are not sensitive enough to notice any difference.

Name	Appearance under daylight	Swatch
R1	Light greyish red	
R2	Dark greyish yellow	
R3	Strong yellow green	
R4	Moderate yellowish green	
R5	Light bluish green	
R6	Light blue	
R7	Light violet	
R8	Light reddish purple	

Name	Appearance under daylight	Swatch
R9	Strong red	
R10	Strong yellow	
R11	Strong green	
R12	Strong blue	
R13	Light yellowish pink	
R14	Moderate olive green (leaf)	

The last six samples provide additional information about the color rendering properties of the light source.

The first eight samples are relatively low saturated colors and are evenly distributed over the complete visible range.

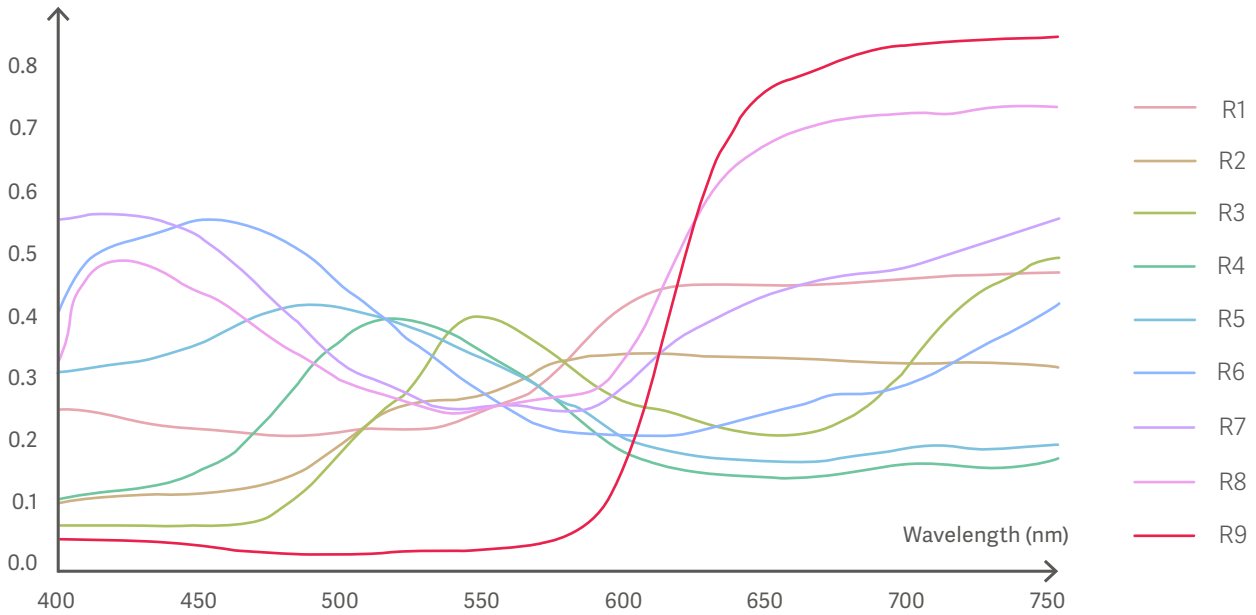

The first eight samples are well distributed along the different wavelengths, whereas the R9 is mostly distributed after 600 nm, where the sensitivity of the human eye is very low.

Human eye sensitivity



Not all wavelengths in the visible are perceived equally by our eyes. Indeed, the eyes' sensitivity curve as a function of the wavelength defined by the ICI (International Commission on Illumination); some wavelengths are better seen than others.

There is no minimum value for R9 in the IEC standard and the results just need to be mentioned. Although the maximum possible value of R9 (strong red) is also 100, unlike average CRI numbers, R9 should be judged a bit differently as the human eye doesn't see that much difference in red hues.

Therefore, an R9 score of 40 or above would be considered "good" while an R9 score of 80 would be considered "excellent".

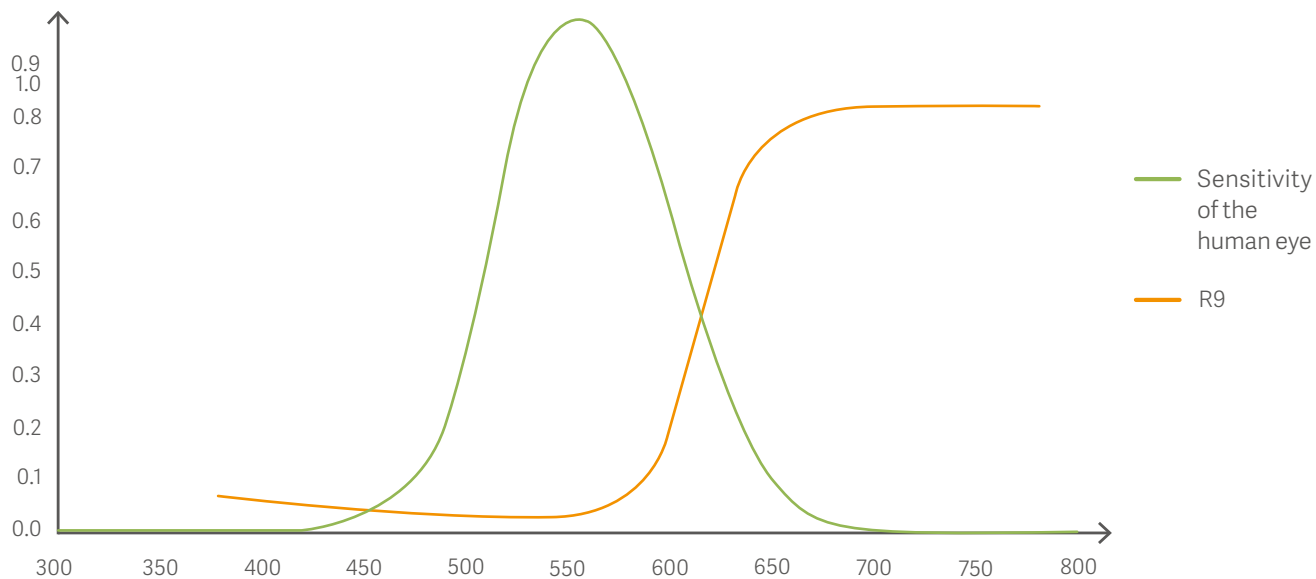

Human eye sensitivity does not allow us to discriminate between an R9 of 40 or 80. A R9 >80 induces wavelengths that increase the heat emission because we enter the wavelengths of the near infrared, without increasing visual efficiency.

Irradiance and patient safety: The connection between light and heat

Light is made of tiny photons which contain lots of energy. This energy travels in waves with the visible light.

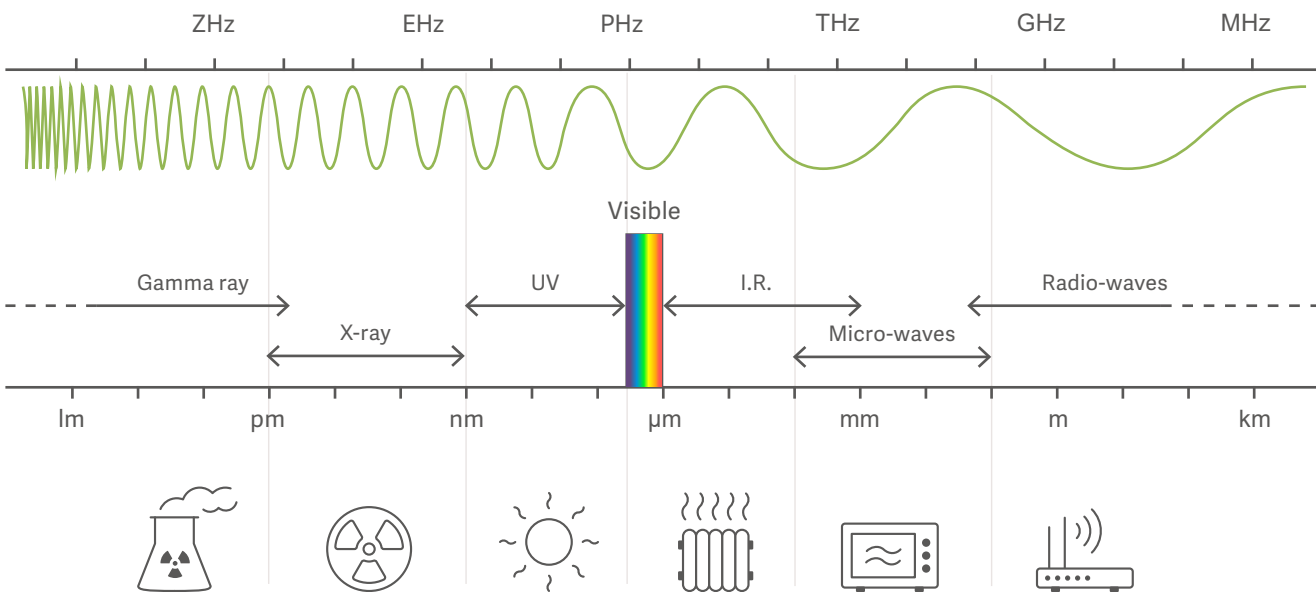

Since light is a source of energy, it produces heat. This heat is generated on two places: on the light field and in the light head.

Heat on light field

In the past, halogen lights used filters to remove infrared wavelengths because they were heating the surgeon's head but also warming patient wounds, causing tissue desiccation, which can play an important role in delaying a patient's recovery.

With LEDs there is no more infrared wavelength projected in the cavity, but some heat still remains in the light field. It is called irradiance. This irradiance is measured in watts per square meter (W/m^2). IEC standards require that surgical lights not exceed $700 W/m^2$ in the lighted area.

Irradiance is calculated by multiplying heat-to-light ratio by light intensity; high intensity will always imply high irradiance.

Light heads can produce an irradiance under $700 W/m^2$ at D_{MI} , but hazards can happen when at least two light fields are overlapped.

A surgical light with a $3.6 mW/m^2/lx$ heat-to-light ratio at $160,000 lx$ will provide $3.6 \times 160,000 = 576,000 mW/m^2 = 576 W/m^2$ irradiance

Using two light heads at $576 W/m^2$ means that patient tissues will receive $1,152 W/m^2$ — exceeding safe limits.



The Manufacture and User facility Device Experience database (MAUDE) and Emergency Care Research Institute (ECRI) reported patient burns because of overlapping high-intensity surgical light fields. These were noticed on patients' skin but can include some tissue desiccation without the knowledge of the surgical staff. It can play a role in patient recovery without any clue that tissues were burned.

To be sure to always operate on the safe side, light heads should not exceed $350 W/m^2$, allowing two light fields to be overlapped safely. The IEC standard recommends advising the surgical staff about the danger of overlapped light fields.

Heat on the light head

When LEDs heat up, it affects their efficiency; light emission decreases as temperature increases. Some smart systems compensate for this by adjusting the current to the temperature.

Light heads radiate heat, which needs to be reduced to avoid hot points and prevent the light head from being too hot when touched, potentially burning staff.

The light head temperature can also affect laminar air flow. A hot spot can produce air disturbances, preventing air flow from directing particles to the floor.

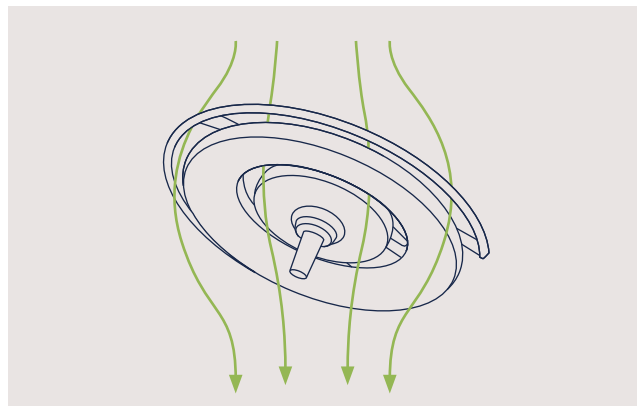

Laminar air flow ceilings are essential in operating theatres to limit the levels of contaminants in the air and thus the risks of post-operative infections for patients. The design of the cupola plays an important role. On the left, a closed cupola shows that the air flow is disturbed, whereas on the right, an open ring design allows controlled heat dissipation, with less interference with less the laminar flow effectiveness.

Single fault safe

Illumination is crucial to OR safety. Single fault safe equipment is designed so that even in single fault condition where no safety hazard exists, the main functions of illumination and maneuverability are preserved. Single fault safe lights have the capability to provide a minimum illuminance (40,000 lx), during a single fault condition and for one seconds of any interruption.

Smart electronics with independent circuits can help ensure single fault safe operation. Double OR light configurations and battery back-ups or mobile versions can further protect against issues.

Lighting overview

A good surgical light must:

- Ensure the best balance of all technical specifications
- Allow good visibility in deep or shallow cavities
- Prevent eyestrain
- Preserve good color rendering to prevent diagnostic confusion
- Prevent tissue desiccation or burns

The best surgical light is the one that medical staff can forget, allowing them to be completely focused on their main tasks.

References

Esser AC, Koshy JG, Randle HW. Ergonomics in office-based surgery: a survey-guided observational study. PubMed—NCBI. Accessed February 19, 2019.

Curlin J, Herman CK, Current State of Surgical Lighting. The Surgery Journal Vol. 6 No. 2/2020.

¹G. Jordan, J.D. Mollon. Adaptation of colour vision to sunlight.. Nature. 386, 135 - 136 (13 March 1997).

² Barneoud J, Breyse JP, Testa R, Dalens H, Coulangeon LM, Michel S. Colour perception in medical environment and under high illuminance levels. CGIP'2000.

³H. Hempälä; G. Johansson, P. Odenrick, K. Akerman and P.A. Larsson. Lighting Recommendations in Operating Theatres. Helsingborg Hospital, Sweden.

⁴Knulst AJ. et al. Standards and Performance Indicators for Surgical Luminaires. Leukos. 2009, Vol6 No1 37-49.

⁵ECRI Institute. Hazard report. Overlap of surgical lighthouse beams may present burn risk. PubMed—NCBI. Available at: <https://www.ncbi.nlm.nih.gov/pubmed/20853770>. Accessed February 19, 2019

This information is intended for an international audience outside the US.

This information is aimed exclusively at healthcare professionals or other professional audiences and are for informational purposes only, is not exhaustive and therefore should not be relied upon as a replacement of the Instructions for Use, service manual or medical advice. Getinge shall bear no responsibility or liability for any action or omission of any party based upon this material, and reliance is solely at the user's risk.

Any therapy, solution or product mentioned might not be available or allowed in your country. Information may not be copied or used, in whole or in part, without written permission by Getinge.

Manufacturer · Maquet S.A.S · Parc de Limère · Avenue de la Pomme de Pin · CS 10008 Ardon · 45074 Orléans, cedex 2 · France

© 2024 Getinge | Getinge and **GETINGE** * are trademarks or registered trademarks of Getinge AB, its subsidiaries or affiliates.
DMS-0007954 | All rights reserved.

GETINGE *